

Sanproject
cod.: 23931
ver.: 01

descrição: tampo de sanita com clipoff e slowclose
description: toilet seat with clipoff and slowclose system
description: abattant pour cuvette avec système clipoff et slowclose

sanindusa®

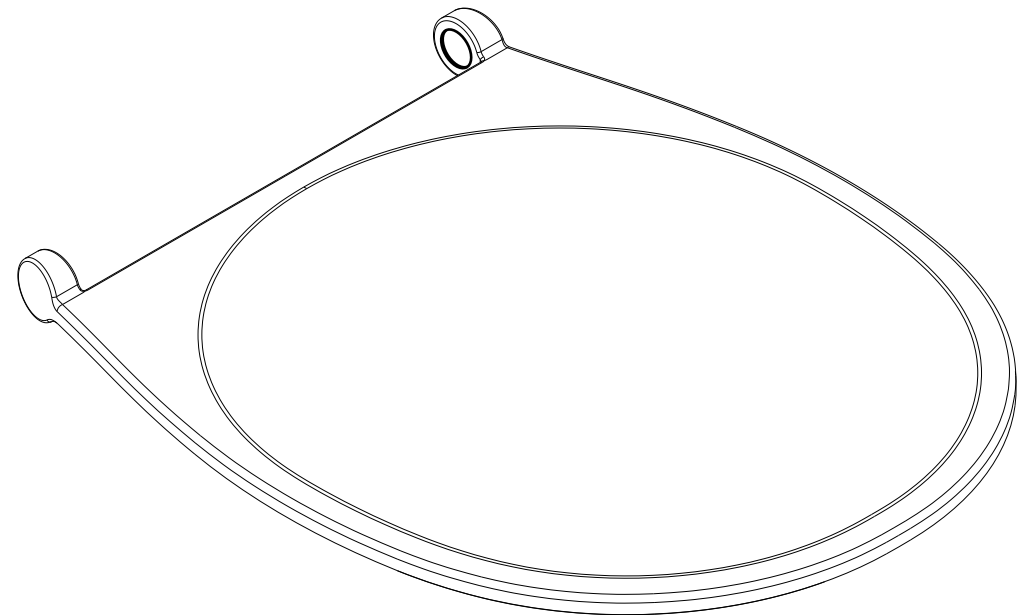
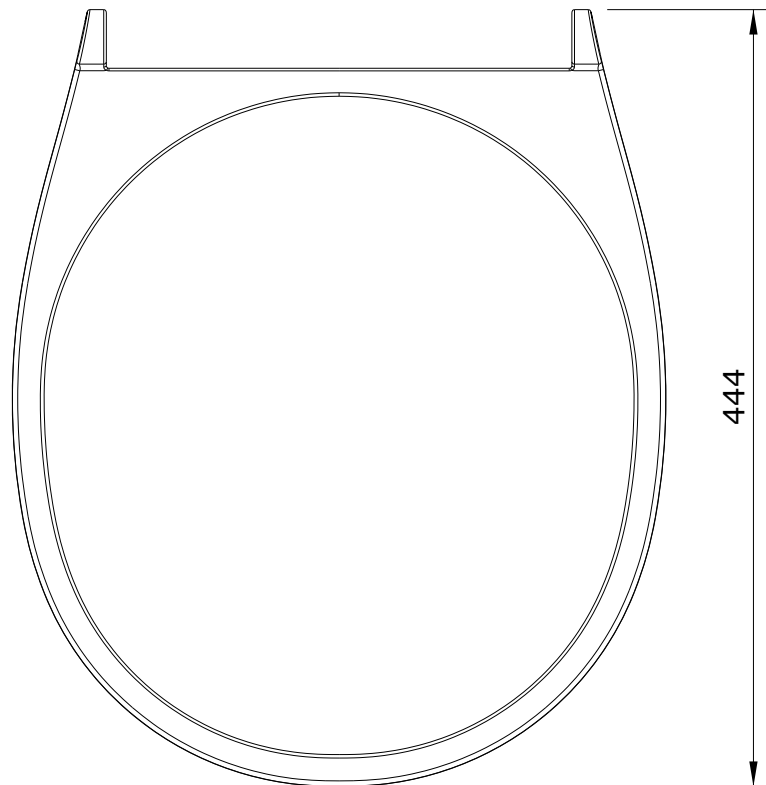
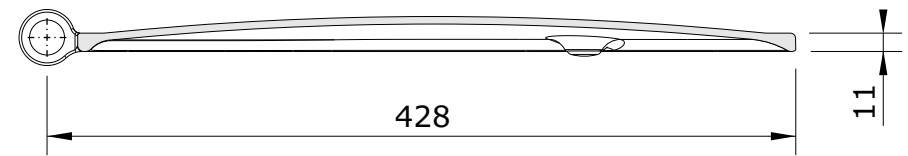
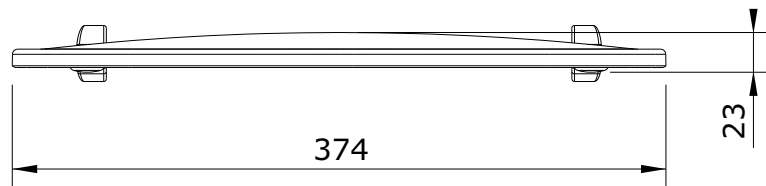

Os produtos apresentados seguem especificações técnicas internas da SANINDUSA.
As dimensões são meramente indicativas.
Reservamos o direito de fazer alterações técnicas que permitam melhorar a funcionalidade dos nossos produtos, sem aviso prévio.

The presented products follow technical specifications from SANINDUSA.
The dimensions of the pieces are merely a reference.
We reserve the right to introduce technical improvements in our products without previous advice.

Les produits présentés suivent les spécifications techniques internes de SANINDUSA.
Les dimensions de ceux-ci sont données à titre indicatifs.
Nous nous réservons le droit de procéder aux modifications techniques qui permettraient d'améliorer les fonctionnalités de nos produits, sans préavis.

Sanproject
cod.: 23931
ver.: 01

descrição: tampo de sanita com clipoff e slowclose
description: toilet seat with clipoff and slowclose system
description: abattant pour cuvette avec système clipoff et slowclose

sanindusa®

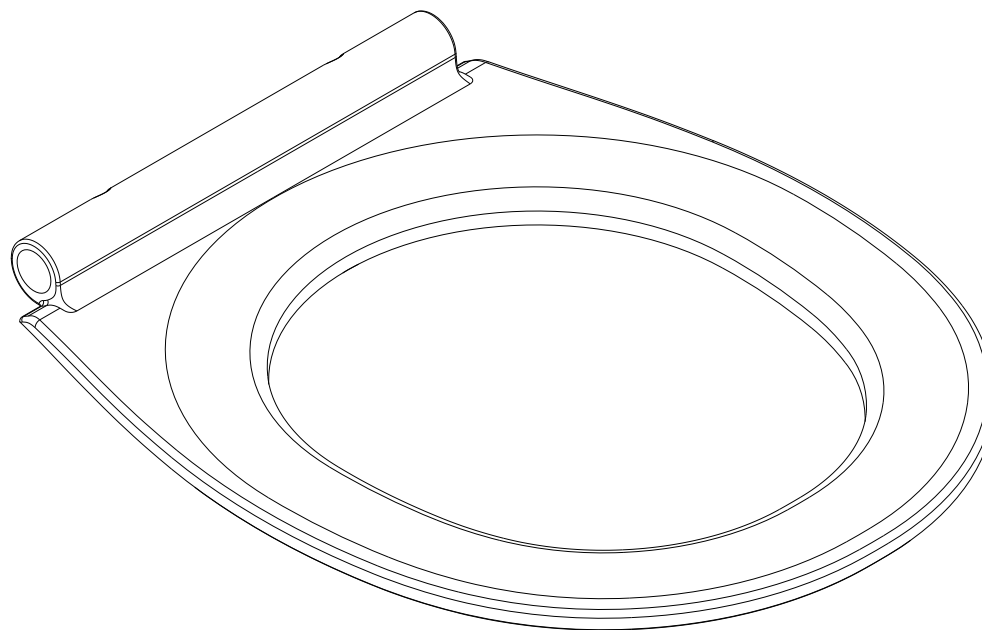
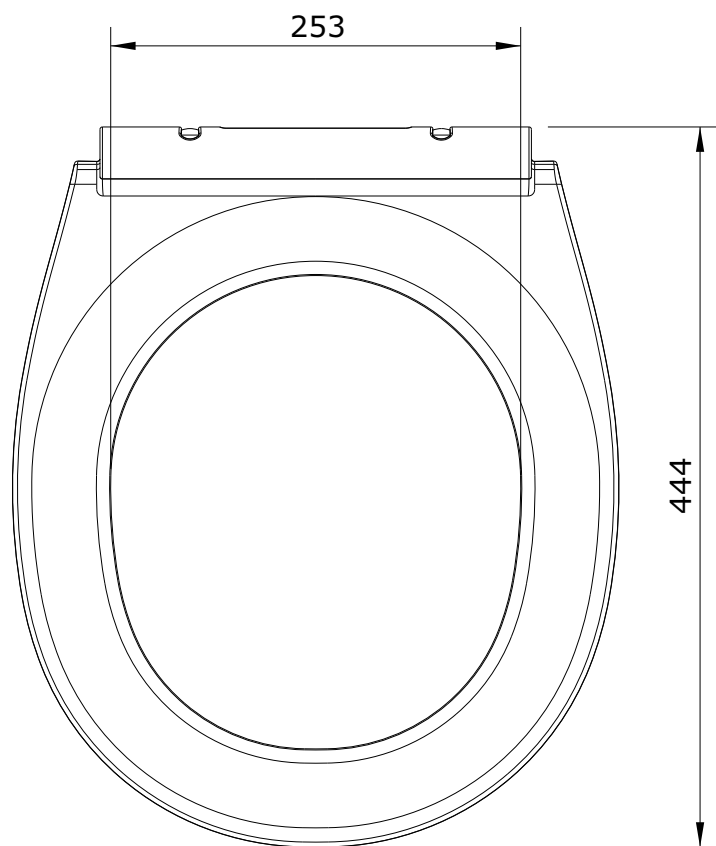
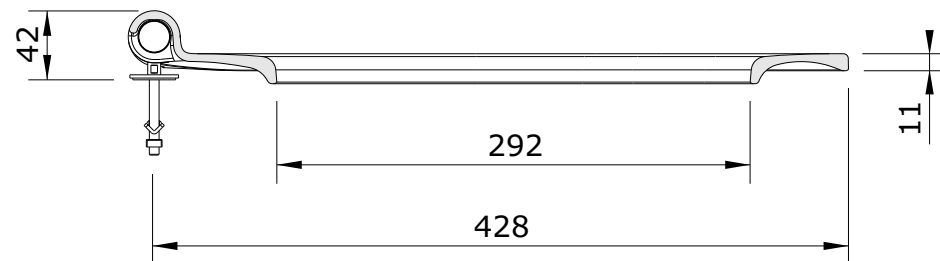
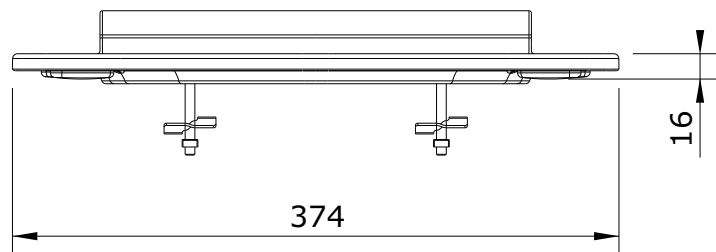

Os produtos apresentados seguem especificações técnicas internas da SANINDUSA.
As dimensões são meramente indicativas.
Reservamos o direito de fazer alterações técnicas que permitam melhorar a funcionalidade dos nossos produtos, sem aviso prévio.

The presented products follow technical specifications from SANINDUSA.
The dimensions of the pieces are merely a reference.
We reserve the right to introduce technical improvements in our products without previous advice.

Les produits présentés suivent les spécifications techniques internes de SANINDUSA.
Les dimensions de ceux-ci sont données à titre indicatifs.
Nous nous réservons le droit de procéder aux modifications techniques qui permettraient d'améliorer les fonctionnalités de nos produits, sans préavis.