

CL II □

IP 44 ▲

V2+V3

12V ~ 50Hz
LED

21,7W - 4000K

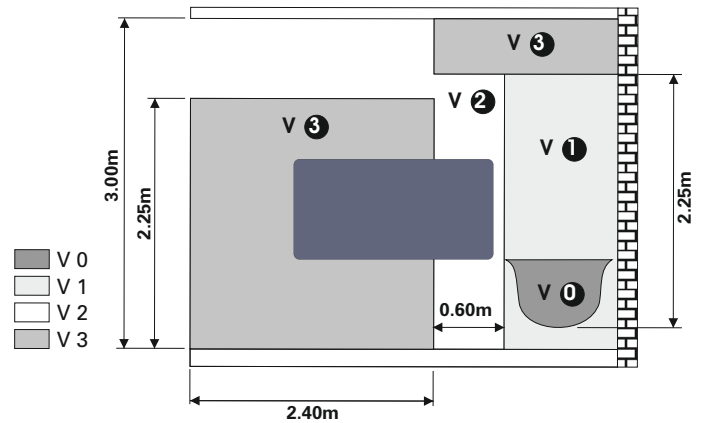
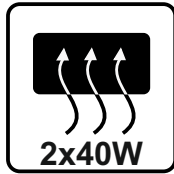

1

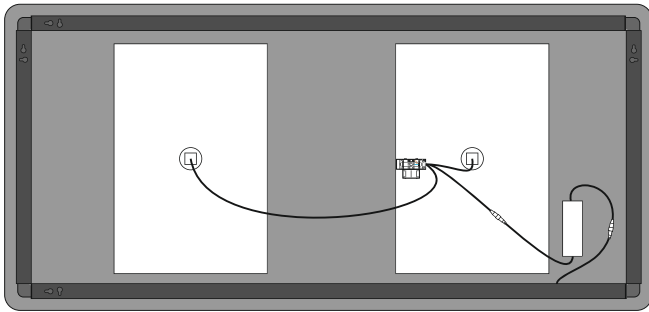

2

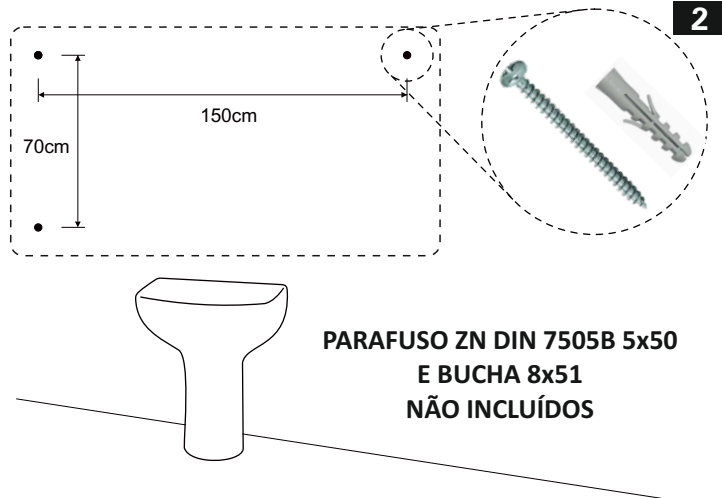

3

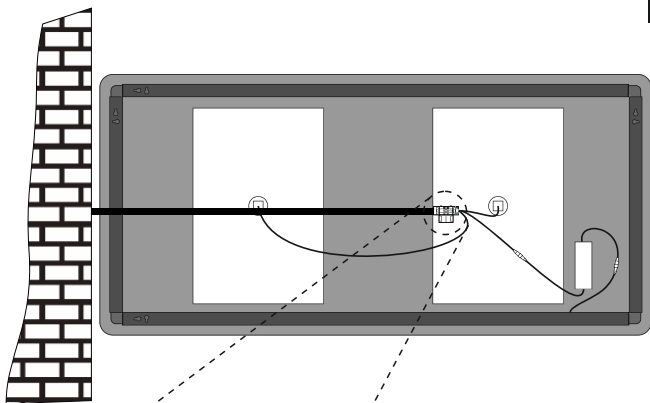

4

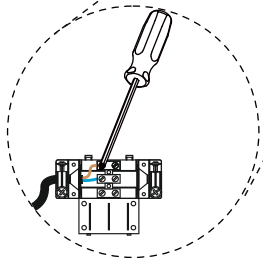
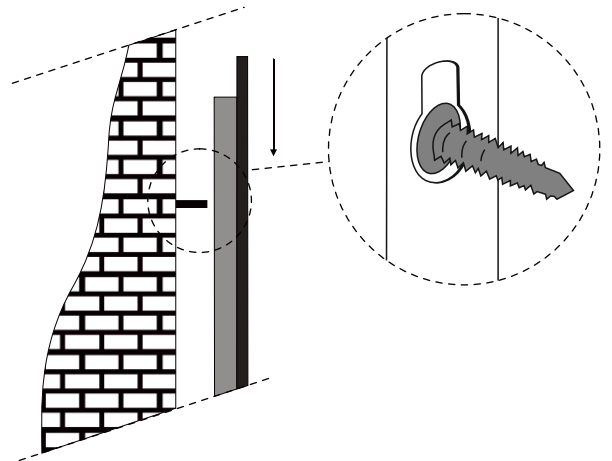

PT O comprimento dos condutores de alimentação deve ser limitado a 8cm de modo a que os condutores sejam completamente cobertos pela manga flexível incorporada na caixa de ligação | Unicamente para uso em interior | O instalador deve garantir o índice de proteção (IP44) bem como o isolamento suplementar entre a alimentação e a superfície de montagem. **EN** The length of the electric conductors must be limited to 8cm in such a way that they are entirely covered by the supple sleeve which is incorporated into the connecting casing | For indoor use only | The installer must adhere to the instructions provided regarding the distance (IP44) as well as insulation between the electricity and the mounting surface. **FR** La longueur des conducteurs d'alimentation doit être limitée à 8cm de manière à ce qu'ils soient entièrement gainés par le manchon souple incorporé au boîtier de raccordement | Pour utilisation intérieure uniquement | L'installateur final doit garantir l'indice de protection (IP44) ainsi que l'isolation supplémentaire entre l'alimentation et la surface de montage. **ES** Los cables de alimentación tienen que tener una longitud máxima de 8cm para que estén totalmente cubiertos por el manguito incorporado a la caja de acoplamiento | Solo para uso interior | El instalador tiene que garantizar el índice de protección (IP44) así como el aislamiento adicional entre la corriente y la superficie de montaje. **IT** La lunghezza dei conduttori elettrici deve essere limitata a 8 cm in modo tale che siano integralmente coperti dal manicotto elastico che è incorporata nel cavo di collegamento | Per uso interno | L'installatore deve rispettare le istruzioni fornite per quanto riguarda la distanza (IP44) e per l'isolamento tra l'elettricità e la superficie di montaggio.