



LA VAGUE

NOTRE SELECTION
DE PRODUITS

THE PATH OF WATER

SANINDUSA



LA VAGUE

INDEX

APPAREILS SANITAIRES

AVEIRO 04

EASY 06

CETUS 08

PROGET CONFORT 10

URB.Y 12

LAVABOS

AVEIRO 18

EASY 19

PARIS 20

RECEVEURS DE DOUCHE

STEP-IN 24

MORAIRA PLUS 26

D-PATH 28

WATERLINE 30

BAIGNOIRES

EASY 34

ROBINETTERIE

EASY 38

BÂTI-SUPPORT

SANEASY 44



APPAREILS SANITAIRES

AVEIRO



AVEIRO

103022 363 x 685 x 402 mm 19,0 kg

Cuvette sortie horizontale avec fixations

103113PF 410 x 180 x 408 mm 13,1 kg

Réservoir avec mécanisme 3/6L alimentation latérale avec fixations

103111LM 410 x 180 x 408 mm 13,3 kg

Réservoir avec mécanisme 3/6L alimentation par le dessous avec fixations

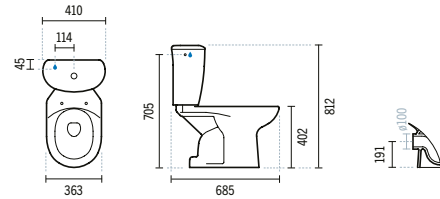

AVEIRO 70

103042 360 x 700 x 345 mm 20,6 kg

Cuvette suspendue 70 cm avec fixations

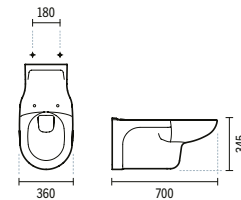

PACKS AVEIRO

| | | |
|---------------|---------------------------|---------|
| 103912 | 103022 + 103113PF + 20314 | 33,9 kg |
| 103914 | 103022 + 103113PF + 20361 | 33,9 kg |
| 103916 | 103022 + 103111LM + 20311 | 33,9 kg |
| 103917 | 103022 + 103113PF + 20311 | 33,9 kg |
| 103922 | 103022 + 103111LM + 20321 | 33,9 kg |
| 103923 | 103022 + 103113PF + 20321 | 33,9 kg |
| 103936 | 103022 + 103111LM + 20314 | 33,9 kg |
| 103938 | 103022 + 103111LM + 20361 | 33,9 kg |

PACKS AVEIRO 70

| | | |
|---------------|----------------|----------|
| 103942 | 103042 + 20311 | 23,17 kg |
|---------------|----------------|----------|



AVEIRO CONFORT

103024 363 x 680 x 455 mm 23,2 kg

Cuvette sortie horizontale avec fixations

103113PF 410 x 180 x 408 mm 13,1 kg

Réservoir avec mécanisme 3/6L alimentation latérale avec fixations

103111LM 410 x 180 x 408 mm 13,3 kg

Réservoir avec mécanisme 3/6L alimentation par le dessous avec fixations

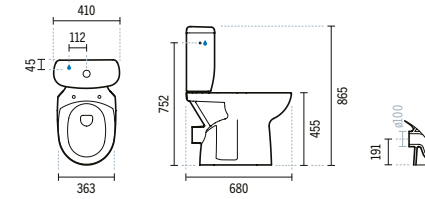

PACKS AVEIRO CONFORT

| | | |
|---------------|---------------------------|---------|
| 103924 | 103024 + 103113PF + 20321 | 41,2 kg |
| 103919 | 103024 + 103113PF + 20361 | 41,2 kg |
| 103925 | 103024 + 103111LM + 20321 | 41,2 kg |
| 103930 | 103024 + 103113PF + 20314 | 41,2 kg |

AVEIRO

ABATTANTS POUR CUVETTE AVEIRO

20314 2,2 kg

Abattant pour cuvette Clipoff avec système Slowclose



20311 2,2 kg

Abattant pour cuvette Clipoff



20321 1,4 kg

Abattant pour cuvette en thermoplast, avec charnières en nylon



20361 1,3 kg

Abattant pour cuvette en thermoplast, avec charnières en acier inoxydable



20361



20314. 20311



20321



EASY



EASY

| | | |
|---------------|--------------------|---------|
| 131024 | 342 x 639 x 390 mm | 24,2 Kg |
|---------------|--------------------|---------|

Cuvette rimflush sortie horizontale avec fixations

| | | |
|-----------------|--------------------|--------|
| 131113LM | 313 x 147 x 380 mm | 9,7 Kg |
|-----------------|--------------------|--------|

Réservoir avec mécanisme 3/6L alimentation latérale avec fixations

| | | |
|-----------------|--------------------|--------|
| 131111LM | 313 x 147 x 380 mm | 9,7 Kg |
|-----------------|--------------------|--------|

Réservoir avec mécanisme 3/6L alimentation par dessous avec fixations

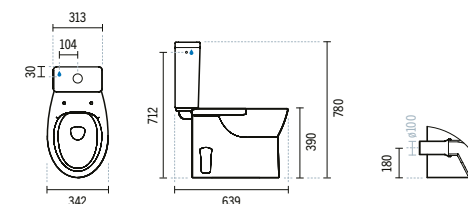

EASY

ABATTANTS POUR CUVETTE EASY

| | |
|--------------|--------|
| 23131 | 2,2 kg |
|--------------|--------|

Abattant pour cuvette en duroplast, avec slowclose et charnières en acier inoxydable



| | |
|--------------|--------|
| 23114 | 2,2 kg |
|--------------|--------|

Abattant pour cuvette en duroplast, avec charnières en acier inoxydable



| | |
|--------------|--------|
| 23121 | 1,8 kg |
|--------------|--------|

Abattant pour cuvette en thermoplast, avec charnières en nylon



23131 . 23114 . 23121

PACKS AVEIRO

| | | |
|---------------|---------------------------|----------|
| 131960 | 131024 + 131113LM + 23121 | 36,35 kg |
| 131920 | 131024 + 131113LM + 23114 | 36,85 kg |
| 131930 | 131024 + 131113LM + 23131 | 36,85 kg |
| 131910 | 131024 + 131111LM + 23114 | 36,85 kg |
| 131914 | 131024 + 131111LM + 23131 | 36,85 kg |



CETUS

CETUS



CETUS 52

110034 370 x 529 x 374 mm 13,6 kg

Cuvette suspendue rimflush 52 cm avec fixations

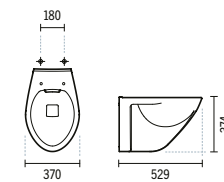

CETUS 48

110044 350 x 489 x 372 mm 13,6 kg

Cuvette suspendue rimflush 48 cm avec fixations

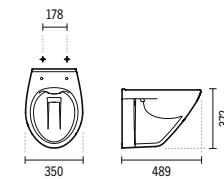

PACKS CETUS 52

110939 110034 + 21031 41,2 Kg

110938 110034 + 21011 41,2 Kg

PACKS CETUS 48

110944 110044 + 21014 41,2 Kg

110946 110044 + 21034 41,2 Kg

ABATTANTS POUR CUVETTE CETUS

21062 1,6 kg

Abattant pour cuvette slim en thermoplast, avec easyclip slowclose et charnières en acier inoxydable



21031 . 21034 2,4 kg . 2,0 kg

Abattant pour cuvette en duroplast, avec clipoff, slowclose et charnières en acier inoxydable



21011 . 21014 2,4 kg . 2,0 kg

Abattant pour cuvette en duroplast, avec clipoff et charnières en acier inoxydable



21021 2,2 kg

Abattant pour cuvette en duroplast, avec clipoff et charnières en nylon



21061 2,3 kg

Abattant pour cuvette en duroplast, avec clipoff, slowclose et charnières en nylon



21062



21011



21014 . 21034



21021 . 21031



21061



PROGET CONFORT



PROGET CONFORT

130022 345 x 675 x 470 mm 30,3 kg

Cuvette sortie horizontale avec fixations

130113LM 370 x 180 x 362 mm 13,8 kg

Réservoir avec mécanisme 3/6L alimentation latérale avec fixations

130111LM 370 x 180 x 362 mm 13,8 kg

Réservoir avec mécanisme 3/6L alimentation par le dessous avec fixations

MSKT1790 0,4 kg

Pipe d'évacuation sortie horizontale Ø100

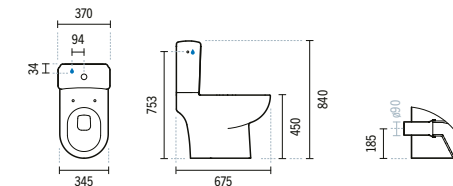

PROGET CONFORT

ABATTANTS POUR CUVETTE PROGET CONFORT

24061 2,8 kg

Abattant pour cuvette slim avec système easyclip et slowclose



23031 1,9 kg

Abattant pour cuvette en duroplast, avec clipoff, slowclose et charnières en acier inoxydable



21411 2,3 kg

Abattant pour cuvette en duroplast, avec charnières en acier inoxydable



24061



23031



21411

PACKS PROGET CONFORT

130924 130022 + 130113LM + 21411 52,3 Kg



URB.Y



URB.Y

140030 362 x 646 x 397 mm 23,2 kg

Cuvette Rimflush sortie horizontale avec fixations

140171LM 360 x 606 x 395 mm 30,2 kg

Réservoir avec mécanisme 3/6L alimentation par le dessous avec fixations

140173LM 360 x 606 x 395 mm 30,2 kg

Réservoir avec mécanisme 3/6L alimentation latérale avec fixations

MSKT1790

Pipe d'évacuation sortie horizontale Ø100

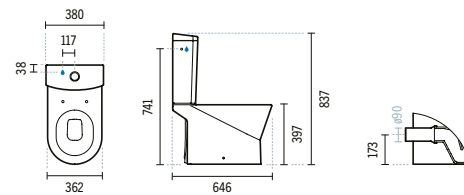

PACKS URB.Y

| | | |
|---------------|---------------------------|-------|
| 140914 | 140030 + 140171LM + 24061 | 52 kg |
| 140915 | 140030 + 140173LM + 24061 | 52 kg |
| 140917 | 140030 + 140171LM + 24031 | 52 kg |
| 140918 | 140030 + 140173LM + 24031 | 52 kg |
| 140910 | 140030 + 140171LM + 24011 | 52 kg |
| 140916 | 140030 + 140173LM + 24011 | 52 kg |



URB.Y 48

140034 350 x 483 x 330 mm 18,8 kg

Cuvette suspendue rimflush 48 cm avec fixations

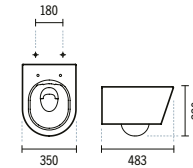

URB.Y 52

140044 350 x 524 x 330 mm 21,6 kg

Cuvette suspendue rimflush 52 cm avec fixations

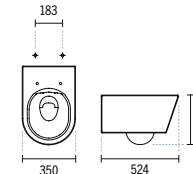

PACKS URB.Y 48

| | | |
|---------------|----------------|-------|
| 140934 | 140034 + 24031 | 21 kg |
| 140935 | 140034 + 24011 | 21 kg |
| 140936 | 140034 + 24061 | 21 kg |

PACKS URB.Y 52

| | | |
|---------------|----------------|----------|
| 140944 | 140044 + 24031 | 24,0 kg |
| 140945 | 140044 + 24011 | 24 kg |
| 140946 | 140044 + 24061 | 24,44 kg |

URB.Y

ABATTANTS POUR CUVETTE URB.Y

24061 2,8 kg

Abattant pour cuvette slim avec système easyclip et slowclose



24031 2,4 kg

Abattant pour cuvette clipoff avec système slowclose



24011 2,4 kg

Abattant pour cuvette clipoff



24061

24031 . 24011



LAVABOS

EASY



AVEIRO

AVEIRO



1 **103300** 550 x 455 x 206 mm 11,5 kg

Lavabo 55
Avec kit de fixation. Avec anneau enjoliveur trop plein.
Non compatible avec semi-colonne.

2 **103310** 595 x 505 x 200 mm 12,5 kg

Lavabo 60
Avec kit de fixation. Avec anneau enjoliveur trop plein.

3 **103200** 224 x 190 x 675 mm 10,5 kg

Colonne

4 **103200** 260 x 315 x 360 mm 7,4 kg

Semi-colonne
Avec kit de fixation.



1 / 2 + 3

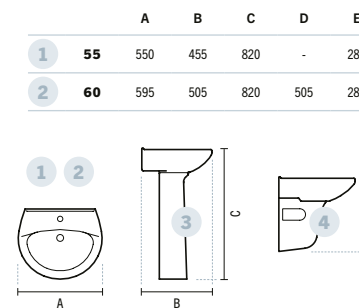

2 + 4

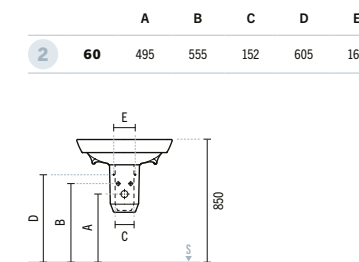

EASY



1 **131330** 500 x 425 x 190 mm 10,8 kg

Lavabo 50
Avec kit de fixation. Sans anneau enjoliveur trop plein.

2 **131310** 548 x 443 x 190 mm 13,4 kg

Lavabo 55
Avec kit de fixation. Sans anneau enjoliveur trop plein.

3 **131320** 612 x 467 x 188 mm 13,5 kg

Lavabo 60
Avec kit de fixation. Sans anneau enjoliveur trop plein.

4 **131200** 172 x 180 x 700 mm 12,8 kg

Colonne

5 **131220** 195 x 310 x 275 mm 7,5 kg

Semi-colonne
Avec kit de fixation.



1 / 2 / 3 + 4

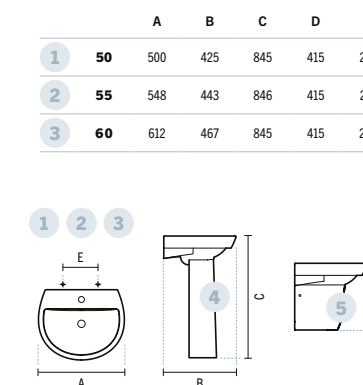

1 / 2 / 3 + 5

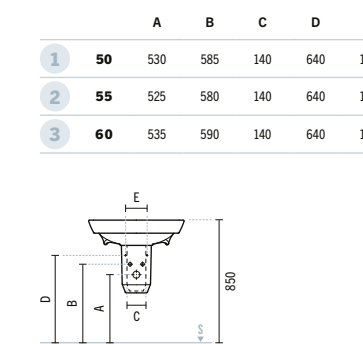



PARIS



108370

550 x 455 x 215 mm 9,3 kg

Vasque à encastrer par le dessus avec percement pour robinetterie.
Avec anneau enjoliveur trop plein.

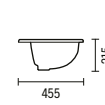
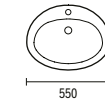



RECEVEURS DE DUCHE

STEPIN



107520 800 x 800 x 35 mm 23,8 kg

80x80
Receveur de douche extra-plat

107520AD 800 x 800 x 35 mm 23,8 kg

80x80
Receveur de douche antidérapant



107530 896 x 900 x 30 mm 26,3 kg

90x90
Receveur de douche extra-plat

107530AD 896 x 900 x 30 mm 26,3 kg

90x90
Receveur de douche antidérapant



ANTIDÉRAPANT

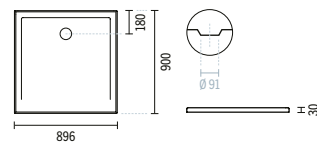
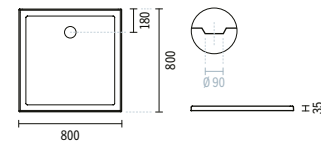

107562 1000 x 700 x 30 mm 24,4 kg

100x70
Receveur de douche extra-plat

107562AD 1000 x 700 x 30 mm 24,4 kg

100x70
Receveur de douche antidérapant

107542 990 x 790 x 30 mm 26,4 kg

100x80
Receveur de douche extra-plat

107542AD 990 x 790 x 30 mm 26,4 kg

100x80
Receveur de douche antidérapant

107552 1195 x 795 x 30 mm 31,8 kg

120x80
Receveur de douche extra-plat

107552AD 1195 x 795 x 30 mm 31,8 kg

120x80
Receveur de douche antidérapant

107612 1194 x 895 x 30 mm 41,2 kg

120x90
Receveur de douche extra-plat

107612AD 1194 x 895 x 30 mm 41,2 kg

120x90
Receveur de douche antidérapant



ANTIDÉRAPANT



STEPIN

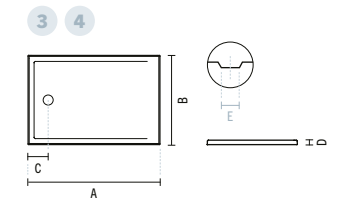
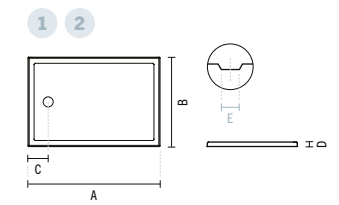

| | A | B | C | D | E |
|---|------|-----|-----|----|-----|
| 1 | 1000 | 700 | 180 | 30 | Ø91 |
| 2 | 990 | 790 | 180 | 30 | Ø90 |
| 3 | 1195 | 795 | 180 | 30 | Ø90 |
| 4 | 1194 | 895 | 250 | 33 | Ø91 |



MORAIRA PLUS

MORAIRA PLUS



107790 798 x 795 x 80 mm 31,0 kg

80x80
Receveur de douche

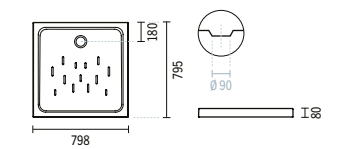

1 **107822** 1190 x 795 x 80 mm 43,9 kg

120x80
Receveur de douche

2 **107832** 1195 x 895 x 80 mm 52,0 kg

120x90
Receveur de douche

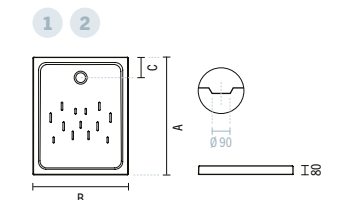

| | A | B | C |
|----------|----|------|-----|
| 1 | 80 | 1190 | 795 |
| 2 | 90 | 1195 | 895 |

D_PATH



107852 899 x 899 x 41 mm 26,3 kg

90x90
Receveur de douche extra-plat sans bord

107852AD 899 x 899 x 41 mm 26,3 kg

90x90
Receveur de douche antidérapant

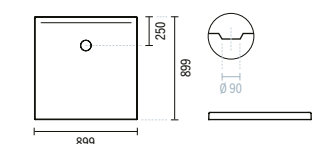

107842 899 x 1200 x 41 mm 41,2 kg

120x90
Receveur de douche extra-plat sans bord

107842AD 899 x 1200 x 41 mm 41,2 kg

120x90
Receveur de douche antidérapant

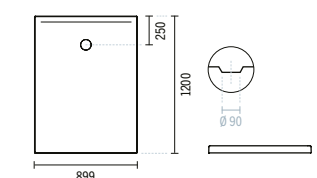

ANTIDÉRAPANT



D_PATH



WATERLINE

WATERLINE



1 **107470** 800 x 800 x 50 mm 27,8 kg

80x80
Receveur de douche extra-plat

2 **107780** 898 x 898 x 45 mm 33,9 kg

90x90
Receveur de douche extra-plat



107742 1198 x 796 x 45 mm 40,5 kg

120x80
Receveur de douche extra-plat

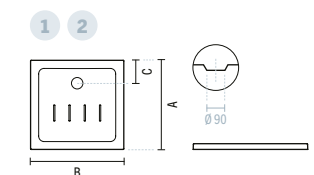

| | A | B | C | D |
|---|----|-----|-----|-----|
| 1 | 80 | 800 | 800 | 180 |
| 2 | 90 | 898 | 898 | 220 |

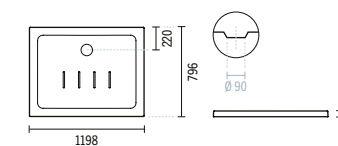



LAVABO

SANINDUSA

EASY

BAIGNOIRE



EASY

EASY



806800 1700 x 700 x 413 mm 18,5 kg

170x70
Baignoire en acrylique

806900 1700 x 750 x 440 mm 21,5 kg

170x75
Baignoire en acrylique

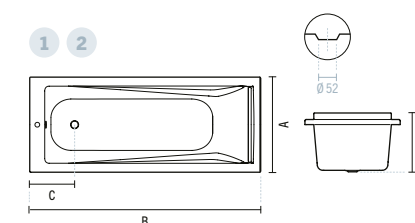

| | A | B | C | D |
|----------|-----------|-----|------|-----|
| 1 | 70 | 700 | 1700 | 330 |
| 2 | 75 | 750 | 1700 | 322 |



ROBINETTERIE

EASY

EASY



5360350NF 50 x 167 x 125 mm 1,6 kg

Mitigeur de lavabo avec tirette latérale et vidage

5360352NF 50 x 167 x 125 mm 1,5 kg

Mitigeur de lavabo avec tirette latérale et vidage en ABS

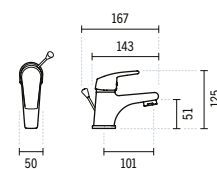

5360381 50 x 161 x 137 mm 1,7 kg

Mitigeur bain/douche monotrou

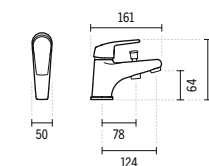

5360801 220 x 171 x 118 mm 2,3 kg

Mitigeur bain/douche avec douchette

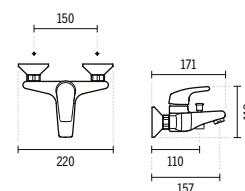

5360701 220 x 145 x 107 mm 1,8 kg

Mitigeur de douche avec douchette

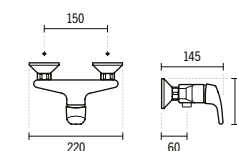



EASY

EASY

**5363001**

Ø45 x 230 x 163 mm 1,5 kg

Mitigeur de cuisine à bec orientable

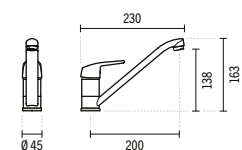



BÂTI-SUPPORT

Installation et Accessibilité Aisées

Les structures, les réservoirs et les plaques ont été conçus pour faciliter leur installation et les opérations de maintenance. La plupart des plaques peuvent être assemblées sans outils et leur retrait permet un accès direct à l'intérieur des toilettes.

Stabilité et Solidité

Les systèmes de fixation qui accompagnent les structures assurent la stabilité et la fiabilité des installations dans le temps, et les tests effectués confirment le support d'une charge d'au moins 400 Kg.

Économie D'espace

L'installation d'appareils sanitaires suspendus permet de gagner de l'espace dans la salle de bains tout en apportant une sensation d'espace aux petits environnements.

Hygiène et Propreté

En libérant le sol de toute obstruction, les installations de cuvettes et de bidets suspendus rendent la tâche de nettoyage de la salle de bains plus facile, plus efficace et plus rapide.

L'économie des Ressources

Les systèmes de chasse d'eau interruptible et double touche permettent d'économiser l'eau, de valoriser les ressources naturelles et de réduire les coûts de consommation.

**462NF**

1150 x 500 x 160-250 mm

Bâti-support pour cuvette suspendue

4A62

Système Coupe-feu pour bâti-support

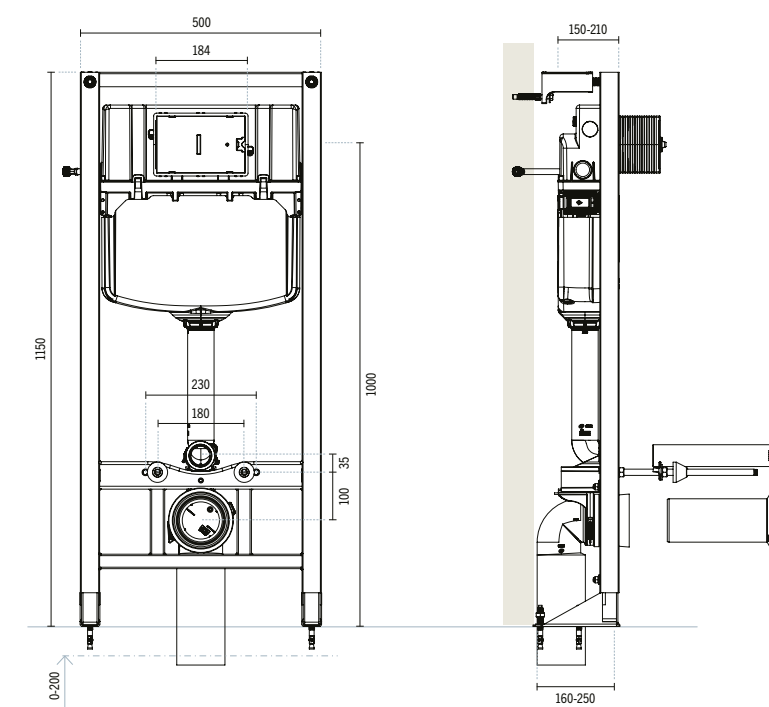

SANEASY

4620

230 x 150 x 6,5 mm

Narrow

Plaque PL pour réservoir encastré à double chasse

COULEURS DISPONIBLES

10 – Blanche



11 – Chromée



26 – Noir mate

PACKS URB.Y 48

140901 140034 + 24061 + 462NF + 462010

PICTOGRAMMES



RIM
FLUSH



+5CM
CONFORT



DOUBLE CHASSE 3/6L



SUSPENDUE



FIXATION SUPÉRIEURE



PVC



ANTIBACTÉRIEN



SLOWCLOSE



CLIP OFF



ECOSPOT



COLDOPEN



C3



DÉBIT D'EAU



CAPACITÉ (L)



EXTRA-PLAT



ANTIDERRAPANT



À POSER



À ENCASTRER



SURFACE NON-ÉMAILLÉ

BUILT FOR LONGEVITY  DESIGNED FOR TRUST

100%
MADE IN PORTUGAL

Nous sommes **100% fabriqués au Portugal**.
Chaque jour, nous produisons et exportons des produits nationaux dans **le monde**.
Nous sommes fiers de ce que nous faisons et nous contribuons ainsi à améliorer la **compétitivité**, à créer des **emplois** et à promouvoir une **économie plus durable**, notamment en **réduisant l'empreinte environnementale**.

Pour consulter les certificats NF, veuillez contacter Sanindusa ou visiter le site web de la marque **sanindusa.pt**



www.virlato.com.pt
09-2023

SANINDUSA

THE PATH OF WATER

Z.I. Aveiro Sul . P.O.Box 43
3811-901 Aveiro, Portugal
+351 234 940 250

(CHAMADA P/ A REDE FIXA NACIONAL . PORTUGUESE LANDLINE NETWORK CALL)

sanindusa.pt . sanindusa@sanindusa.pt

