

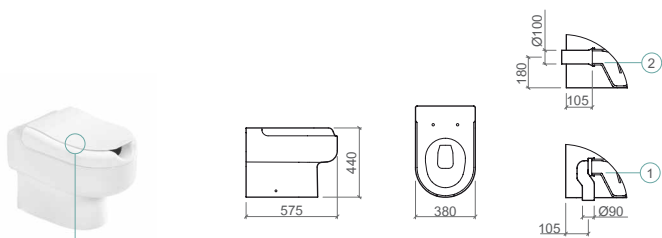

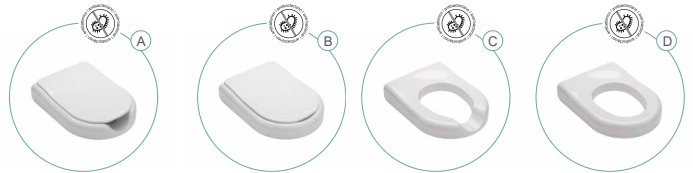

# NEW WCCARE

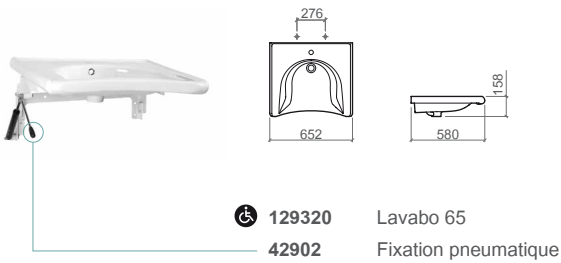

-  ① **129011** Cuvette simple S/V
-  ② **129012** Cuvette simple S/H
- Ⓐ **22911** Réhausseur surdécoupé duroplast avec abattant et charnières inox
- Ⓐ **22931** Réhausseur duroplast avec abattant slowclose et charnières inox
- Ⓑ **22951** Abattant duroplast avec charnières inox
- Ⓑ **22961** Abattant duroplast slowclose avec charnières inox
- Ⓒ **2291100A** Réhausseur duroplast surdécoupé à l'avant avec charnières inox
- Ⓓ **2295100A** Réhausseur duroplast avec charnières inox

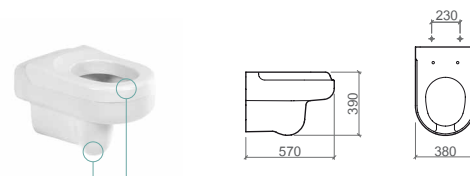

-  **129032** Cuvette suspendue
- Ⓐ **22911** Réhausseur surdécoupé duroplast avec abattant et charnières inox
- Ⓐ **22931** Réhausseur duroplast avec abattant slowclose et charnières inox
- Ⓑ **22951** Abattant duroplast avec charnières inox
- Ⓑ **22961** Abattant duroplast slowclose avec charnières inox
- Ⓒ **2291100A** Réhausseur duroplast surdécoupé à l'avant avec charnières inox
- Ⓓ **2295100A** Réhausseur duroplast avec charnières inox

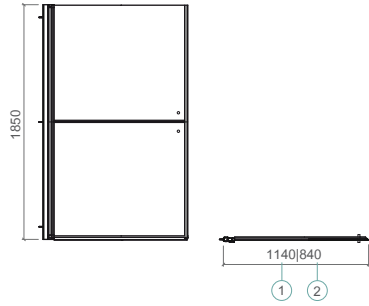

- ① **891910** Cabine de douche - porte 120x185
- ② **891920** Cabine de douche - porte 90x185

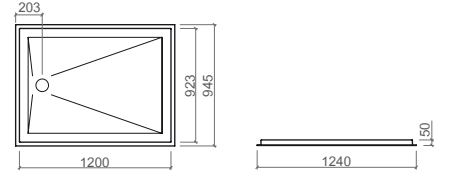

- ⑤ **800900** Receveur de douche 120x90
- 49911** Vidage Ø90



- ⑤ **42969** Miroir d'inclinaison réglable

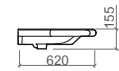
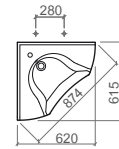

- ⑤ **129700** Lavabo d'angle



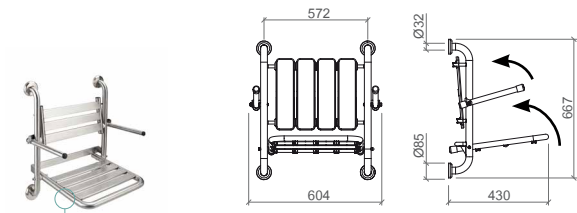

**42946** Siège pliant pour douche avec dossier et accoudoirs

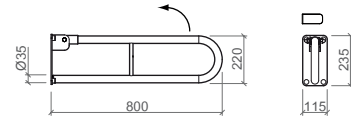

**42964** Barre d'appui pliante 80

**42963** Barre d'appui pivotante et rebattable 80

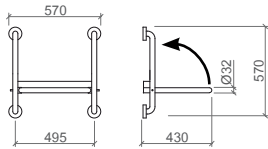

**42948** Siège pliant pour douche

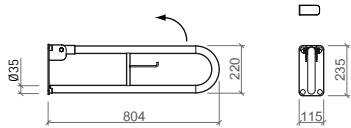

**42968** Barre d'appui pliante 80 avec distributeur de papier

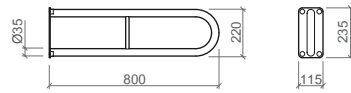

**42962** Barre d'appui fixe 80

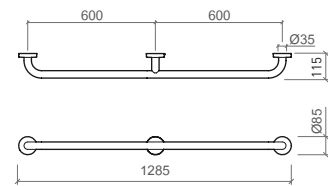

**42966** Barre d'appui 120

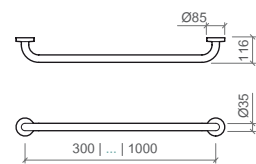

**42972** Barre d'appui 100

**42953** ... Barre d'appui 90

**42971** ... Barre d'appui 80

**42970** ... Barre d'appui 70

**42952** ... Barre d'appui 60

**42951** ... Barre d'appui 45

**42950** Barre d'appui 30

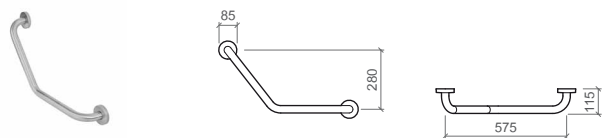

**42954** Barre d'appui d'angle 130°

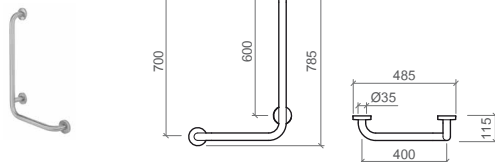

**42960** Barre d'appui d'angle 90° droit  
**42961** Barre d'appui d'angle 90° gauche

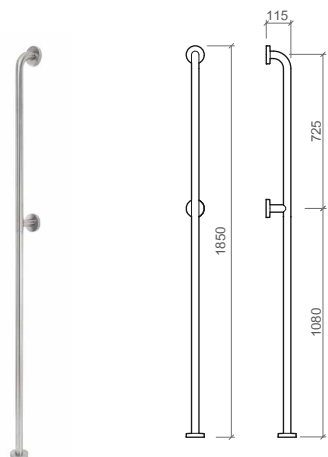

**42967** Barre d'appui

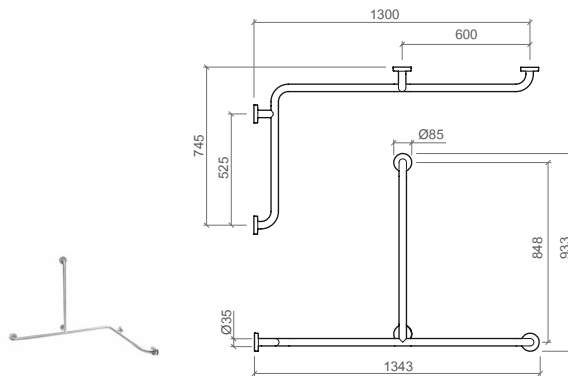

**42959** Barre d'appui d'angle

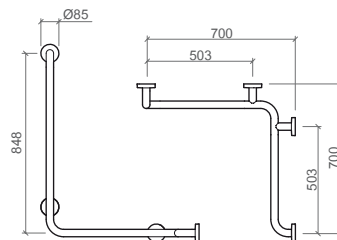

**42958** Barre d'appui d'angle

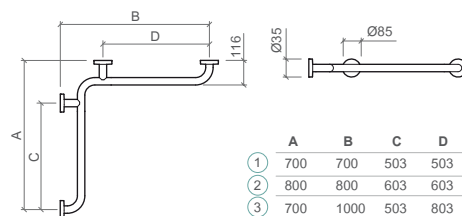

**42957** Barre d'appui d'angle 70x100  
**42956** Barre d'appui d'angle 80x80  
**42955** Barre d'appui d'angle 70x70

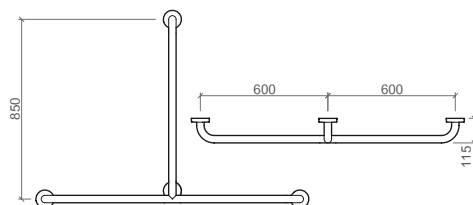

**42965** Barre d'appui d'angle

## PROGET CONFORT

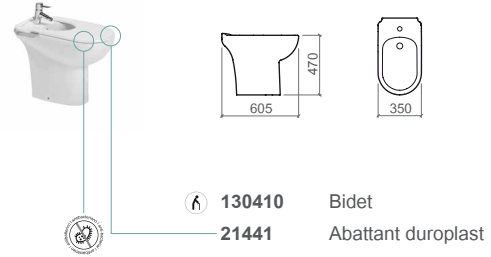

- 130410 Bidet
- 21441 Abattant duroplast

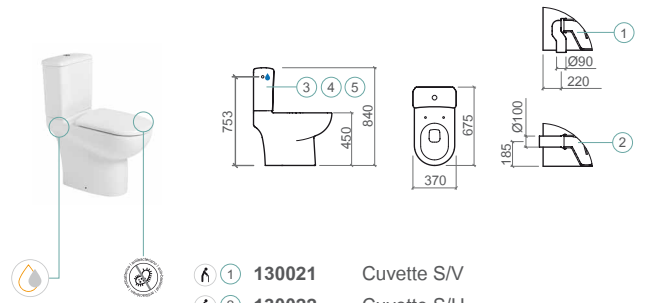

- 1 130021 Cuvette S/V
- 2 130022 Cuvette S/H
- 3 130111 Réservoir
- 4 130113 Réservoir [AL]
- 5 130113LM Réservoir équipé de mécanisme [AL]
- 21411 Abattant duroplast avec charnières inox



- 130923 Pack Proget Confort  
(Avec: cuvette monob. S/V, réservoir équipé de mécanisme (AL), abattant thermoplast)
- 130924 Pack Proget Confort  
(Avec: cuvette monob. S/H, réservoir équipé de mécanisme (AL), abattant thermoplast)

## AVEIRO CONFORT

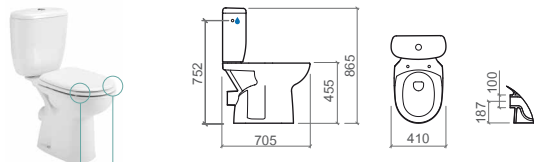

- NF 103024 Cuvette S/H
- 103111 Réservoir
- 103111PF Réservoir équipé de mécanisme [AI]
- NF 103113 Réservoir [AL]
- NF 103113PF Réservoir équipé de mécanisme [AL]
- 20331 Abattant duroplast slowclose avec charnières inox
- 20320 Abattant duroplast avec charnières inox
- 20321 Abattant en thermoplast avec charnières en nylon
- 20361 Abattant en thermoplast avec charnières en métal
- 103919 Pack Aveiro Confort  
(Avec: cuvette monob. S/H, réservoir (AL), mécanisme 3/6L NF, abattant thermoplast avec charnières en métal)
- 103924 Pack Aveiro Confort  
(Avec: cuvette monob. S/H, réservoir (AL), mécanisme 3/6L, abattant thermoplast avec charnières en métal)
- 103925 Pack Aveiro Confort  
(Avec: cuvette monob. S/H, réservoir (AL), mécanisme 3/6L, abattant thermoplast avec charnières en métal)
- 103930 Pack Aveiro Confort  
(Avec: cuvette monob. S/H, réservoir (AI), mécanisme 3/6L NF, abattant duroplast avec charnières inox)



## AVEIRO

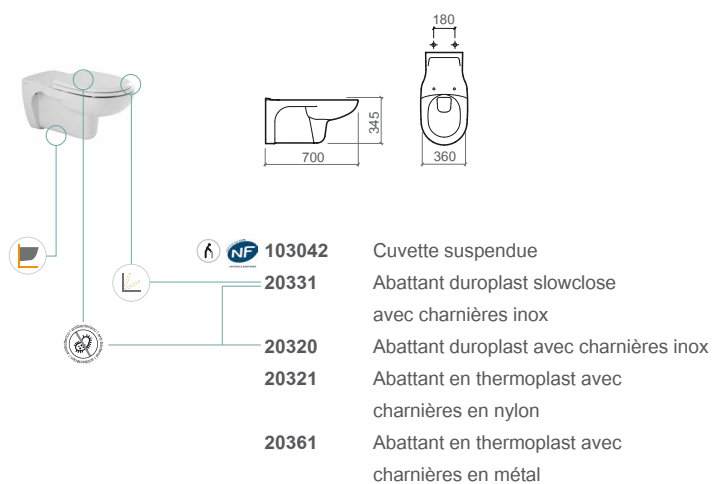

## CETUS

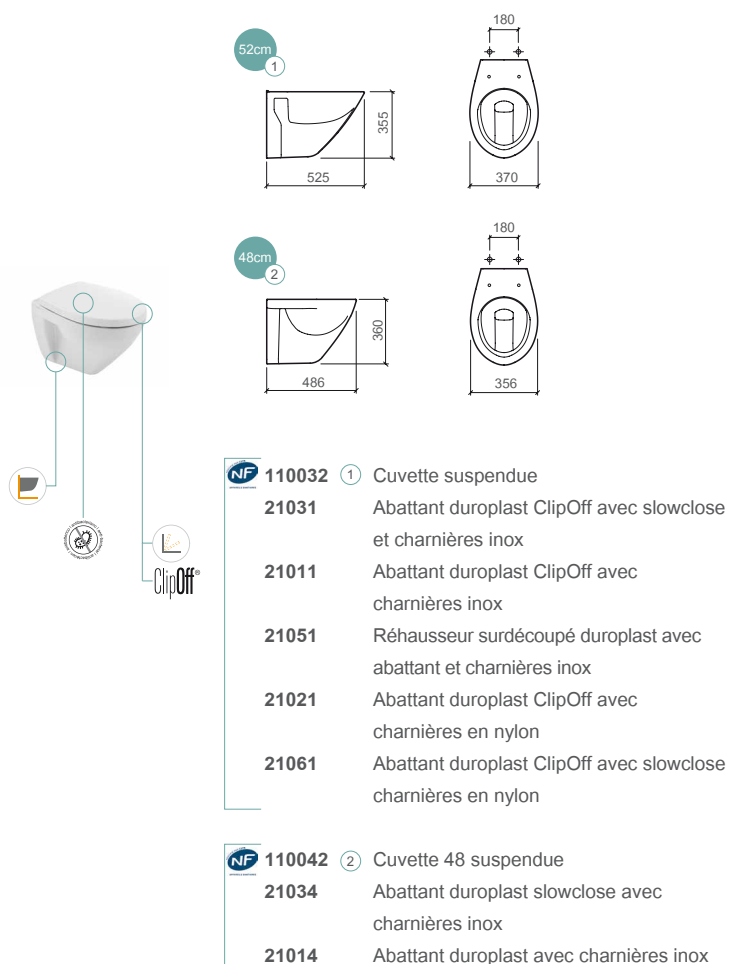

# STEPIN

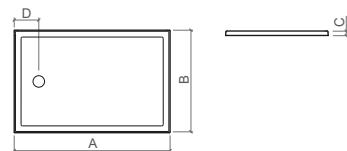
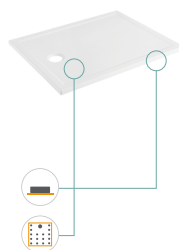
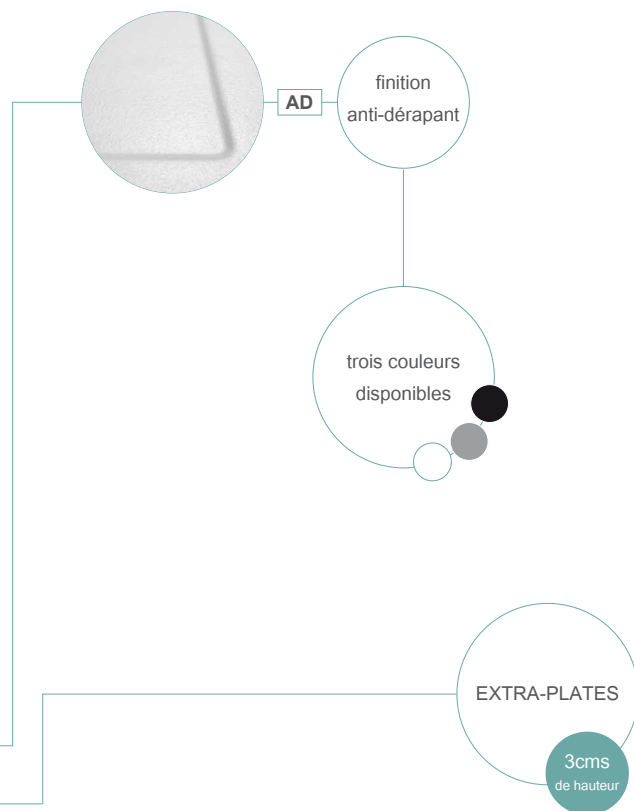
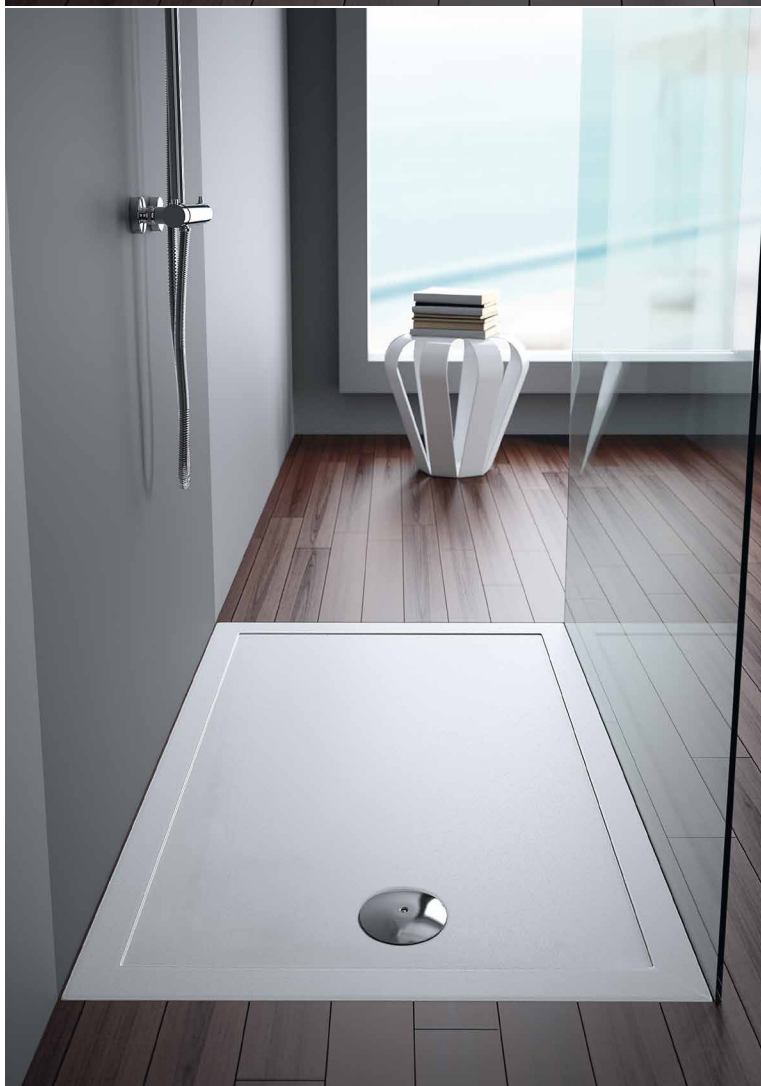

		A	B	C	D		
①	<b>107562</b>	100	1000	700	30	180	<b>107562 AD</b>
②	<b>107542</b>	100	1000	800	30	180	<b>107542 AD</b>
③	<b>107572</b>	120	1200	700	30	180	<b>107552 AD</b>
④	<b>107552</b>	120	1200	800	30	180	<b>107572 AD</b>
⑤	<b>107612</b>	120	1200	900	35	250	<b>107612 AD</b>

- ① Receveur de douche 100x70
  - NF** ② Receveur de douche 100x80
  - ③ Receveur de douche 120x70
  - ④ Receveur de douche 120x80
  - ⑤ Receveur de douche 120x90
- 49911 Vidage Ø90**

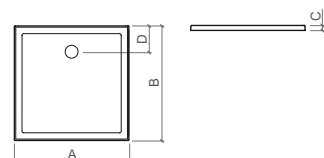
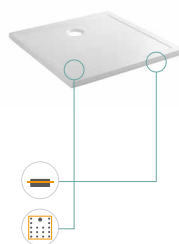

		A	B	C	D		
①	<b>107520</b>	80	800	800	30	180	<b>107520 AD</b>
②	<b>107530</b>	90	900	900	35	180	<b>107530 AD</b>

- NF** ① Receveur de douche 80x80
  - ② Receveur de douche 90x90
- 49911 Vidage Ø90**



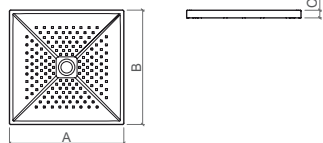
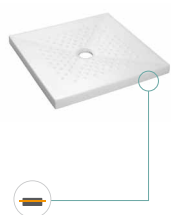

		A	B	C
①	<b>107245</b>	80	800	800
②	<b>107255</b>	90	900	900

 ① Receveur de douche 80x80

 ② Receveur de douche 90x90

**49911** Vidage Ø90



# VIDOIR D'HÔPITAL

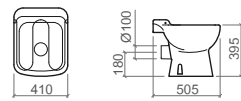

**118610** Vidoir d'hôpital

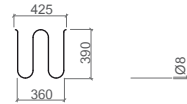

**4A1861** Grille

# BLINK

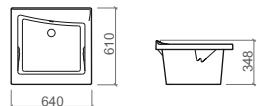

**108640** Bac à laver  
**4640** Vidage

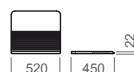

**6600678** Planche à laver en bois

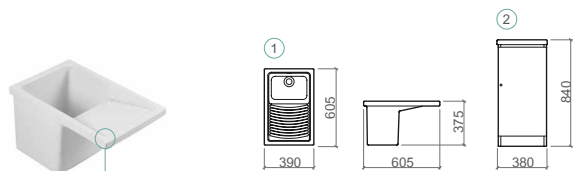

① **108600** Bac à laver 40  
 ② **66040** Meuble 40

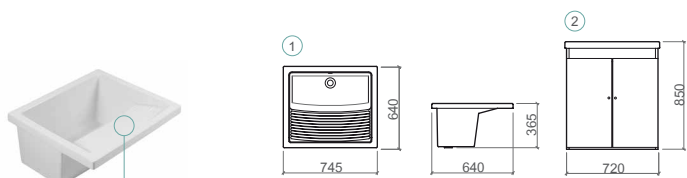

① **108630** Bac à laver 75  
 ② **66340** Meuble 75





antibacteriéne



mobilité réduite



sénior



certification NF



slowclose



suspendue



double discharge



à poser



à encastrer



anti-dérapant

Sanindusa - Indústria de Sanitários S.A.  
Zona Industrial Aveiro Sul  
Apartado 43  
3811-901 Aveiro, Portugal

T. +351 234 940 250  
F. +351 234 940 266  
sanindusa@sanindusa.pt

**Sanindusa France**  
30 Rue Magressolles  
31780 Castel Ginest  
France

T. 0668506218  
sanindusafrance@orange.fr

www.tec.sanindusa.pt  
www.sanindusa.pt

**sanindusa**  
GRUPO



www.departiraloica.com



sanindusa



sanindusa



sanindusa.portugal



sanindusa



sanindusasanitarios

