

moments
LIFE

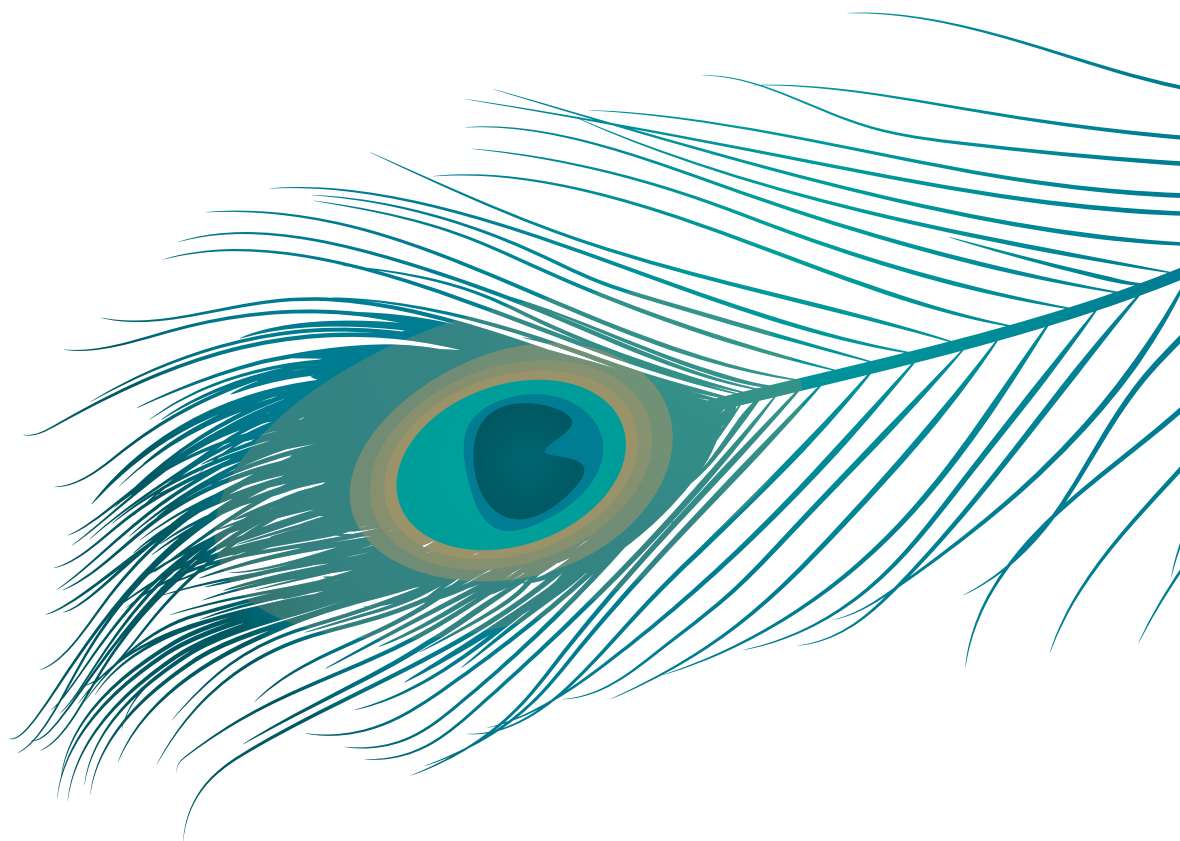



“100% Portuguese roots”

*“raízes 100% portuguesas”
“racines 100% portugaises”
“raíces 100% portuguesas”*

Há mais de **25 anos** que a **Sanindusa** é reconhecida pelos seus produtos de referência nos ambientes de **salas de banho** e de **cozinha**.

Desde cedo a aposta recaiu na inovação e orientação para o cliente, conquistando a confiança pela transparência e rigor que imprime em todos os seus projetos. Com **raízes 100% portuguesas**, o grupo, constituído por 5 polos de produção, aposta na exportação levando a sua imagem de marca e **alma portuguesa** aos 4 cantos do mundo.

O **design arrojado e inovador** é o denominador comum das suas criações e a **preocupação ecológica** assina uma gama considerável de peças.

A aposta constante nas tecnologias tem permitido atingir um posicionamento vanguardista, proporcionando retorno ao investimento e assegurando a continuidade **presente e futura** da empresa nascida em 1993.



For more than **25 years** **Sanindusa** has been recognized for its high-quality **bathroom** and **kitchen** products.

From early on the main focus was on innovation and customer orientation through the transparency and precision encompassed in all their projects. Sanindusa's group consists of 5 production units and has **100% Portuguese roots**. The company wants to take its brand image and soul to the four corners of the world.

Their **bold** and **innovative design** is the common denominator of their creations and **ecological concerns** which are combined into their range of products. The constant investment in technology allowed the company to achieve a pioneering position which provides investment return and ensures the **present and future** continuity of the group since 1993.

Depuis plus de **25 ans**, **Sanindusa** est reconnu pour ses produits de référence dans les environnements de **salle de bains** et de **cuisine**.

Dès le début, l'accent a été mis sur l'innovation et l'orientation client, ce qui lui a valu la confiance pour la transparence et la rigueur qu'elle imprime à tous ses projets. Avec des **racines 100% portugaises**, le groupe, composé de 5 pôles de production, parie sur l'exportation en portant son image de marque et son âme portugaise aux 4 coins du monde. Le **design audacieux** et **innovant** est le dénominateur commun de ses créations et le **souci écologique** signe une gamme considérable de pièces. L'investissement constant dans la technologie nous a permis d'atteindre une position avant-gardiste, assurant un retour sur investissement et garantissant la continuité **présente et future** de l'entreprise née en 1993.

Durante más de **25 años** **Sanindusa** ha sido reconocida por sus productos de referencia en los **ambientes de baño y cocina**.

Desde sus inicios, se centró en la innovación y la orientación al cliente, ganándose la confianza por la transparencia y el rigor que imprime en todos sus proyectos. Con **raíces 100% portuguesas**, el grupo, compuesto por 5 puntos de producción, apuesta por la exportación llevando su imagen de marca y su alma portuguesa a los 4 rincones del mundo.

El **diseño audaz e innovador** es el denominador común de sus creaciones y la **preocupación ecológica** firma una considerable gama de piezas. La constante inversión en tecnología nos ha permitido alcanzar una posición de vanguardia, proporcionando un retorno de la inversión y asegurando la continuidad **presente y futura** de la empresa nacida en 1993.

“a perfect symbiosis of colours, materials and shapes”

“simbiose perfeita entre cores, materiais e formas”

“symbiose parfaite entre les couleurs, les matériaux et les formes”

“simbiosis entre colores, materiales y formas”

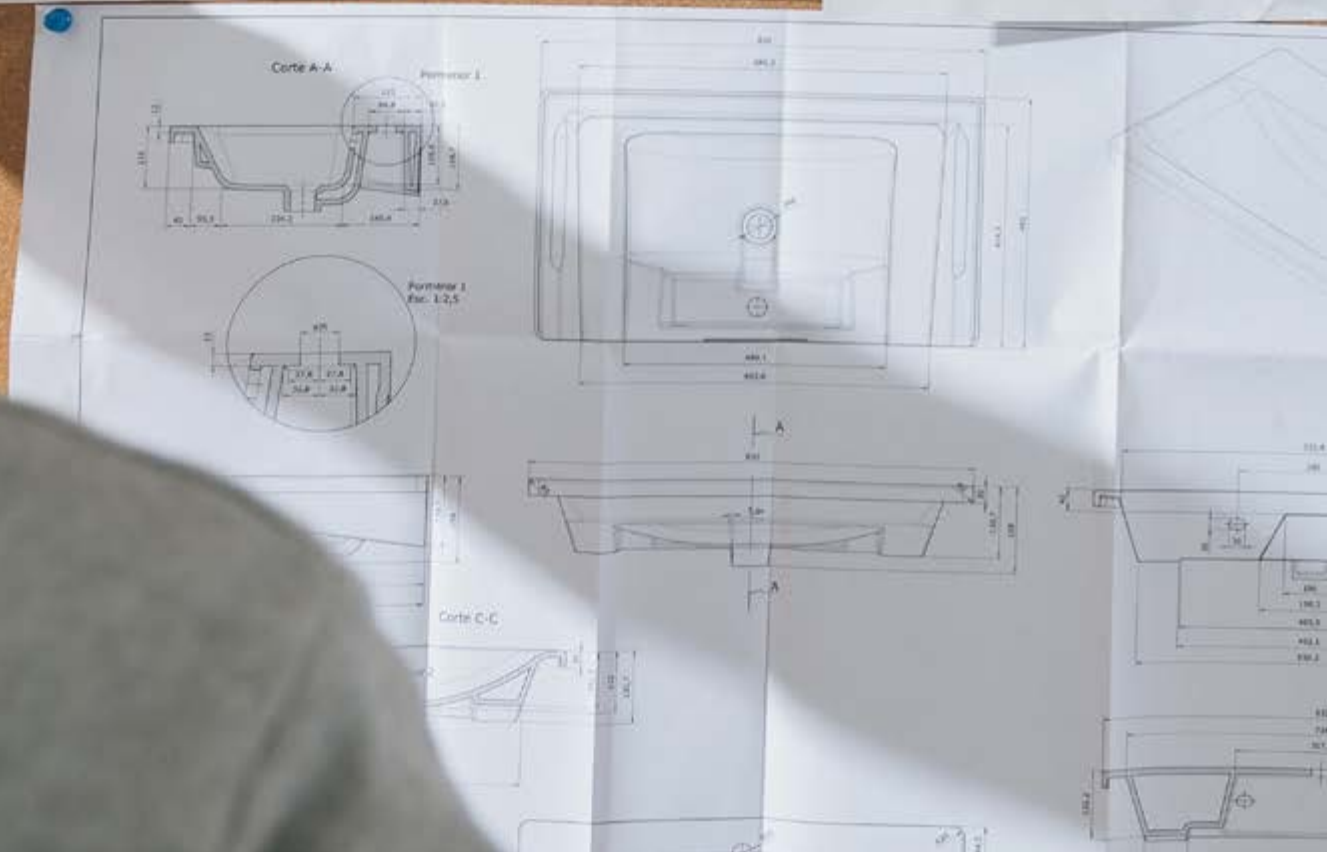
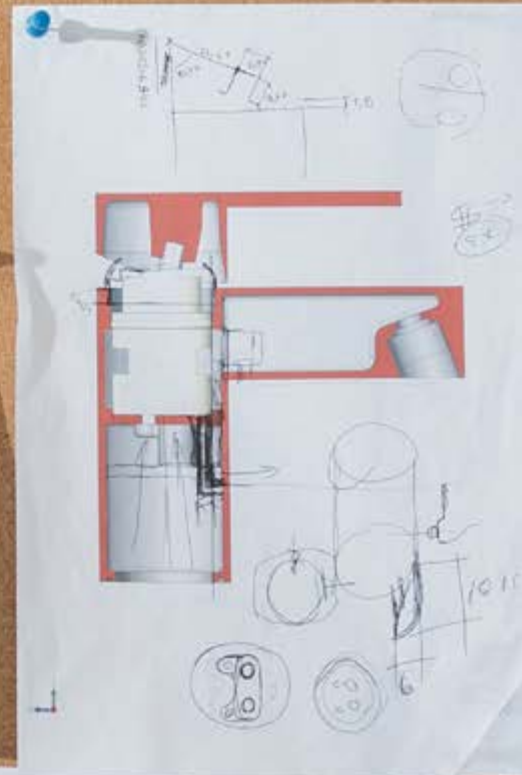
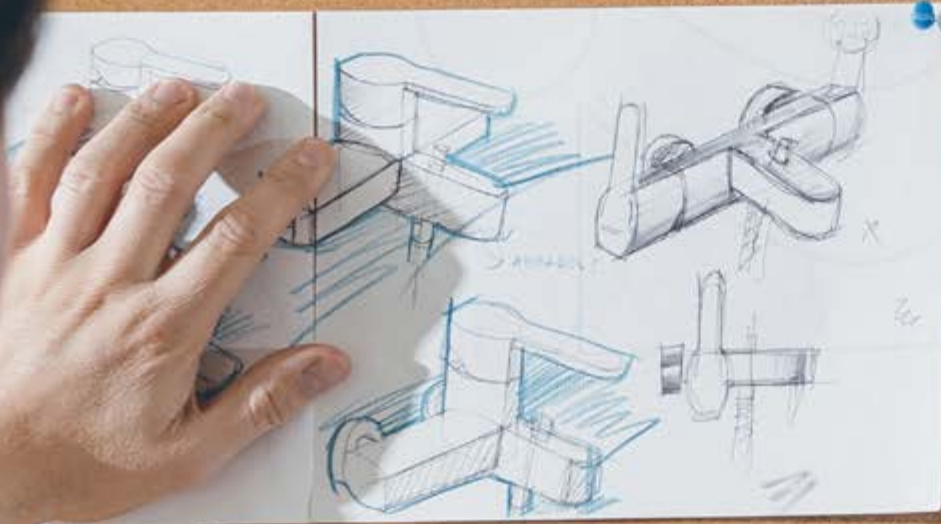

Responsável por produzir uma linguagem visual distinta e apelativa, o **design** está presente desde a génese da **Sanindusa**. Compreende todo um processo criativo exprimindo a visão dos seus criadores e espelhando o posicionamento da empresa. Não se detém apenas na estética das peças, antes agrega aos atributos visuais os funcionais, tornando a interação tanto bela quanto prática e natural.

As peças são concebidas numa **simbiose perfeita entre cores, materiais e formas**, permitindo a interpretação fluída dos elementos e elevando ao expoente máximo a experiência única de utilização.

Assim o retorno é obtido e a distinção é conseguida através do **reconhecimento e prémios conquistados**.

Responsible for producing a distinctive and appealing visual language **Sanindusa's design** element has been present since its genesis. It comprises the whole creative process which expresses the vision of its creators and mirrors the company's positioning. It does not stop in the piece's aesthetic, instead it gathers the visual attributes with the functional ones, making interaction both as beautiful as practical and natural.

The pieces are conceived in a **perfect symbiosis of colours, materials and shapes** which allow a fluid interpretation of the elements and elevates the user experience.

By following their core elements the company has achieved ongoing **brand recognition, awards and return**.

Responsable de la production d'un langage visuel distinctif et attrayant, le **design** est présent depuis la genèse de **Sanindusa**. Elle comprend tout un processus de création exprimant la vision de ses créateurs et reflétant le positionnement de l'entreprise. Elle ne s'arrête pas seulement à l'esthétique des pièces, mais ajoute aux attributs visuels les attributs fonctionnels, rendant l'interaction à la fois belle, pratique et naturelle.

Les pièces sont conçues dans une **symbiose parfaite entre les couleurs, les matériaux et les formes**, permettant une interprétation fluide des éléments et élevant au maximum l'expérience unique d'utilisation.

Ainsi, retour et distinction sont obtenus par la **reconnaissance et les récompenses**.

Responsable de producir un lenguaje visual distintivo y atractivo, el **diseño** ha estado presente desde la génesis de **Sanindusa**. Comprende todo un proceso creativo que expresa la visión de sus diseñadores y se refleja en el posicionamiento de la empresa. No se detiene sólo en la estética de las piezas, sino que añade a los atributos estéticos los funcionales, haciendo la interacción tanto bella como práctica y natural.

Las piezas están concebidas en una perfecta **simbiosis entre colores, materiales y formas**, permitiendo la interpretación fluída de los elementos y elevando al máximo exponente la experiencia única de uso.

De esta manera se obtiene el retorno y la distinción se logra a través de **reconocimientos y premios**.

DESIGN PLUS



“innovation and contribute for our unique creations”

“inovação e oferta de criações únicas”

“innovation et offrent des créations uniques”

“innovación y ofrecen creaciones únicas”

A **Sanindusa** explora o mundo infindável das **cores e texturas** em busca de um design único, dinâmico e arrojado. Os elementos texturados conferem movimento e as tonalidades dourada, cobre, rainbow, entre outras, adicionam um toque refrescante e atribuem personalidade a cada peça.

Energia, confiança, pureza e outras tantas emoções são sentidas na utilização equilibrada dos diferentes matizes. São como mensagens subliminares que comunicam e influenciam o nosso estado de espírito. As cores e texturas retratam a constante procura pela **inovação e oferta de criações únicas**.

Sanindusa explores the endless world of **colours and textures** in search of unique, dynamic and bold designs. The textured elements give movement and combined with the golden, copper and rainbow tones, among others add a refreshing touch and personality to each piece.

The balanced application of different shades emits **energy, confidence, purity and many other emotions**. They are like subliminal messages that communicate and influence our state of mind. The colours and textures portray the constant search for **innovation and contribute for the company's unique creations**.

Au sein de **Sanindusa**, nous explorons le monde infini des **couleurs et des textures** à la recherche d'un design unique, dynamique et audacieux. Les éléments texturés donnent du mouvement et les tons dorés, cuivrés et arc-en-ciel, entre autres, ajoutent une touche de fraîcheur et donnent de la personnalité à chaque pièce.

L'énergie, la confiance, la pureté et bien d'autres émotions sont ressenties dans l'utilisation équilibrée des différentes nuances. Ils sont comme des messages subliminaux qui communiquent et influencent notre état d'esprit.

Les couleurs et les textures traduisent la recherche constante **d'innovation et offrent des créations uniques**.

En **Sanindusa** exploramos el interminable mundo de **colores y texturas** en busca de un diseño único, dinámico y audaz. Los elementos texturizados dan movimiento y los tonos dorados, cobrizos, rainbow, entre otros, añaden un toque refrescante y dan personalidad a cada pieza.

La energía, la confianza, la pureza y muchas otras emociones se sienten en el uso equilibrado de los diferentes tonos. Son como mensajes subliminales que comunican e influyen en nuestro estado mental.

Los colores y texturas representan la constante búsqueda de **innovación y ofrecen creaciones únicas**.





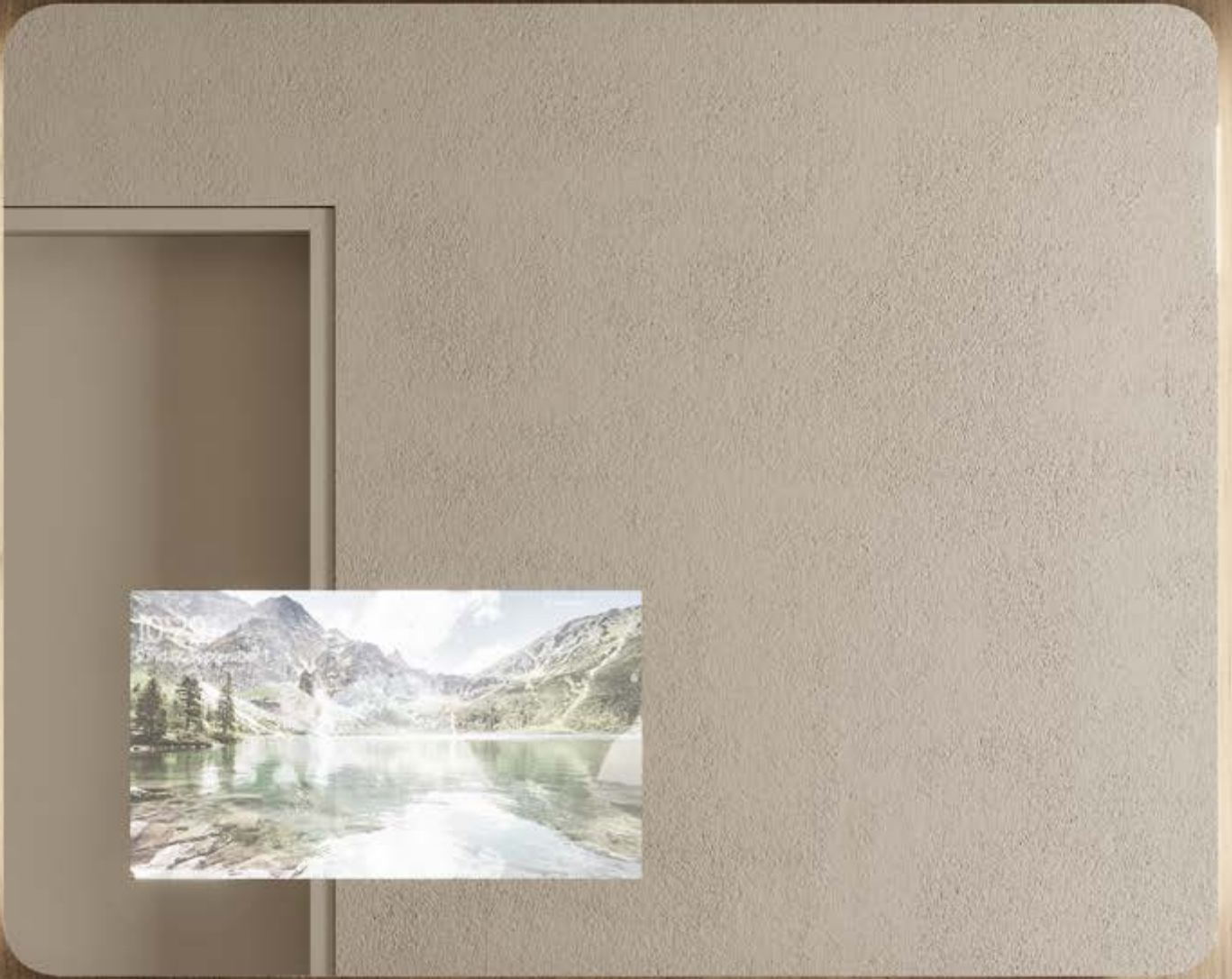

“Technology comes to the bathroom”

“A tecnologia chega à casa de banho”

“La technologie arrive dans la salle de bains”

“La tecnología llega al baño”

A tecnologia chega à casa de banho.

Alguns produtos **Sanindusa** que anteriormente cumpriam funções básicas, são agora equipados com dispositivos inteligentes capazes de proporcionar uma experiência diferenciada com todo o conforto. Esta incorporação tecnológica permite usufruir de funcionalidades que incrementam o **lazer** e a **diversão** durante o tempo passado em frente ao espelho ou a tomar banho.

Technology comes to the bathroom.

Some of **Sanindusa's** products that previously performed basic functions are now equipped with smart devices capable of providing unique and comfortable experiences. This technological incorporation came with functionalities that provide **leisure** and **fun** to the time spent in front of the mirror or in the bath.

La technologie arrive dans la salle de bains.

Chez **Sanindusa**, certains de ses produits qui assuraient auparavant des fonctions de base, sont équipés de dispositifs intelligents capables d'offrir une expérience différenciée en tout confort. Cette incorporation technologique permet de profiter de fonctionnalités qui augmentent le **loisir** et le **plaisir** pendant le temps passé devant le miroir ou prenant un bain.

La tecnología llega al baño.

En **Sanindusa** algunos de sus productos, que anteriormente cumplían funciones básicas, están equipados con dispositivos inteligentes capaces de proporcionar una experiencia diferenciada con toda la comodidad. Esta incorporación tecnológica permite disfrutar de características que aumentan el **ocio** y la **diversión** durante el tiempo que se pasa frente al espejo o tomando un baño.

“continuity of future generations”

“assegurar a continuidade das gerações futuras”

“d’assurer la continuité des générations futures”

“asegurar la continuidad (...) para las generaciones futuras”

A **Sanindusa** produz **produtos sustentáveis** em benefício do **ambiente** como forma de incentivar as boas práticas. A pensar nos recursos naturais a marca tanto oferece uma gama de soluções que elimina ou reduz o consumo de água como apresenta conceitos que incluem funcionalidades ecológicas tais como **Ecospot** e **Coldopen**.

Construir um presente consciente procurando minimizar ou reverter os impactos ambientais de forma a **assegurar a continuidade das gerações futuras** é uma preocupação constante e um dos pilares da **Sanindusa**.

Sanindusa produces **sustainable products** to benefit the environment and as a way to encourage good practices. With natural resources in mind the brand offers both a range of solutions that eliminates or reduces water consumption as well as presents concepts that include ecological features like **EcoSpot** and **Coldopen**.

Consciously building its products to minimize or reverse environmental impacts is a constant concern and one of the main pillars of **Sanindusa** to ensure the **continuity of future generations**.

Dans l’intérêt de l’environnement, nous fabriquons des **produits écologiques** afin d’encourager les bonnes pratiques. En tenant compte des ressources naturelles, la marque propose à la fois une gamme de solutions qui éliminent ou réduisent la consommation d’eau et présente des concepts qui incluent des caractéristiques écologiques telles que l’**Ecospot** et le **Coldopen**.

Construire en cherchant à minimiser ou à inverser les impacts environnementaux afin **d’assurer la continuité des générations futures** est une préoccupation constante et un des piliers de **Sanindusa**.

Para proteger el **medio ambiente** fabricamos **productos sostenibles** como forma de fomentar las buenas prácticas. Teniendo en cuenta los recursos naturales, la marca ofrece una gama de soluciones que eliminan o reducen el consumo de agua y presenta a sus creaciones conceptos que incluyen características ecológicas como el **Ecospot** y **Coldopen**.

El objetivo es minimizar o reverter los impactos ambientales para **asegurar la continuidad** de los recursos naturales **para las generaciones futuras**. Es una preocupación constante y uno de los pilares de **Sanindusa**.



Índice
Index
Index
Índice



LOUÇA SANITÁRIA
SANITARY WARE
APPAREILS SANITAIRES
SANITARIOS

- 20 WCA
- 24 Sanlife
- 30 Status
- 34 Sanibold
- 42 Advance
- 46 Vintage
- 50 Urb.Y Plus
- 54 Sanproject
- 58 Urb.Y
- 66 Look
- 72 Winner
- 76 Easy
- 80 Aveiro
- 84 Cetus

- 89 **Sistemas de instalação**
Installation systems
Systèmes d'installation
Sistemas de intalación



LAVATÓRIOS
BASINS
VASQUES
LAVABOS

- 108 **Encastrar por baixo**
Undermount
À encastrer par dessous
Bajo encimera
- 112 **Encastrar por cima**
Inset
À encastrer par dessus
Encimera
- 120 **Pousar**
Vessel
À poser
Sobre encimera
- 144 **Semi-encastrar**
Semi recessed
Semi-encastrés
Semientpotrar
- 150 **Parede**
Wall mounted
Mural
Mural



MÓVEIS
FURNITURE
MEUBLES
MUEBLES

- 174 **Coleções**
Collections
Collections
Colecciones
- 217 **Espelhos**
Mirrors
Miroirs
Espejos



PEÇAS ESPECIAIS
SPECIAL PIECES
PIÈCES SPÉCIALES
PIEZAS ESPECIALES

- 220 **Urínóis**
Urinals
Urinoirs
Urinarios
- 226 **Separadores**
Dividers
Séparateurs
Separadores
- 227 **Sanita turca**
Squat toilet
Wc turc
Placa turca
- 227 **Pia hospitalar**
Slop hopper
Vidoir d'hôpital
Vertedero
- 228 **Lava-roupas**
Laundry sinks
Bacs à laver
Lavaderos



MOBILIDADE REDUZIDA
REDUCED MOBILITY
MOBILITÉ RÉDUITE
MOVILIDAD REDUCIDA

- 232 **Louça sanitária**
Sanitary ware
Appareils sanitaires
Sanitarios
- 236 **Acessórios**
Accessories
Accessoires
Accesorios
- 243 **Base de duche**
Shower tray
Receveur de douche
Plato de ducha
- 244 **Misturadoras**
Mixers
Robinets
Grifos



INFANTIL
KIDS
ENFANTS
NIÑOS



254

BANHEIRAS
BATHTUBS
BAIGNOIRES
BAÑERAS

256 **Coleções**
Collections
Collections
Colecciones

276 **Acessórios**
Accessories
Accessoires
Accesorios

277 **Bathmoments**

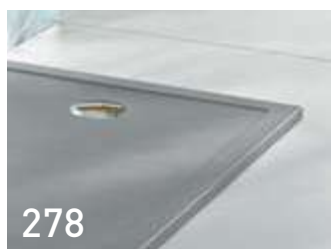

278

BASES DE DUCHE
SHOWER TRAYS
RECEVEURS DE DOUCHE
PLATOS DE DUCHA

280 **Stonit**

288 **Cerâmicas**
Ceramic
Céramiques
Cerámicos

300 **Acrílicas**
Acrylic
Acryliques
Acrílicos

322 **Calha de duche**
Shower channel
Caniveaux de douche
Canal de ducha



324

COLUNAS DE HIDROMASSAGEM
HYDROMASSAGE COLUMNS
COLONNES D'HYDROMASSAGE
COLUMNAS DE HYDROMASAJE



328

DIVISÓRIAS
SHOWER SCREENS
PAROIS
MAMPARAS

330 **Banheiras**
Bathtubs
Baignoires
Bañeras

334 **Bases de duche**
Shower trays
Receveurs de douche
Platos de ducha



344

MISTURADORAS DE WC
BATHROOM MIXERS
ROBINETS DE SALLE DE BAINS
GRIFOS DE BAÑO

352 **Coleções**
Collections
Collections
Colecciones

413 **Torneiras temporizadas**
Timed taps
Robinets temporisée
Grifos temporizados

421 **Torneiras eletrónicas**
Electronic taps
Robinets électroniques
Grifos eletrónicos

435 **Torneira de coluna**
Pillar tap
Robinets simple
Grifo

436 **Acessórios para lavatórios**
Basins accessories
Accessoires pour lavabos
Accesorios para lavabos

437 **Soluções para duche**
Shower solutions
Solutions de douche
Soluciones de ducha



462

ACESSÓRIOS
ACCESSORIES
ACCESSOIRES
ACCESORIOS

464 **Cerâmica**
Ceramic
Céramique
Cerámica

466 **Inox**
Stainless steel
Acier Inoxydable
Acero Inoxidable

468 **Latão**
Brass
Laiton
Latón

474 **Hotelaria**
For hotels
Pour hotellerie
Para hoteles



478

COZINHA
KITCHEN
CUISINE
COCINA

480 **Lava-louças**
Kitchen sinks
Éviers
Fregaderos

493 **Misturadoras**
Mixers
Robinets
Grifos



LOUÇA SANITÁRIA
SANITARY WARE
APPAREILS SANITAIRES
SANITARIOS



Coleções

Collections

Collections

Colecciones

- 20 WCA
- 24 Sanlife NEW
- 30 Status
- 34 Sanibold NEW
- 42 Advance
- 46 Vintage
- 50 Urb.Y Plus NEW
- 54 Sanproject
- 58 Urb.Y NEW
- 66 Look NEW
- 72 Winner NEW
- 76 Easy NEW
- 80 Aveiro
- 84 Cetus NEW

Sistemas de instalação

Installation systems

Systèmes d'installation

Sistemas de intalación

- 90 Estruturas para lavatórios
 Frames for basins
 Bâti-supports pour lavabos
 Soportes para lavabos
- 91 Tanques, estruturas e suportes para sanitas
 Cisterns, supports and frames for toilets
 Réservoirs et bâti-supports pour cuvettes
 Cisternas y soportes para inodoros
- 102 Suportes interiores para bidés suspensos
 Built-in frames for wall mounted bidets
 Bâti-support pour bidets suspendu
 Estructuras internas para bidés suspendidos
- 104 Placas de descarga
 Flush plates
 Plaques de commande
 Placas de accionamiento

Sistemas de dupla descarga

Dual flush systems

Systèmes de double chasse

Sistemas de doble descarga



Os **sistemas de dupla descarga** permitem a **poupança de água**. Os tanques Sanindusa estão equipados com mecanismos que possibilitam descargas de **3/6L** ou **4.5/3L**.

Na prática, permitem selecionar a quantidade de água utilizada em cada descarga, evitando o gasto desnecessário deste recurso cada vez mais escasso. Esta é uma forma racional e confortável de proteger o ambiente.

Dual flush systems are great for **water savings**. Sanindusa's cisterns are equipped with **3/6L** or **4.5/3L** flush mechanisms.

In practice, the user can choose the amount of water used in each flush, avoiding the unnecessary waste of this increasingly scarce resource. This is a rational and comfortable way to protect the environment.

Les **systèmes de double chasse** permettent de réaliser des **économies d'eau**. Nos réservoirs sont équipés de mécanismes qui permettent des décharges de **3/6L** ou **4.5/3L**.

Ceci permet de sélectionner la quantité d'eau utilisée dans chaque décharge, évitant ainsi les dépenses inutiles de cette ressource de plus en plus rare. C'est une façon rationnelle et confortable de protéger l'environnement.

Los **sistemas de doble descarga** permiten el **ahorro de agua**. Nuestros tanques están equipados con mecanismos que permiten descargas de **3/6L** o **4.5/3L**.

En la práctica, permiten seleccionar la cantidad de agua utilizada en cada descarga, evitando el gasto innecesario de este recurso cada vez más escaso. Esta es una forma racional y cómoda de proteger el medio ambiente.



RIMFLUSH



Rimflush

the ultimate hygiene

O sistema de descarga **Rimflush**, caracteriza-se pela distribuição perfeita da água que, através da sua força, efetua uma lavagem perfeita do interior da sanita, sem salpicos. A ausência do aro fechado convencional, permite o acesso facilitado às chamadas zonas difíceis da sanita, garantindo assim uma melhoria significativa ao nível da higiene e maior eficiência da descarga.

Le système de chasse d'eau **Rimflush**, se caractérise par une répartition parfaite de l'eau qui, de par son énergie et sa vitesse, rince efficacement l'intérieur de la cuvette, sans aucune projection. L'absence de la traditionnelle bride facilite l'accès aux zones dites difficiles d'accès de la cuvette, et constitue une amélioration significative en termes d'hygiène.

The **Rimflush** flushing system is characterized by the perfect water distribution which through its power carries out a perfect cleaning of the toilet's interior without splashing. The absence of the conventional closed rim allows easy access to the so-called hard to reach areas of the toilet, ensuring a significant improvement in hygiene and greater discharge efficiency.

El sistema de descarga **Rimflush**, se caracteriza por la distribución uniforme del agua que, a través de su fuerza, efectúa un lavado perfecto y sin salpicaduras del interior del inodoro. La ausencia del marco cerrado convencional permite la limpieza fácil en las zonas difíciles del inodoro, garantizando así una mejora significativa en la higiene y una mayor eficiencia de la descarga.



- Sanlife
- Sanibold
- Sanproject
- Urb.Y
- Look
- Winner
- Easy
- Cetus

Tamos de sanita/bidé
Toilet seats/bidet covers
Abattants pour cuvette/bidet
Tapas de inodoro/bidé



Os tamos da Sanindusa em **Duroplast** oferecem uma **proteção antibacteriana** permanente, graças a uma substância incorporada na matéria-prima que impede o desenvolvimento das bactérias e que dura ao longo de toda a vida útil das peças. Rotinas e práticas de limpeza devem ser mantidas para assegurar a sua eficácia.

Sanindusa's **Duroplast** toilet seats have a permanent **anti-bacterial protection** thanks to a substance that is incorporated into the raw material which prevents the development of bacteria and lasts throughout the lifespan of the pieces. To ensure their effectiveness cleaning practices and routines should not be disregarded.

Les abattants **Duroplast** Sanindusa fournissent une **protection antibactérienne** permanente grâce à une substance qui est incorporée dans la matière première qui empêche le développement de bactéries et ce, pendant toute la durée de vie du produit. L'entretien et le nettoyage doivent être maintenus pour assurer son efficacité.

Las tapas Sanindusa en **Duroplast** proporcionan una **protección antibacteriana** permanente gracias a una sustancia que es incorporada a la materia prima que impide el desarrollo de bacterias y durante toda la vida del producto. Las rutinas y prácticas de limpieza deben mantenerse para garantizar su eficacia.



Tampos de sanita/bidé Toilet seats/bidet covers Abattants pour cuvette/bidet Tapas de inodoro/bidé



SLOWCLOSE

Slowclose é um sistema de queda amortecida que oferece vantagens ao nível da redução do ruído e desgaste dos materiais pela minimização do impacto do assento na sanita ou bidé. Para as crianças, evita ainda acidentes, tornando-se por isso numa solução segura e confortável para o uso diário.

Slowclose is a slow and controlled drop system that offers various benefits. It reduces noise and material wear by minimizing the impact of the seat on the toilet or bidet rim. It also prevents accidents with children. Becoming a safe and comfortable solution for daily use.

Slowclose est un système de chute amortie qui présente l'avantage de réduire le bruit et l'usure des matériaux en minimisant l'impact de l'abattant sur les cuvettes ou le bidet. Pour les enfants, il permet également de prévenir les accidents, devenant ainsi une solution sûre et confortable pour un usage quotidien.

Slowclose es un sistema de caída amortiguada que ofrece ventajas en la reducción del ruido y el desgaste de los materiales al minimizar el impacto de la tapa inodoro en el inodoro o el bidé. En el caso de los niños, también previene los accidentes, convirtiéndose así en una solución segura y cómoda para el uso diario.



EASYCLIP

Os tampos com mecanismo **Easyclip** permitem a colocação e extração imediata do tampo sem recurso a ferramentas. Com um simples movimento vertical é possível a sua libertação rápida, tornando fácil a tarefa de limpeza.

Toilet seats with **Easyclip** mechanism allow the immediate placement and removal of the seat without the use of extra tools. With a quick and easy vertical movement the user can release the seat making the cleaning task easier.

Les abattants à mécanisme **Easyclip** permettent de placer et de retirer immédiatement l'abattant sans utiliser d'outils. Un simple mouvement vertical permet de le libérer rapidement, ce qui facilite la tâche de nettoyage.

Las tapas de los inodoros con mecanismo **Easyclip** permiten la colocación y retirada inmediata sin necesidad de utilizar herramientas. Con un simple movimiento vertical es posible soltarlo rápidamente, facilitando la tarea de limpieza.



CLIPOFF

O sistema **Clipoff** possibilita a remoção e encaixe rápido do tampo. Este vem equipado com dois botões laterais que pressionados permitem retirá-lo sem desapertar quaisquer ferragens. Este facilita a higienização que poderá ser realizada de forma integral, sem esforço.

The **Clipoff** system makes it possible to remove and place the seat or cover quickly from the pottery. It comes equipped with two side buttons that allow its removal without loosening any hinges. This makes the cleaning process easy and effortless.

Le système **Clipoff** permet d'enlever et de mettre en place rapidement l'abattant. Il est équipé de deux boutons latéraux qui permettent de le retirer sans desserrer aucun matériel. Cela facilite le nettoyage hygiénique qui peut être effectué intégralement, sans effort.

El sistema **Clipoff** permite quitar y poner la tapa del inodoro rápidamente. Viene equipado con dos botones laterales que permiten retirarlo sin necesidad de aflojar ningún herraje. Esto facilita la limpieza e higiene integra de la pieza y sin esfuerzo.



DESIGN PLUS



- 1 **sanita compacta** | close coupled toilet | cuvette sur pied | inodoro cisterna baja
- 2 **tanque com dupla descarga** | dual flush cistern | réservoir à double chasse | cisterna de doble descarga
- 3 **bidé** | bidet | bidet | bidé
- 4 **sanita suspensa** | wall mounted toilet | cuvette suspendue | inodoro suspendido
- 5 **bidé suspenso** | wall mounted bidet | bidet suspendu | bidé suspendido
- 6 **lavatório Ø45** | Ø45 basin | vasque Ø45 | lavabo Ø45
- 7 **coluna** | pedestal | colonne | pedestal
- 8 **lavatório 90x54** | 90x54 basin | lavabo 90x54 | lavabo 90x54



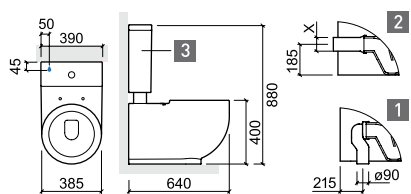

1 111021 3 111111LM 21111
 2 111022

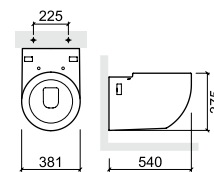

111032 21111

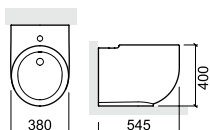

111410

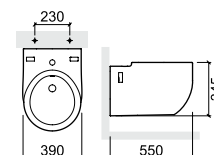

111450

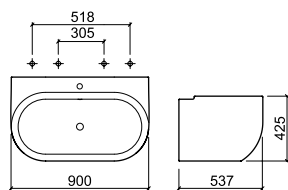

111770

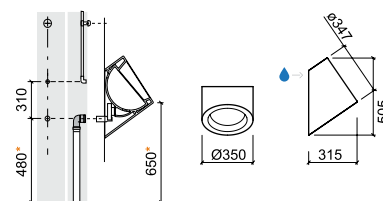

111500

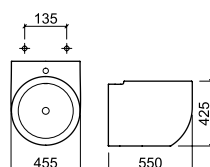

111340

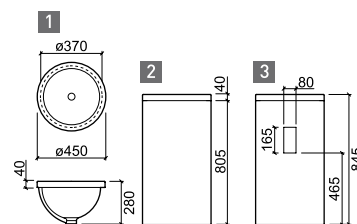

1 111360 2 111200 3 111202



time
is
NOW.



SANLIFE



Rimflush
the ultimate hygiene



ClipOff®



- 1 **sanita compacta** | close coupled toilet | cuvette sur pied | inodoro cisterna baja
- 2 **tanque com dupla descarga** | dual flush cistern | réservoir à double chasse | cisterna de doble descarga
- 3 **bidé** | bidet | bidet | bidé
- 4 **lavatório 60x38** | 60x38 basin | vasque 60x38 | lavabo 60x38
- 5 **lavatório Ø38** | Ø38 basin | vasque Ø38 | lavabo Ø38
- 6 **sanita simples rimflush** | rimflush low level toilet | cuvette simple rimflush | inodoro rimflush cisterna alta

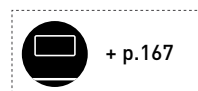
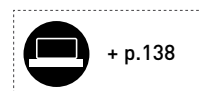

SANLIFE



Cores | Colours | Couleurs | Colores

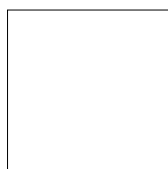

branco
white
blanc
blanco

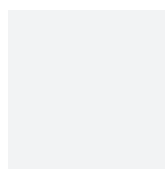

*** branco mate**
matte white
blanc mat
blanco mate



*** taupe mate**
matte taupe
taupe mat
taupe mate

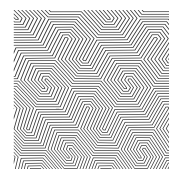

*** branco mate texturado**
textured matte white
blanc mat texturé
blanco mate con textura



Rimflush
the ultimate hygiene



ClipOff®



1 lavatório 40x40 | 40x40 basin | lavabo 40x40 | lavabo 40x40

2 sanita suspensa rimflush | rimflush wall mounted toilet | cuvette suspendue rimflush | inodoro suspendido rimflush

3 bidé suspenso | wall mounted bidet | bidet suspendu | bidé suspendido







SANLIFE

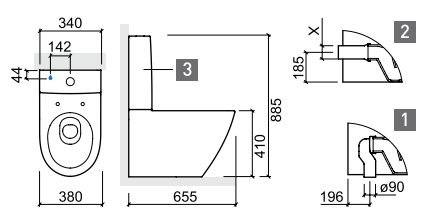

1 136021 3 136111LM 23661 NEW

2 136022

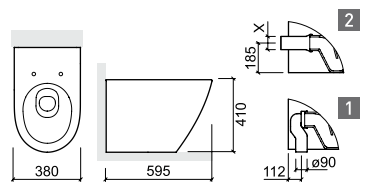

1 136011 23661 NEW

2 136012

Rimflush
the ultimate hygiene

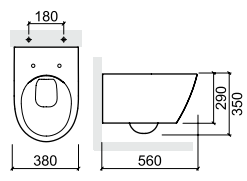

136032 23661 NEW

Rimflush
the ultimate hygiene

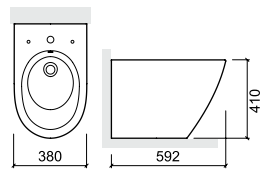

136410
136415 23641

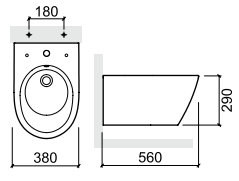

136450
136455 23641

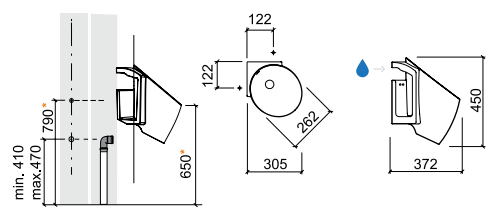

136500

NEW

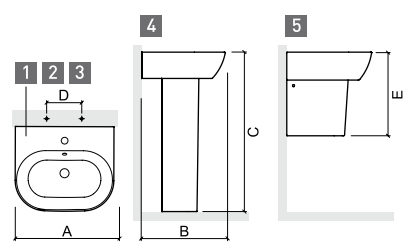

	A	B	C	D	E
1 136300	500	435	850	200	429
2 136310	600	440	860	280	434
3 136320	698	440	855	280	430
4 136200					
5 136220					





STATUS



- 1 sanita compacta** | close coupled toilet | cuvette sur pied | inodoro cisterna baja
- 2 tanque com dupla descarga** | dual flush cistern | réservoir à double chasse | cisterna de doble descarga
- 3 bidé** | bidet| bidet | bidé
- 4 sanita simples** | low level toilet | cuvette simple | inodoro cisterna alta
- 5 lavatório 51x39** | 51x39 basin | lavabo 51x39 | lavabo 51x39
- 6 lavatório 55x34** | 55x34 basin | lavabo 55x34 | lavabo 55x34

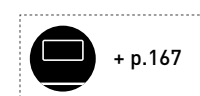
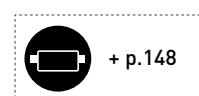



STATUS

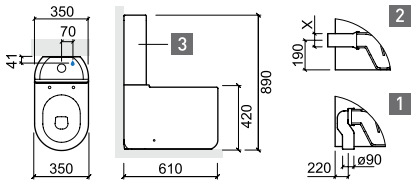

- 1** 123021 **3** 123111LM 22331
- 2** 123022 22311

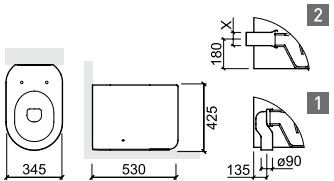

- 1** 123011 22331
- 2** 123012 22311

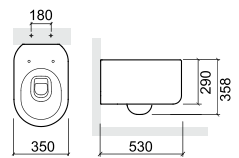

- 123032** 22331
- 22311**

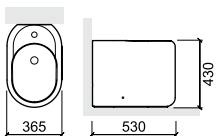

- 123410**

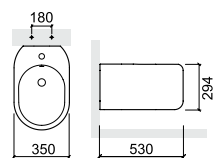

- 123450**





SANIBOLD



- 1 **sanita compacta** | close coupled toilet | cuvette sur pied | inodoro cisterna baja
- 2 **tanque com dupla descarga** | dual flush cistern | réservoir à double chasse | cisterna de doble descarga
- 3 **bidé** | bidet | bidet | bidé
- 4 **lavatório 60x40** | 60x40 basin | vasque 60x40 | lavabo 60x40
- 5 **sanita simples rimflush** | rimflush low level toilet | cuvette simple rimflush | inodoro rimflush cisterna alta



SANIBOLD



Rimflush
the ultimate hygiene



ClipOff®



Cores | Colours | Couleurs | Colores

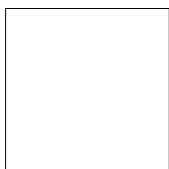

branco
white
blanc
blanco

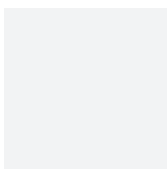

* branco mate
matte white
blanc mat
blanco mate

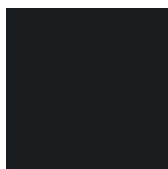

* preto mate
matte black
noir mat
negro mate



- 1 lavatório 48x40 | 48x40 basin | vasque 48x40 | lavabo 48x40
- 2 sanita suspensa | wall mounted toilet | cuvette suspendue | inodoro suspendido
- 3 bidé suspenso | wall mounted bidet | bidet suspendu | bidé suspendido
- 4 sanita suspensa rimflush com fixação oculta | rimflush wall mounted toilet with concealed fixation | cuvette suspendue rimflush avec fixation cachée | inodoro suspendido rimflush con fijación oculta
- 5 bidé suspenso com fixação oculta | wall mounted bidet with concealed fixation | bidet suspendu avec fixation cachée | bidé suspendido con fijación oculta



+ p.137





SANIBOLD

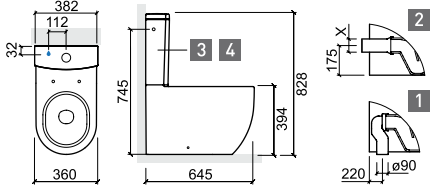

- 1 137021
- 3 137111LM
- 23761 NEW
- 2 137022
- 4 137113LM
- 23731

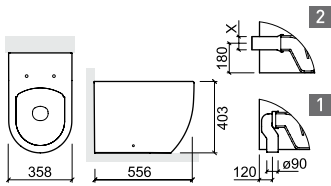

- 1 137011
- 23761 NEW
- 2 137012
- 23731

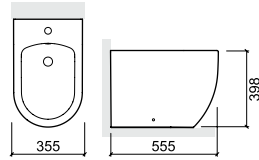

137410

Rimflush
the ultimate hygiene

SANIBOLD

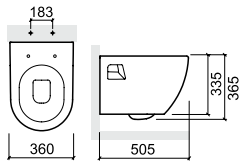

137032 23761 **NEW**

pack
137932
+ 137032
+ 23731

pack
137919
+ 137032
+ 23731
+ 41933
+ 41023

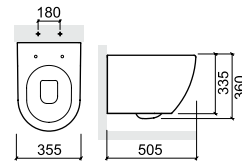

Rim flush

137034 23761 **NEW**

pack
137934
+ 137034
+ 23731

pack
137949
+ 137034
+ 23731
+ 41933
+ 41023

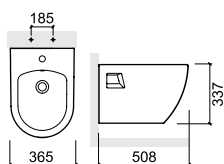

137450

pack
137930
+ 137450
+ 430

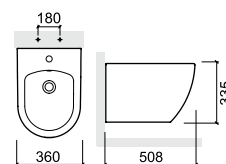

137440

pack
137940
+ 137440
+ 430





ADVANCE

Cores | Colours | Couleurs | Colores

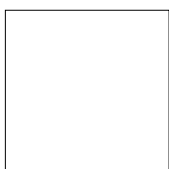

branco
white
blanc
blanco

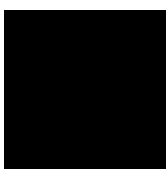

preto
black
noir
negro



- 1 **sanita compacta** | close coupled toilet | cuvette sur pied | inodoro cisterna baja
- 2 **tanque com dupla descarga** | dual flush cistern | réservoir à double chasse | cisterna de doble descarga
- 3 **bidé** | bidet | bidet | bidé
- 4 **sanita simples** | low level toilet | cuvette simple | inodoro cisterna alta
- 5 **lavatório 90x52** | 90x52 basin | lavabo 90x52 | lavabo 90x52
- 6 **lavatório 58x46** | 58x46 basin | vasque 58x46 | lavabo 58x46

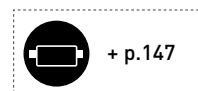





ADVANCE

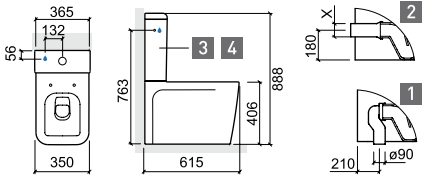

- 1** 127023 **3** 127111LM 22731
- 2** 127024 **4** 127113LM 22711

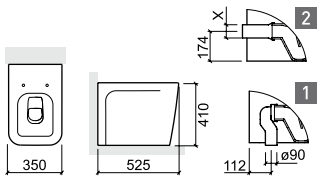

- 1** 127011 22731
- 2** 127012 22711

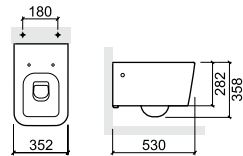

- 127032** 22731
- 22711

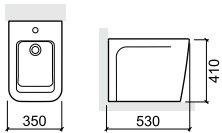

- 127410**
- 127415** 22741

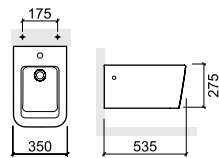

- 127450**

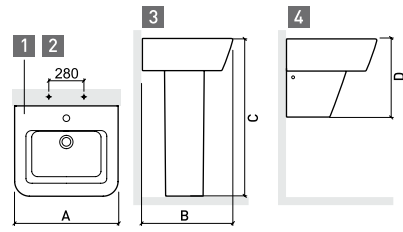

- | | | | | | |
|----------|---------------|-----|-----|-----|-----|
| 1 | 127300 | 550 | 477 | 870 | 418 |
| 2 | 127310 | 650 | 517 | 870 | 415 |
| 3 | 127200 | | | | |
| 4 | 127220 | | | | |

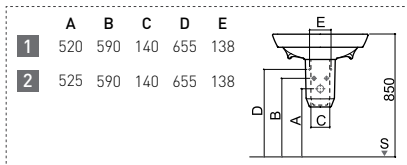



VINTAGE



4 5



6



- 1 **sanita compacta** | close coupled toilet | cuvette sur pied | inodoro cisterna baja
- 2 **tanque com dupla descarga** | dual flush cistern | réservoir à double chasse | cisterna de doble descarga
- 3 **bidé** | bidet | bidet | bidé
- 4 **lavatório 58x46** | 58x46 basin | lavabo 58x46 | lavabo 58x46
- 5 **coluna** | pedestal | colonne | pedestal
- 6 **lavatório 65x50** | 65x50 basin | vasque 65x50 | lavabo 65x50





VINTAGE

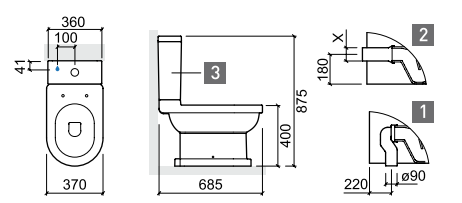

- 1** 117021 **3** 117111LM 21731
- 2** 117022 21711

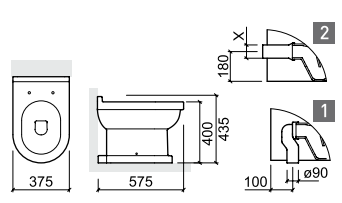

- 1** 117011 21731
- 2** 117012 21711

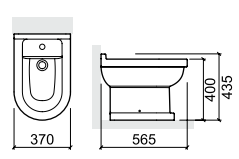

- 117410**
- 117411** ∞∞

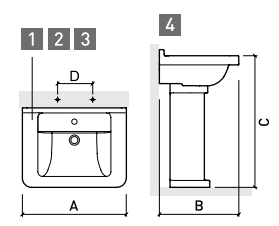

	A	B	C	D
1 117310	580	460	835	260
1 117311	∞∞	580	460	835
2 117320	690	525	865	285
2 117321	∞∞	690	525	865
3 117330	780	555	905	285
3 117331	∞∞	780	555	905
4 117200				





URB.Y PLUS



ClipOff®



Cores | Colours | Couleurs | Colores

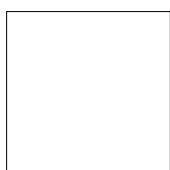

branco
white
blanc
blanco

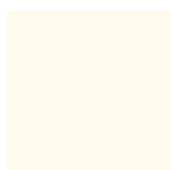

pergamon

- 1 **sanita compacta** | close coupled toilet | cuvette sur pied | inodoro cisterna baja
- 2 **tanque com dupla descarga** | dual flush cistern | réservoir à double chasse | cisterna de doble descarga
- 3 **bidé** | bidet | bidet | bidé
- 4 **lavatório 50x27** | 50x27 basin | vasque 50x27 | lavabo 50x27







URB.Y PLUS

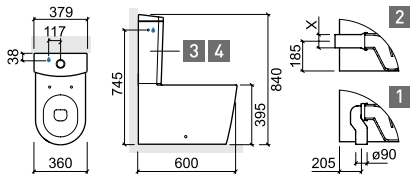

- 1 146021 3 140171LM 24061 NEW
- 2 146022 4 140173LM 24031
- 24011

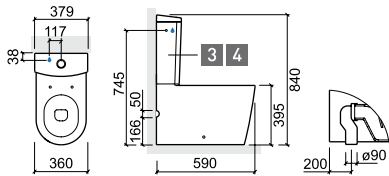

- 146024 3 140171LM 24061 NEW
- 4 140173LM 24031
- 24011

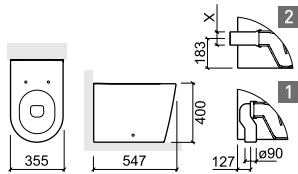

- 1 146011 24061 NEW
- 2 146012 24031
- 24011

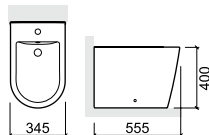

- 146410
- 146415 24041



SANPROJECT



- 1 **sanita simples rimflush** | rimflush low level toilet | cuvette simple rimflush | inodoro rimflush cisterna alta
- 2 **bidé** | bidet | bidet | bidé
- 3 **lavatório 60x52** | 60x52 basin | lavabo 60x52 | lavabo 60x52
- 4 **coluna** | pedestal | colonne | pedestal
- 5 **sanita compacta rimflush** | rimflush close coupled toilet | cuvette sur pied rimflush | inodoro rimflush cisterna baja
- 6 **tanque com dupla descarga** | dual flush cistern | réservoir à double chasse | cisterna de doble descarga





SANPROJECT

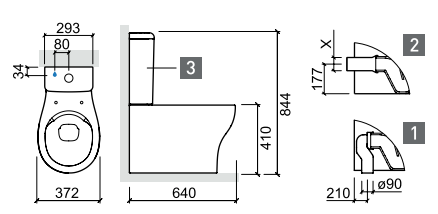

Rimflush
the ultimate hygiene

- 1 139021 3 139111LM 23931 **ClipOff**
- 2 139022

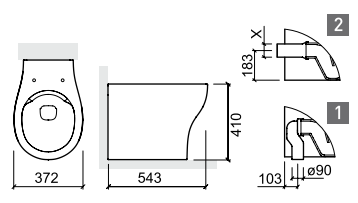

Rimflush
the ultimate hygiene

- 1 139011 23931 **ClipOff**
- 2 139012

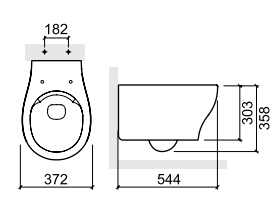

Rimflush
the ultimate hygiene

- 139032 23931 **ClipOff**

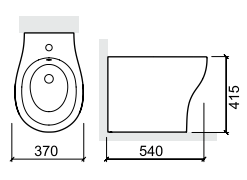

- 139410

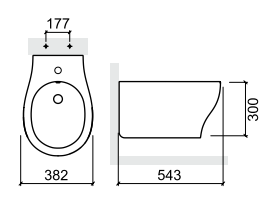

- 139450

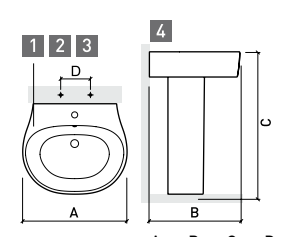

	A	B	C	D
1 139300	504	447	836	190
2 139310	603	517	850	280
3 139320	700	550	-	280
4 139200				





Cores | Colours | Couleurs | Colores

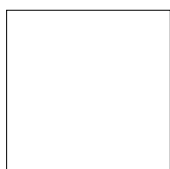

branco
white
blanc
blanco

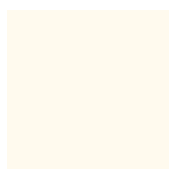

pergamon



Rim flush
the ultimate hygiene



ClipOff®



- 1 **sanita compacta 60cm** | 60cm close coupled toilet | cuvette sur pied 60cm | inodoro cisterna baja 60cm
- 2 **tanque com dupla descarga** | dual flush cistern | réservoir à double chasse | cisterna de doble descarga
- 3 **bidé fechado** | back to wall bidet | bidet compact | bidé compacto
- 4 **sanita compacta 65cm** | 65cm close coupled toilet | cuvette sur pied 65cm | inodoro cisterna baja 65cm
- 5 **bidé** | bidet | bidet | bidé
- 6 **lavatório 54x46** | 54x46 basin | vasque 54x46 | lavabo 54x46

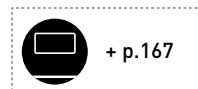
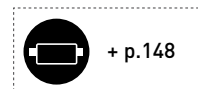



URB.Y

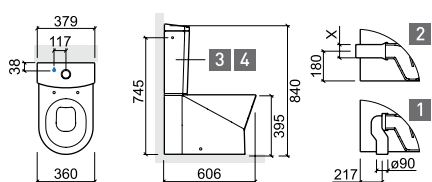

- | | | | |
|-----------------|-------------------|------------------|--|
| 1 140027 | 3 140171LM | 24061 NEW | |
| 2 140028 | 4 140173LM | 24031 | |
| | | 24011 | |

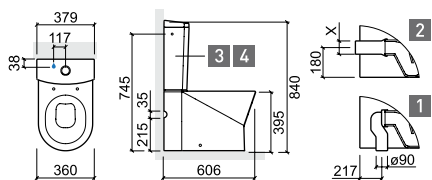

- | | | | |
|-----------------|-------------------|------------------|--|
| 1 140023 | 3 140171LM | 24061 NEW | |
| 2 140024 | 4 140173LM | 24031 | |
| | | 24011 | |

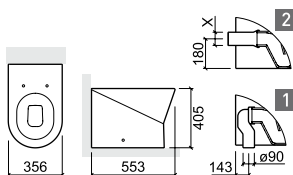

- | | | |
|-----------------|------------------|--|
| 1 140013 | 24061 NEW | |
| 2 140014 | 24031 | |
| | 24011 | |

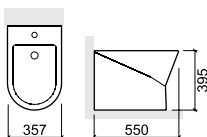

- | | |
|---------------|--------------|
| 140420 | |
| 140425 | 24041 |





URB.Y



140042 24061 **NEW** **easy clip**
 24031 **ClipOff**
 24011 **ClipOff**

NF **140032** 24061 **NEW** **easy clip**
 24031 **ClipOff**
 24011 **ClipOff**

Rimflush **140044** 24061 **NEW** **easy clip**
 24031 **ClipOff**
 24011 **ClipOff**

NEW **Rimflush** **140034** 24061 **NEW** **easy clip**
 24031 **ClipOff**
 24011 **ClipOff**

140440

140450





LOOK



Cores | Colours | Couleurs | Colores



- 1 **sanita compacta** | close coupled toilet | cuvette sur pied | inodoro cisterna baja
- 2 **tanque com dupla descarga** | dual flush cistern | réservoir à double chasse | cisterna de doble descarga
- 3 **bidé** | bidet | bidet | bidé
- 4 **lavatório 60x45** | 60x45 basin | lavabo 60x45 | lavabo 60x45
- 5 **coluna** | pedestal | colonne | pedestal
- 6 **sanita suspensa rimflush** | rimflush wall mounted toilet | cuvette suspendue rimflush | inodoro rimflush suspendido
- 7 **bidé suspenso** | wall mounted bidet | bidet suspendu | bidé suspendido

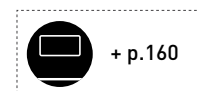
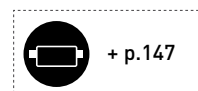





LOOK

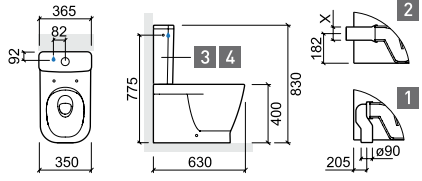

Rimflush
The ultimate hygiene

- | | | | | | | | |
|-----------------|-------------------|-------|--|--|--|--|--|
| 1 134023 | 3 134111LM | 23461 | | | | | |
| 2 134024 | 4 134113LM | 23431 | | | | | |
| | | 23411 | | | | | |

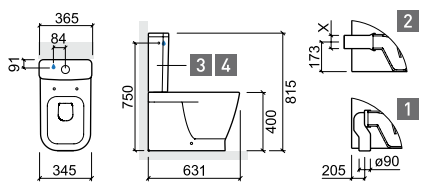

- | | | | | | | | |
|-----------------|-------------------|-------|--|--|--|--|--|
| 1 134021 | 3 134111LM | 23461 | | | | | |
| 2 134022 | 4 134113LM | 23431 | | | | | |
| | | 23411 | | | | | |

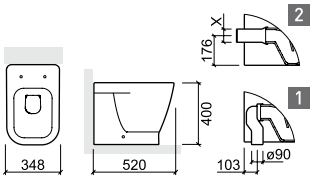

- | | | | | | | |
|-----------------|-------|--|--|--|--|--|
| 1 134011 | 23461 | | | | | |
| 2 134012 | 23431 | | | | | |
| | 23411 | | | | | |

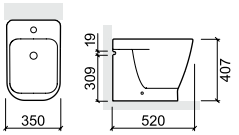

- | | | | | | |
|---------------|--|-------|--|--|--|
| 134420 | | | | | |
| 134425 | | 23441 | | | |

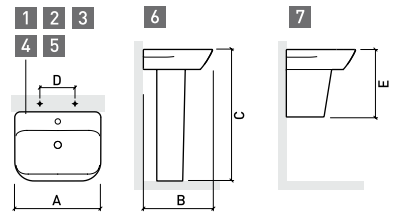

	A	B	C	D	E
1 134310	460	416	850	228	440
2 134320	500	414	850	280	440
3 134330	560	449	850	280	440
4 134340	600	449	850	280	440
5 134370	660	443	850	278	444
6 134200					
7 134220					

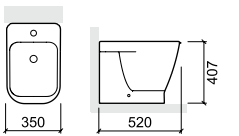

- | | | | | | |
|---------------|--|-------|--|--|--|
| 134410 | | | | | |
| 134415 | | 23441 | | | |

	A	B	C	D	E
1	576	618	140	680	118
2	561	630	140	680	118
3	558	623	140	673	118
4	560	625	140	675	118
5	555	625	140	675	118

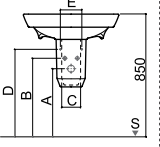

LOOK



134032 **23461**
23431
23411

134034 **23461**
23431
23411

134450
134455 **23441**

134440
134445 **23441**





WINNER



NEW



Rimflush
The ultimate hygiene



easy clip
SYSTEM

1 2 3



- 1 **sanita compacta rimflush** | rimflush close coupled toilet | cuvette sur pied rimflush | inodoro rimflush cisterna baja
- 2 **tanque com dupla descarga** | dual flush cistern | réservoir à double chasse | cisterna de doble descarga
- 3 **bidé** | bidet | bidet | bidé
- 4 **lavatório 55x43** | 55x43 basin | lavabo 55x43 | lavabo 55x43
- 5 **coluna suspensa** | wall hung pedestal | semi-colonne | semi pedestal



WINNER

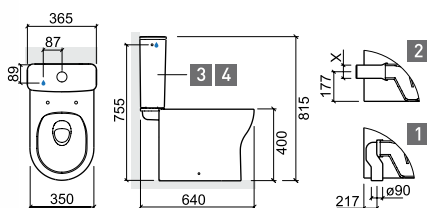

NEW Rim flush
The ultimate hygiene

- 1 142021 3 142111LM 24231
- 2 142022 4 142113LM

easy clip

packs	142921	142923
	+ 142021	+ 142021
	+ 142111LM	+ 142113LM

packs	142922	142924
	+ 142022	+ 142022
	+ 142111LM	+ 142113LM



NEW

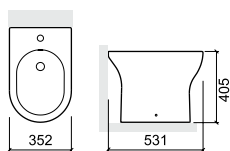

142410



NEW

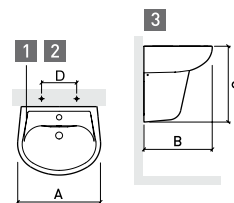

	A	B	C	D
1 142300	559	435	509	265
2 142310	608	458	509	278
3 142220				

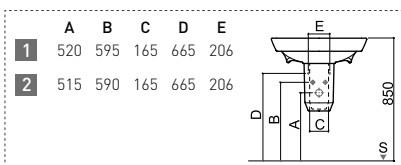

	A	B	C	D	E
1	520	595	165	665	206
2	515	590	165	665	206





EASY

NEW



Rimflush
the ultimate hygiene

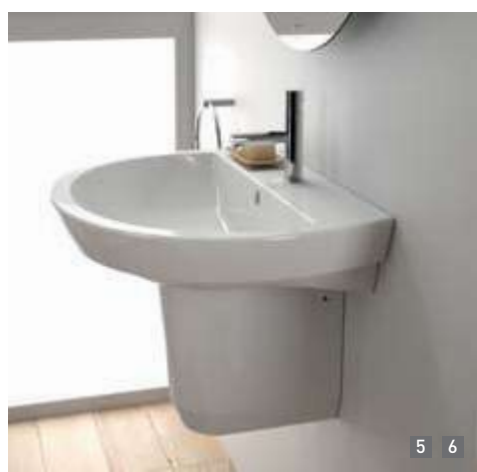

Cores | Colours | Couleurs | Colores

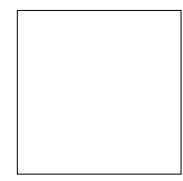

branco
white
blanc
blanco



pergamon

- 1 **sanita compacta rimflush** | rimflush close coupled toilet| cuvette sur pied rimflush | inodoro rimflush cisterna baja
- 2 **tanque com dupla descarga** | dual flush cistern | réservoir à double chasse | cisterna de doble descarga
- 3 **bidé** | bidet | bidet | bidé
- 4 **sanita compacta** | close coupled toilet| cuvette sur pied | inodoro cisterna baja
- 5 **lavatório 55x45** | 55x45 basin | lavabo 55x45 | lavabo 55x45
- 6 **coluna suspensa** | wall hung pedestal | semi-colonne | semi pedestal
- 7 **lavatório 46x38** | 46x38 basin | lavabo 46x38 | lavabo 46x38





EASY

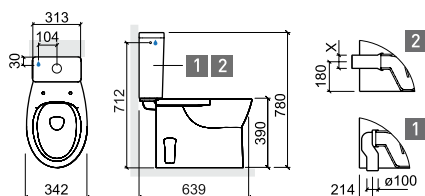

NEW Rimflush
za lepšiu hygienu

- 1** 131023 **3** 131111LM 23131
- NF** **2** 131024 **NF** **4** 131113LM 23114
- 23121

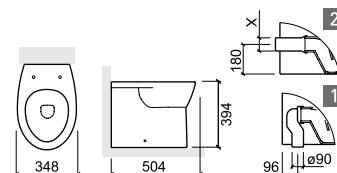

- 1** 131013 23131
- 2** 131014 23114
- 23121

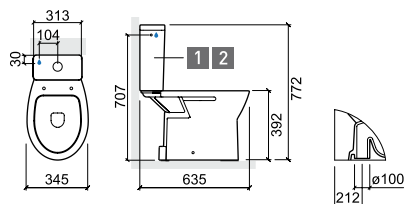

- NF** 131021 **1** 131111LM 23131
- NF** **2** 131113LM 23114
- 23121

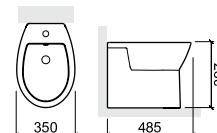

- 131420
- 131425 23141

packs

131925	131927
+ 131021	+ 131021
+ 131111LM	+ 131113LM
+ 23121	+ 23121

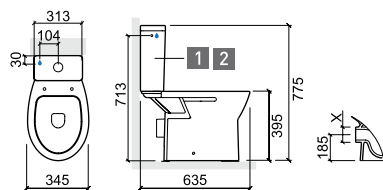

- 131022 **1** 131111LM 23131
- NF** **2** 131113LM 23114
- 23121

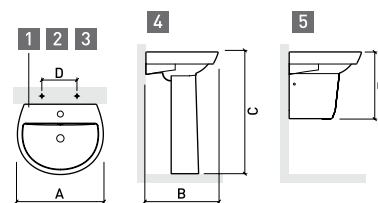

	A	B	C	D	E
1 131330	500	425	845	245	415
2 131310	548	443	846	272	415
NF 3 131320	612	467	845	280	415
NF 4 131200					
5 131220					

packs

131926	131928
+ 131022	+ 131022
+ 131111LM	+ 131113LM
+ 23121	+ 23121

	A	B	C	D	E
1	525	580	140	640	130
2	535	590	140	640	130
3	530	585	140	640	130

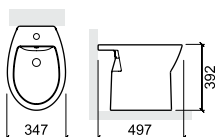

- 131410
- 131415 23141





AVEIRO

Cores | Colours | Couleurs | Colores



branco
white
blanc
blanco

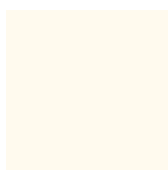

pergamon

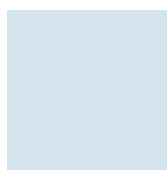

azul
blue
bleu
azul

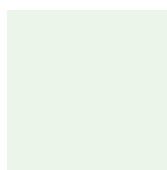

verde
green
vert
verde



almond

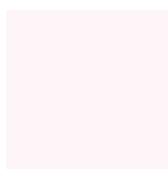

rosa
pink
rose
rosa



cinza
grey
gris
gris



- 1 **sanita compacta** | close coupled toilet | cuvette sur pied | inodoro cisterna baja
- 2 **tanque** | cistern | réservoir | cisterna
- 3 **bidé** | bidet | bidet | bidé
- 4 **lavatório 60x51** | 60x51 basin | lavabo 60x51 | lavabo 60x51
- 5 **coluna** | pedestal | colonne | pedestal
- 6 **sanita suspensa** | wall mounted toilet | cuvette suspendue | inodoro suspendido

AVEIRO

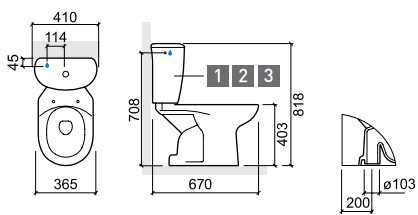

103021

1	103111LM	20331		
2	103113LM	20320		
3	103113PF	20321		

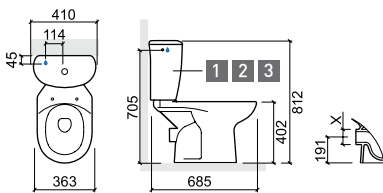

103022

1	103111LM	20331		
2	103113LM	20320		
3	103113PF	20321		

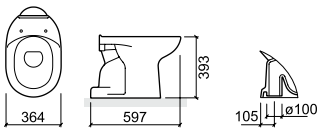

103011

20331		
20320		
20321		

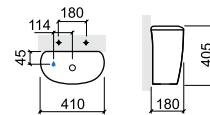

103112

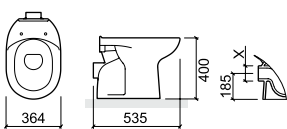

103012

20331		
20320		
20321		

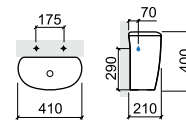

103114



AVEIRO

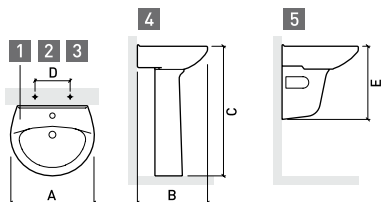

	A	B	C	D	E
1 103300	550	455	820	285	-
2 103310	595	505	820	283	505
3 103320	665	535	835	284	525
4 103200					
5 103220					

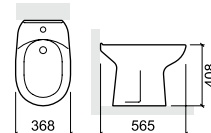
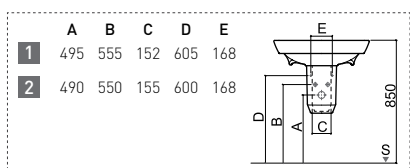

103410 20341

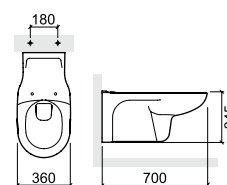

NF 103042

20331

20320

NF 20321





CETUS



Rimflush
the ultimate hygiene



ClipOff®



Cores | Colours | Couleurs | Colores

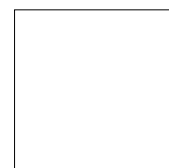

branco
white
blanc
blanco



pergamon

- 1 **sanita suspensa** | wall mounted toilet | cuvette suspendue | inodoro suspendido
- 2 **bidé suspenso** | wall mounted bidet | bidet suspendu | bidé suspendido
- 3 **lavatório 55x43** | 55x43 basin | lavabo 55x43 | lavabo 55x43
- 4 **coluna suspensa** | wall hung pedestal | semi-colonne | semi pedestal





CETUS

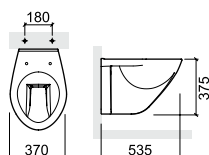

- NF** 110032 21031 21061
 21011 21021
 21051 *

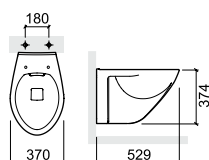

Rim flush
Para ultravioleta higienizante

- 110034 21031 21061
 21011 21021
 21051 *

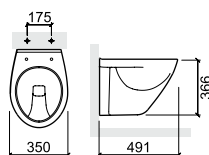

- NF** 110042 21034
 21014

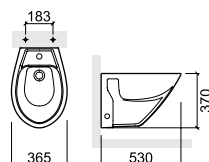

110450

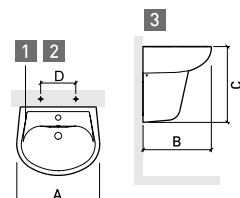

- | | A | B | C | D |
|----------|-----|-----|-----|-----|
| 1 110300 | 559 | 435 | 509 | 265 |
| 2 110310 | 608 | 458 | 509 | 278 |
| 3 110220 | | | | |

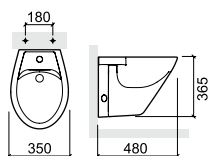

110440

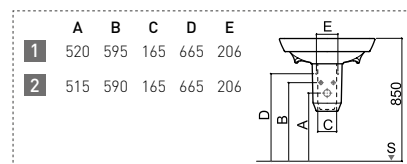

NEW

* disponível apenas em branco | only available in white | disponible seulement en blanc | disponible solo en blanco
 ⚠️ dimensões sujeitas a alterações | dimensions may be subject to change | dimensions susceptibles de modification | dimensiones sujetas a cambios

Sistemas de instalação
Installation systems
Systèmes d'installation
Sistemas de intalación



Estruturas para lavatórios
 Frames for basins
 Bâti-supports pour lavabo
 Soportes para lavabos



LOOK + SANFIX

SANFIX

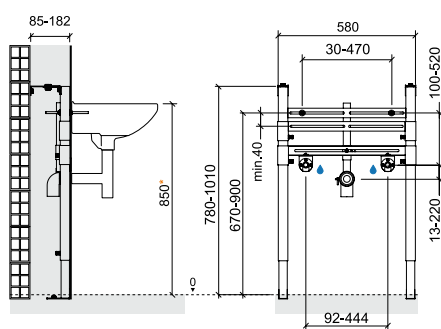

420

150KG

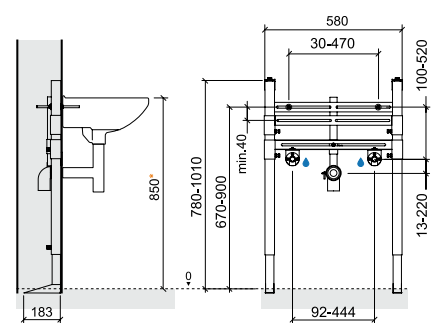

429

150KG



Tanques exteriores para sanitas simples
 External cisterns for low level toilets
 Réservoirs extérieurs pour cuvettes au sol
 Cisternas altas exteriores para inodoros a suelo



EASY + REPLAY

REPLAY

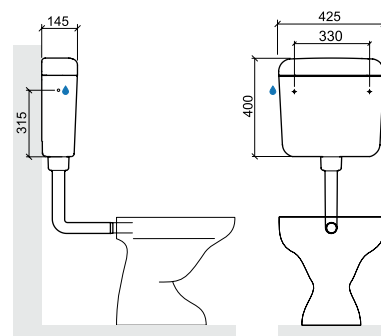

40562



SIMPLE

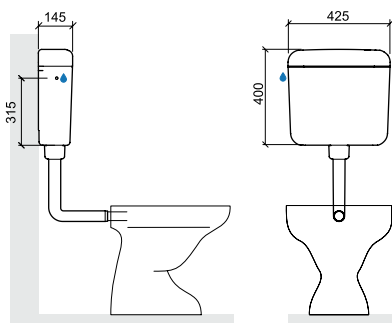

40561



BASIC

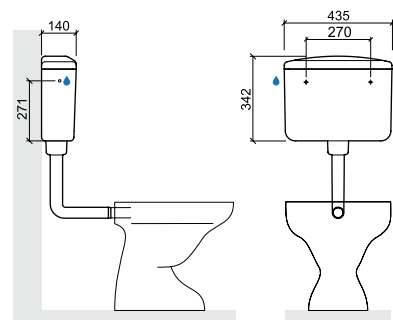

40261



Tanques interiores para sanitas simples
 Interior cisterns for low level toilets
 Réservoirs intérieurs pour cuvettes au sol
 Cisternas altas interiores para inodoros a suelo

QUADRO

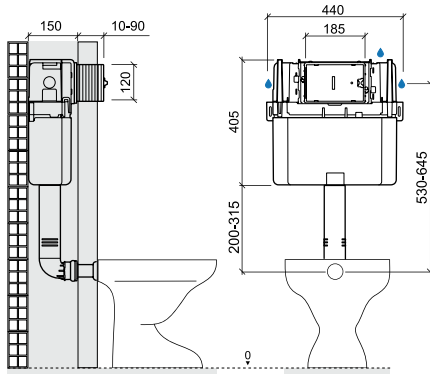

445

WALLFIT

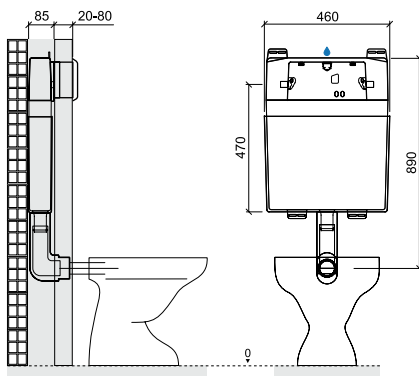

40433

SWITCH

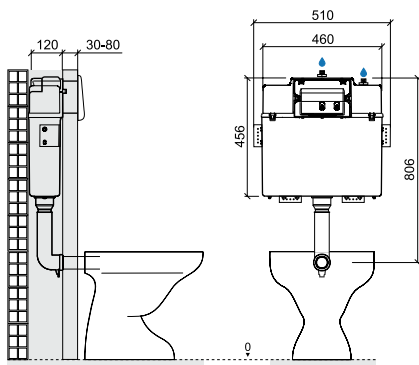

40133



SANLIFE + MOOVE



Estruturas exteriores para sanitas simples
 External frames for low level toilets
 Panneaux WC extérieures pour cuvettes au sol
 Estructuras externas para inodoros a suelo



URB.Y + SANGLOSS

SANGLOSS

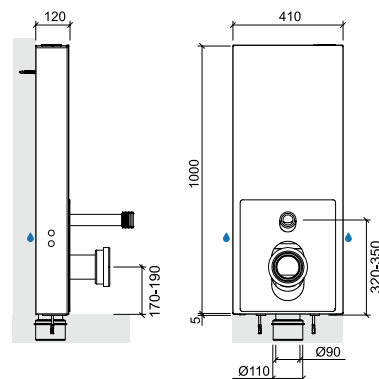

41833



Estructuras exteriores para sanitas suspendidas

External frames for wall mounted toilets

Panneaux WC extérieures pour cuvettes suspendues

Estructuras externas para inodoros suspendidos



SANGLOSS WALL

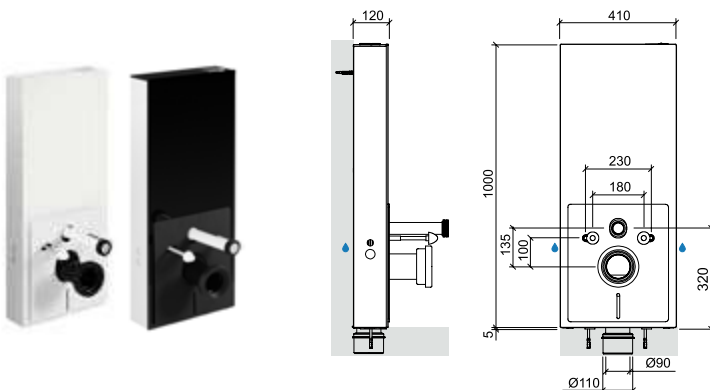

41733

Estrutura interior (sem tanque) para sanitas suspensas
Built-in frame (without cistern) for wall mounted toilets
Bâti-support (sans réservoir) pour cuvettes suspendues
Estructura interna (sin cisterna) para inodoros suspendidos



CETUS + ECO

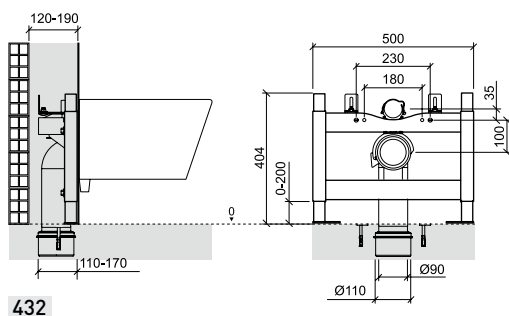

Estruturas interiores para sanitas suspensas
Built-in frames for wall mounted toilets
Bâti-supports pour cuvettes suspendues
Estructuras internas para inodoros suspendidos

QUADRO

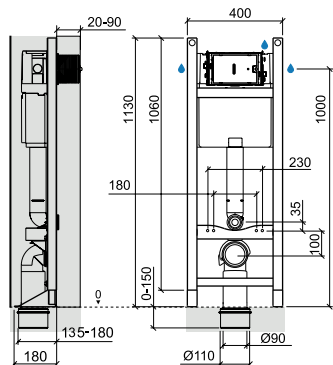

449



SANFIX

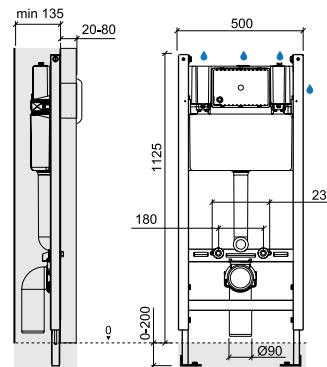

40323



QUADRO

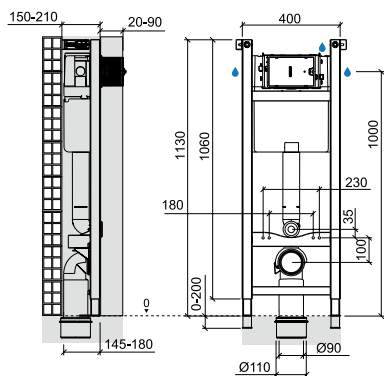

443



SANFIX

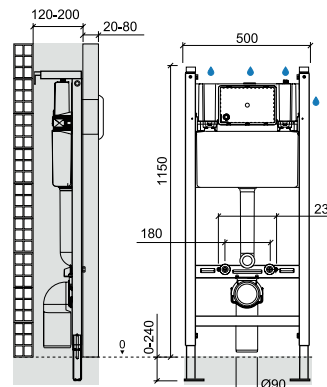

40333



QUADRO

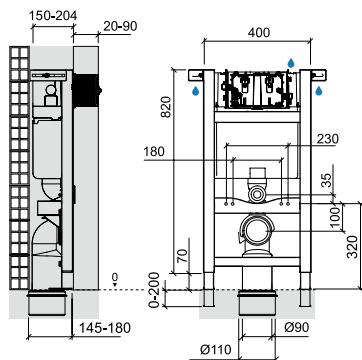

453



SANSPLACE

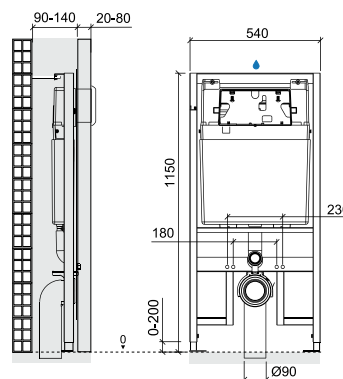

40633







Estructuras interiores para sanitas suspendidas
 Built-in frames for wall mounted toilets
 Bâti-supports pour cuvettes suspendues
 Estructuras internas para inodoros suspendidos

SANDOUBLE

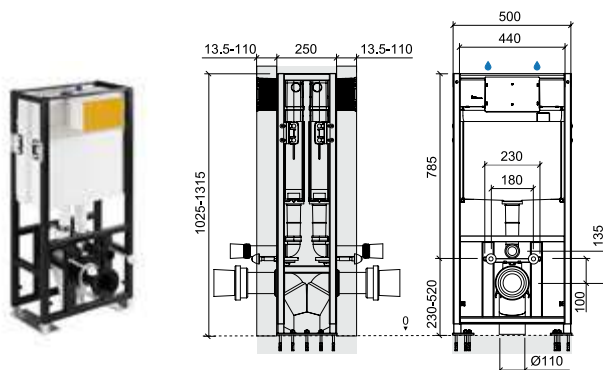

411023

SANBEST

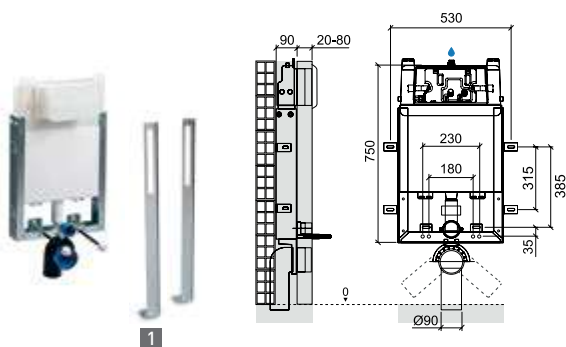

40533 1 4A0233

SANSLIM

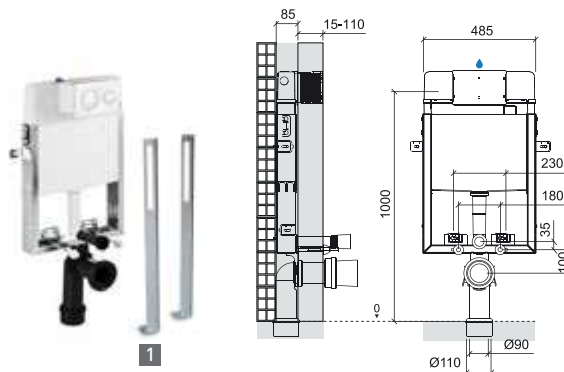

41233 1 4A0233

41933
 + 41233
 + 41023
 pack

SANFLUSH

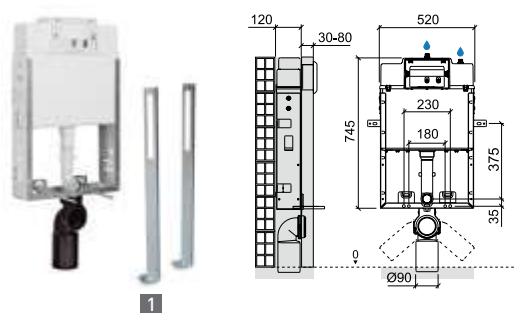

40233 1 4A0233



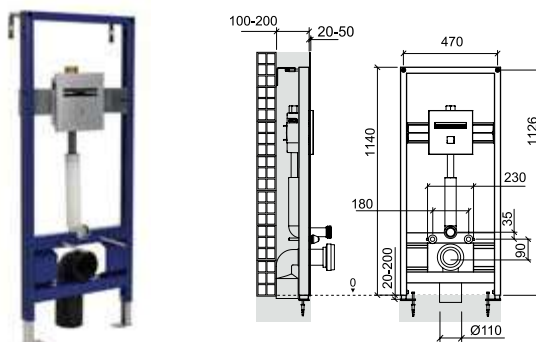



PLAN

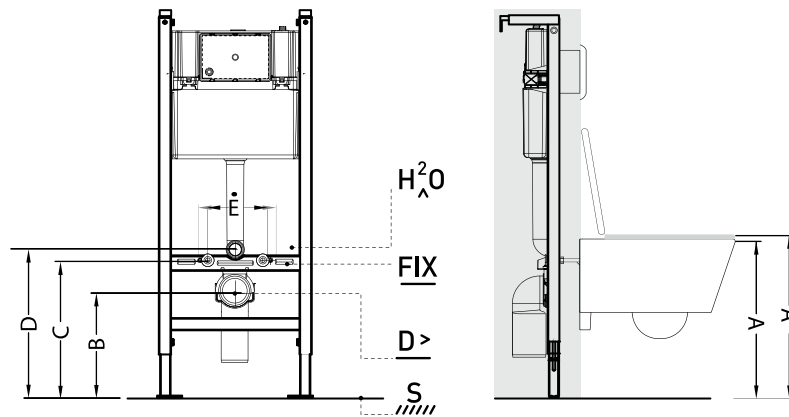

5E12077 5E12078

Cotas de instalação (recomendadas) para sanitas suspensas
 (Recommended) installation dimensions for wall mounted toilets
 Cotes d'installation (recommandée) pour cuvettes suspendues
 Cotas de instalación (recomendadas) para inodoros suspendidos



	A	B	C	D	E
WCA	420	215	315	350	230
SANLIFE 	420	240	339	375	180
STATUS	420	235	333	383	180
SANIBOLD	420	233	333	365	180
SANIBOLD 	420	222	327	360	180
ADVANCE	420	239	339	374	180
SANPROJECT 	420	241	340	374	180
URB.Y 48	420	240	340	375	180
URB.Y 48 	420	230	335	365	180
URB.Y 52	420	240	340	375	180
URB.Y 52 	420	240	335	375	180
LOOK	420	228	332	362	180
LOOK 	420	230	325	361	180
AVEIRO 70	450*	270	370	405	180
CETUS 48	420	235	340	375	180
CETUS 52	420	235	335	370	180
CETUS 52 	420	225	330	360	180
NEW WCCARE	450*	202	302	337	230

FIX
 fixação
 fixation
 fijación





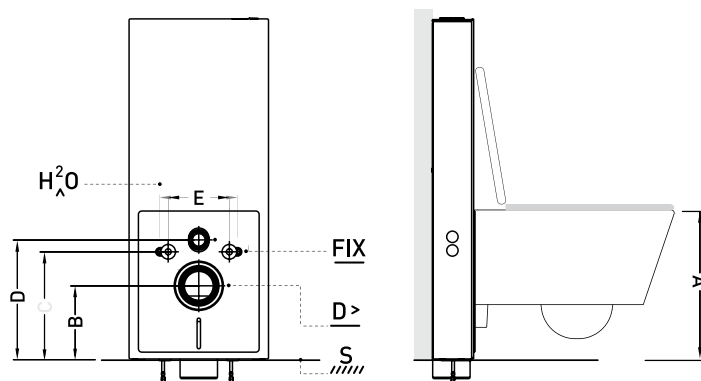

H²O
 entrada de água
 water supply
 alimentation d'eau
 alimentación de agua

D>
 descarga
 flush
 chasse d'eau
 descarga

S
 solo
 finished floor
 sol fini
 suelo

Cotas de instalação (recomendadas) SANGLOSS WALL para sanitas suspensas
SANGLOSS WALL (recommended) installation dimensions for wall mounted toilets
Cotes d'installation (recommandée) SANGLOSS WALL pour cuvettes suspendues
Cotes de instalación (recomendadas) SANGLOSS WALL para inodoros suspendidos



	A	B	C	D	E
WCA	425	220	320	355	230
SANLIFE 	400	220	320	355	180
STATUS	407	222	320	370	180
SANIBOLD	407	220	320	352	180
SANIBOLD 	413	215	320	353	180
ADVANCE	400	219	320	355	180
SANPROJECT 	400	221	320	354	180
URB.Y 48	400	220	320	355	180
URB.Y 48 	405	215	320	350	180
URB.Y 52	400	220	320	355	180
URB.Y 52 	405	225	320	360	180
LOOK	408	216	320	350	180
LOOK 	415	225	320	356	180

FIX
 fixação
 fixation
 fijación

H²O
 entrada de água
 water supply
 alimentation d'eau
 alimentación de agua

D >
 descarga
 flush
 chasse d'eau
 descarga

S
 solo
 finished floor
 sol fini
 suelo

Suportes interiores para bidés suspensos
 Built-in frames for wall mounted bidets
 Bâti-support pour bidets suspendu
 Estructuras internas para bidés suspendidos



SANIBOLD

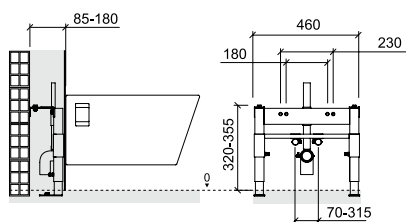



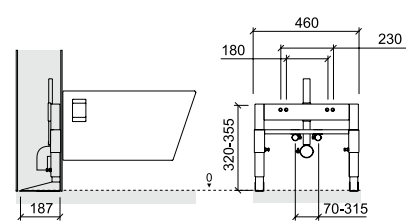



430

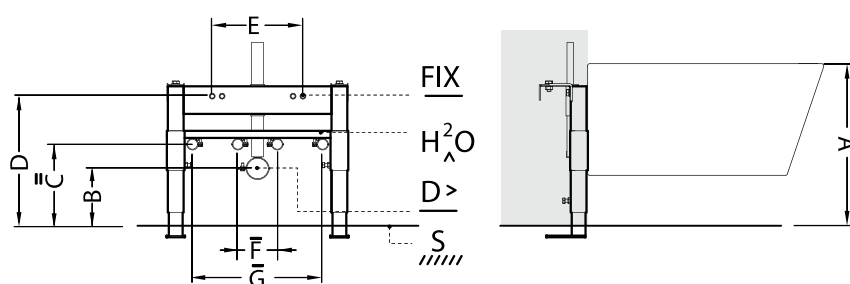

439

Cotas de instalação (recomendadas) para bidés suspensos
 (Recommended) installation dimensions for wall mounted bidets
 Cotes d'installation (recommandée) pour bidets suspendues
 Cotas de instalación (recomendadas) para bidés suspendidos



	A	B	C	D	E	F	G
WCA	420	145	210	320	230	100	-
SANLIFE	420	145	170	345	180	150	300
STATUS	420	110	240	355	180	130	-
SANIBOLD	420	130	130	340	180	130	300
SANIBOLD 	420	140	130	335	180	130	300
ADVANCE	420	194	259	354	180	100	-
SANPROJECT	420	115	145	345	180	145	300
URB.Y 48	420	115	180	340	180	100	300
URB.Y 52	420	115	165	340	180	145	300
LOOK	420	140	140	350	180	120	300
LOOK 	420	130	140	350	180	135	300
CETUS	420	115	180	330	180	100	300
							
							

FIX
 fixação
 fixation
 fijación

H²O
 entrada de água
 water supply
 alimentation d'eau
 alimentación de agua

D>
 descarga
 flush
 chasse d'eau
 descarga

S
 solo
 finished floor
 sol fini
 suelo

Placas de descarga
 Flush plates
 Plaques de commande
 Placas de accionamiento



MOON

SQUARE

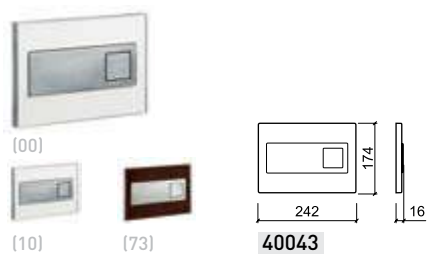

QUADRO

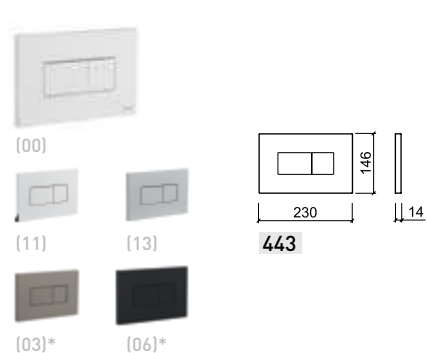

MOON

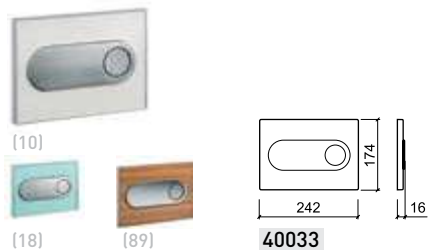



Placas de descarga
 Flush plates
 Plaques de commande
 Placas de accionamiento



ORANGE

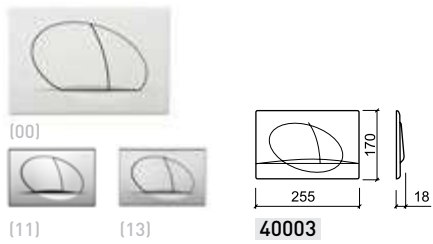

PLAN

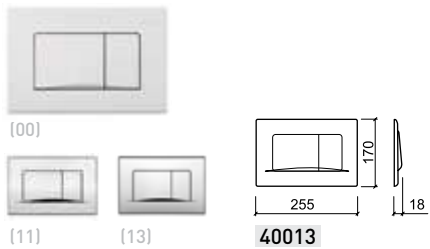

EASY

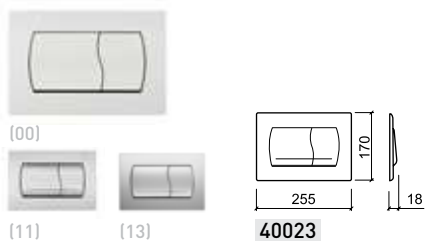

MOOVE

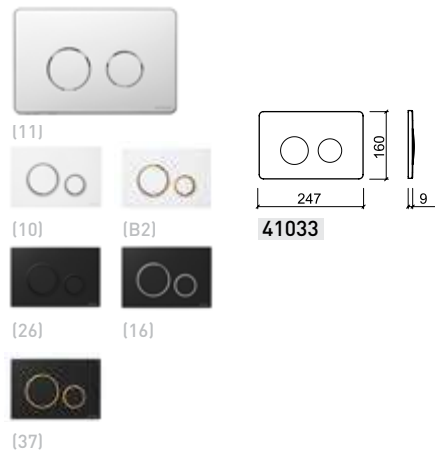

PLAN

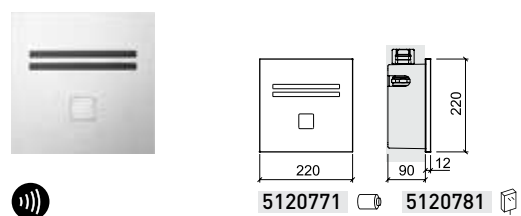





Encastrar por baixo

Undermount

À encastrer par dessous

Bajo encimera

- 111 Agres
- 111 Anna
- 111 Arc
- 111 Biar
- 111 Simple
- 111 Vouga

Encastrar por cima

Inset

À encastrer par dessus

Encimera

- 115 Alicante
- 115 Almoradi
- 115 Anna
- 116 Área
- 116 Área Plus NEW
- 116 Frame
- 116 Millennium
- 116 Paris
- 119 Tabarca
- 119 Tejo
- 119 Vintage
- 119 WCA

Pousar

Vessel

À poser

Sobre encimera

- 125 Advance
- 125 Algar
- 125 Belfast
- 125 Blok
- 125 Comby
- 126 Flow
- 126 Frame
- 126 Hi-dden
- 126 Join
- 126 Look
- 129 Morfys
- 130 Note
- 130 Novelda Plus
- 130 Polop
- 133 Ring
- 134 Round
- 137 Sanibold
- 138 Sanproject
- 138 Sanlife
- 141 Sign
- 142 Status
- 142 Tribo
- 142 Unu
- 142 Vista

Semi-encastrar

Semi recessed

Semi-encastrés

Semiempotrar

- 147 Advance
- 147 Flat
- 147 Linha
- 147 Look
- 148 Palm
- 148 Status
- 148 Urb.Y
- 148 Urb.Y Plus
- 148 Valência

Parede

Wall mounted

Mural

Mural

- 155 Advance
- 155 Blend
- 155 Cetus Basic
- 155 Clean
- 156 Douro
- 156 Easy
- 156 Flow
- 159 Flux
- 160 Look
- 160 Mira
- 160 Mondego
- 163 Note
- 164 Novelda Plus
- 164 Palm
- 164 Plan
- 167 Sado
- 167 Sanlife
- 167 Sanproject
- 167 Status
- 167 Urb.Y
- 168 Vista
- 168 WCA



Encastrar por baixo
Undermount
À encastrer par dessous
Bajo encimera



- 1 lavatório agres 54x34 | 54x34 agres basin | vasque agres 54x34 | lavabo agres 54x34
- 2 lavatório agres 77x35 | 77x35 agres basin | vasque agres 77x35 | lavabo agres 77x35
- 3 lavatório simple 48x39 | 48x39 simple basin | vasque simple 48x39 | lavabo simple 48x39
- 4 lavatório arc Ø46 | Ø46 arc basin | vasque arc Ø46 | lavabo arc Ø46
- 5 lavatório biar 53x39 | 53x39 biar basin | vasque biar 53x39 | lavabo biar 53x39





AGRES *

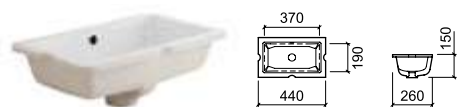

118940

ARC *

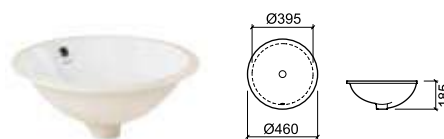

108760

BIAR *

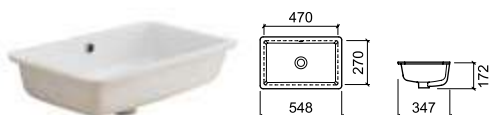

118370

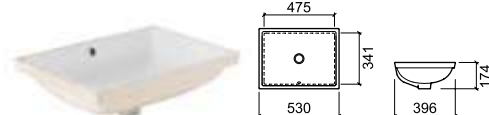

118350

SIMPLE *

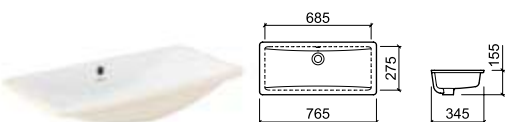

118880

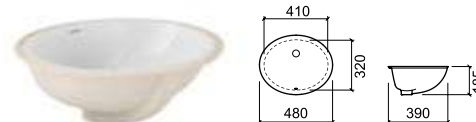

108750

ANNA *

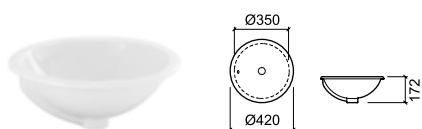

118340

VOUGA *

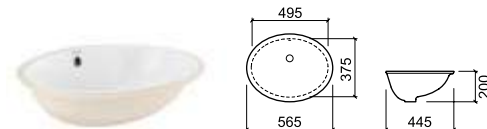

108350





- 1 lavatório paris 55x44 | 55x44 paris basin | vasque paris 55x44 | lavabo paris 55x44
- 2 lavatório almoradi 61x35 | 61x35 almoradi basin | vasque almoradi 61x35 | lavabo almoradi 61x35
- 3 lavatório frame 60x36 | 60x36 frame basin | vasque frame 60x36 | lavabo frame 60x36
- 4 lavatório anna Ø41 | Ø41 anna basin | vasque anna Ø41 | lavabo anna Ø41
- 5 lavatório área plus 81x46 | 81x46 área plus basin | vasque área plus 81x46 | lavabo área plus 81x46



ALICANTE



ALMORADÍ

ALMORADI

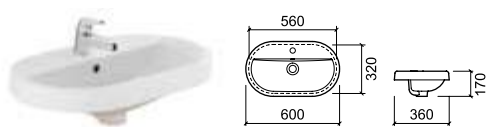

118899

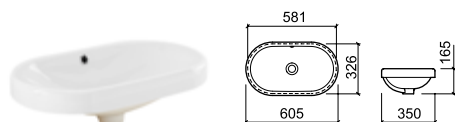

118890

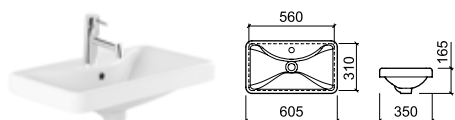

118909

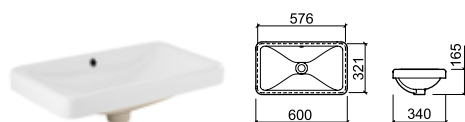

118900

ALICANTE

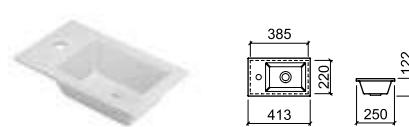

118910



118920

ANNA *

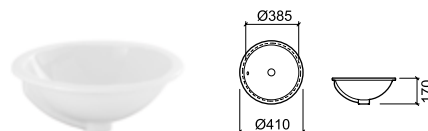

118320

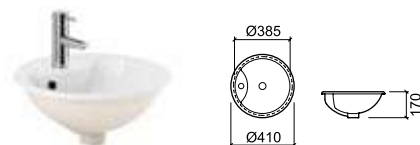

118330

Encastrar por cima
Inset
À encastrer par dessus
Encimera



ÁREA PLUS

ÁREA

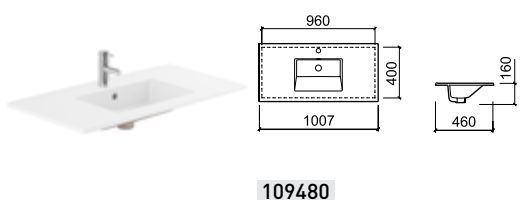
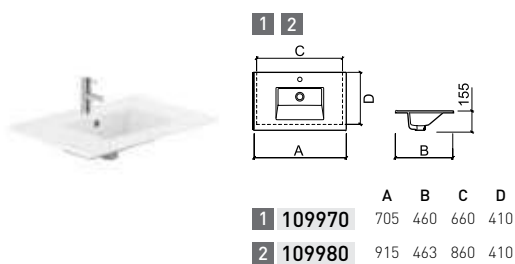

ÁREA PLUS

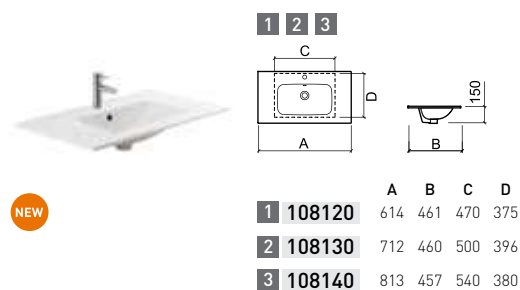

NEW

FRAME

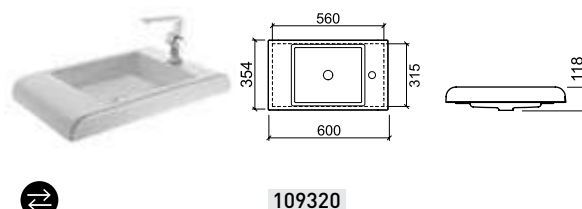

MILLENNIUM *

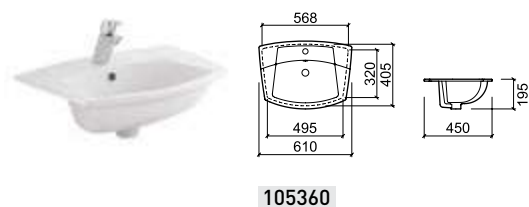

PARIS *

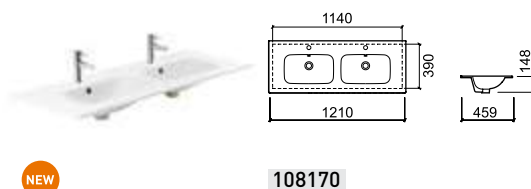

NEW

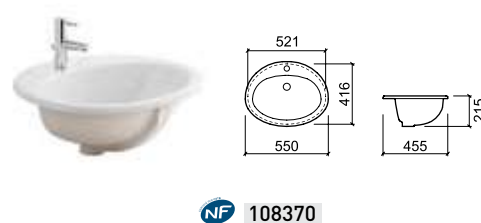

NF





VINTAGE

Encastrar por cima
Inset
À encastrar par dessus
Encimera



TABARCA *

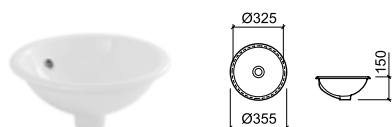

118310

VINTAGE

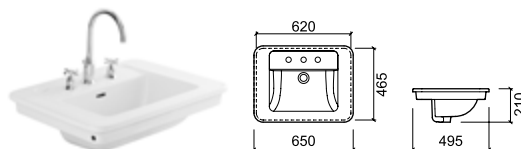

117360 117361 ∞

TEJO *

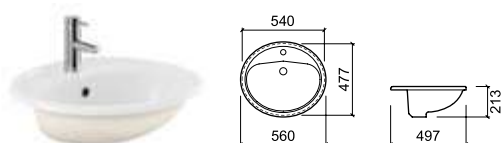

108360

WCA

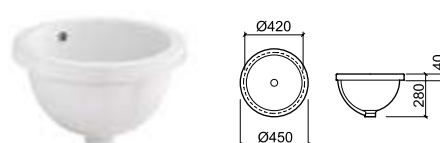

111360





- 1 lavatório note 60x30 | 60x30 note basin | vasque note 60x30 | lavabo note 60x30
- 2 lavatório comby 61x39 | 61x39 comby basin | vasque comby 61x39 | lavabo comby 61x39
- 3 lavatório algar Ø41 | Ø41 algar basin | vasque algar Ø41 | lavabo algar Ø41
- 4 lavatório hi-dden 120x44 | 120x44 hi-dden basin | vasque hi-dden 120x44 | lavabo hi-dden 120x44

Pousar
Vessel
À poser
Sobre encimera



- 1 **lavatório novelda plus 60x45** | 60x45 novelda plus basin | vasque novelda plus 60x45 | lavabo novelda plus 60x45
- 2 **lavatório status 51x39** | 51x39 status basin | vasque status 51x39 | lavabo status 51x39
- 3 **lavatório sanlife 60x42** | 60x42 sanlife basin | vasque sanlife 60x42 | lavabo sanlife 60x42
- 4 **lavatório vista 47x35 + tampa** | 47x35 vista basin + lid | vasque vista 47x35 + couvercle | lavabo vista 47x35 + tapa



U





ADVANCE **

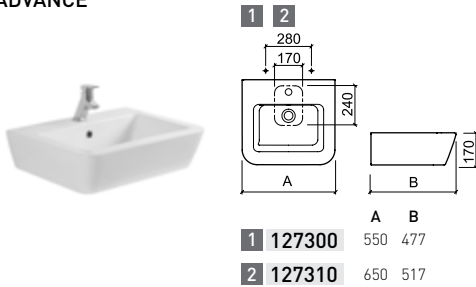

ALGAR *

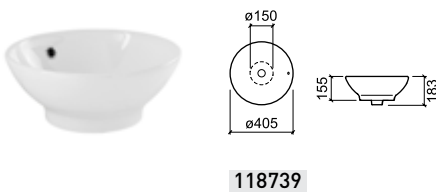

118739

COMBY

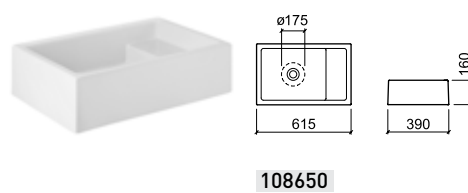

108650

BELFAST ***

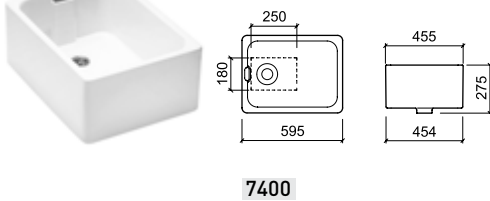

7400

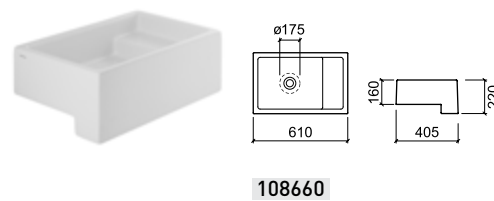

108660

BLOK

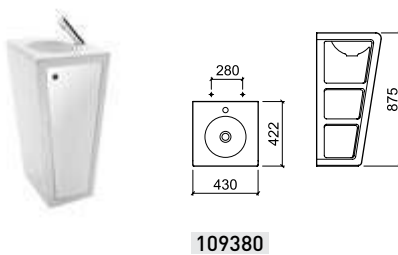

109380



6A8600

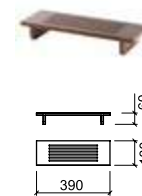

6A8605

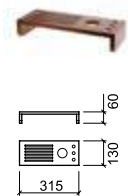

6A8606

Cores | Colours | Couleurs | Colores

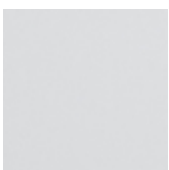

branco
white
blanc
blanco

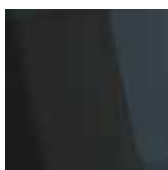

preto
black
noir
negro



zebrano
zebrano
zebrano
zebrano

* disponível em pergamon | available in pergamon | disponible en pergamon | disponible en pergamon

** disponível em preto | available in black | disponible en noir | disponible en negro

*** disponível em antracite mate | available in matte anthracite | disponible en anthracite mat | disponible en antracita mate

Pousar
Vessel
À poser
Sobre encimera



FLOW

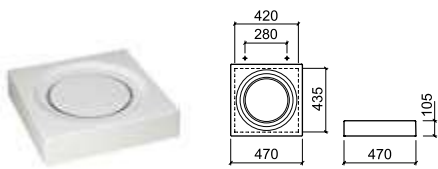

109840

FRAME

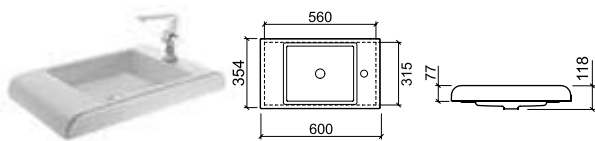

109320

JOIN

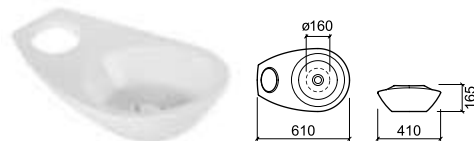

109710



HI-DDEN

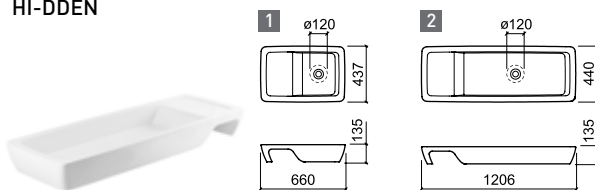

1 109930 2 109940

LOOK *

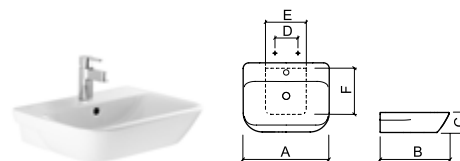

	A	B	C	D	E	F
1 134310	460	416	130	228	200	265
2 134320	500	414	130	280	200	265
3 134330	560	449	130	280	265	300
4 134340	600	449	130	280	265	300
5 134370	660	443	134	278	265	300







MORFYS



MORFYS

Cores | Colours | Couleurs | Colores

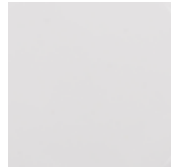

branco
white
blanc
blanco



preto
black
noir
negro



azul
blue
bleu
azul



vermelho
red
rouge
rojo



laranja
orange
naranja



verde
green
vert
verde

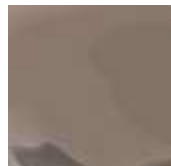

cobre
copper
cuivre
cobre



dourado
gold
doré
dorado

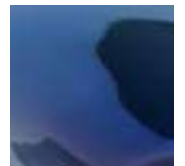

rainbow

MORFYS

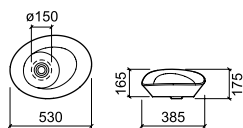

108970

Pousar
Vessel
À poser
Sobre encimera

NOTE

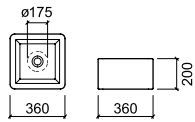

109720

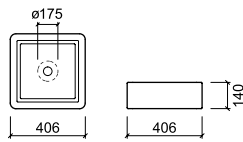

109340

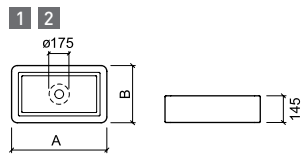

	A	B
1 109360	500	300
2 109950	600	425

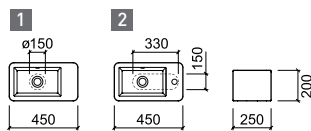

1 109739 2 109730

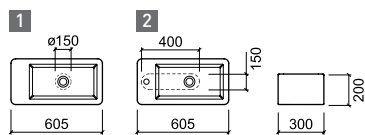

1 109309 2 109300

NOTE

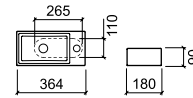

108100

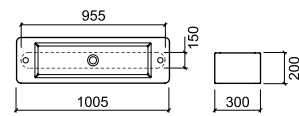

109310

NOVELDA PLUS *

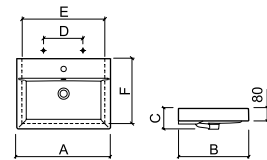

	A	B	C	D	E	F
1 118100	500	455	140	275	460	435
2 118110	606	456	140	285	565	430
3 118120	705	455	133	283	650	425

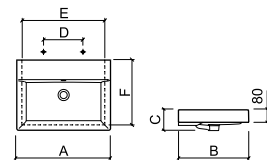

	A	B	C	D	E	F
1 118109	500	455	140	275	460	435
2 118119	606	456	140	285	565	430
3 118129	705	455	133	283	650	425

POLOP

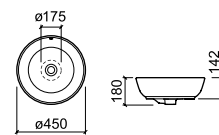

118840



NOTE



RING



RING

Cores | Colours | Couleurs | Colores



branco
white
blanc
blanco



branco + prateado
white + silver
blanc + argent
blanco + plata



branco + dourado
white + gold
blanc + doré
blanco + dorado



RING

RING

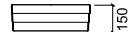
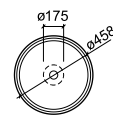

109390

Pousar
Vessel
À poser
Sobre encimera



ROUND

Cores | Colours | Couleurs | Colores



branco
white
blanc
blanco



****violeta mate + branco**
matte violet + white
violet mat + blanc
violeta mate + blanco



****azul mate + branco**
matte blue + white
bleu mat + blanc
azul mate + blanco



****lima mate + branco**
matte lime + white
chaux mat + blanc
lima mate + blanco



****preto mate + branco**
matte black + white
noir mat + blanc
negro mate + blanco



****branco mate**
matte white
blanc mat
blanco mate



****preto mate**
matte black
noir mat
negro mate



****dourado mate**
matte gold
doré mat
dorado mate



****branco mate + dourado mate**
matte white + matte gold
blanc mat + doré mat
blanco mate + dorado mate

ROUND

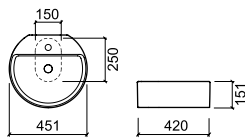

108110

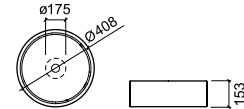

108980 *

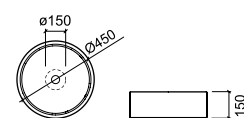

108990 **







SANIBOLD



SANIBOLD

Cores | Colours | Couleurs | Colores



branco
white
blanc
blanco



preto mate + branco
matte black + white
noir mat + blanc
negro mate + blanco



branco mate
matte white
blanc mat
blanco mate



azul mate + branco
matte blue + white
bleu mat + blanc
azul mate + blanco



lima mate + branco
matte lime + white
chaux mat + blanc
lima mate + blanco



*** taupe mate**
matte taupe
taupe mat
taupe mate

SANIBOLD

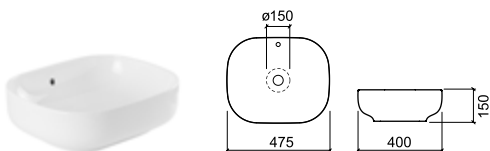

137300 *

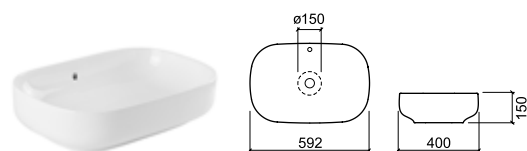

137310

Pousar
Vessel
À poser
Sobre encimera

SANPROJECT

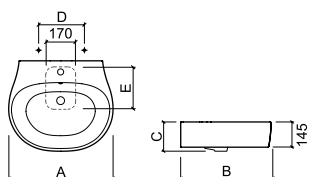

	A	B	C	D	E
1 139300	504	447	175	190	240
2 139310	603	517	170	280	250
3 139320	700	550	172	280	300

SANLIFE

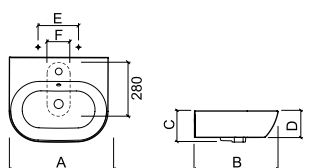

	A	B	C	D	E	F
1 136300	500	435	161	140	200	120
2 136310	600	440	165	145	280	140
3 136320	698	440	170	147	280	140



SANPROJECT

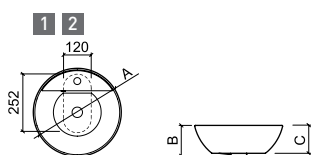

	A	B	C
1 136370	380	135	120
2 136770	420	143	122

SANLIFE

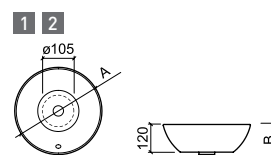

	A	B
1 136379	380	130
2 136779	420	140

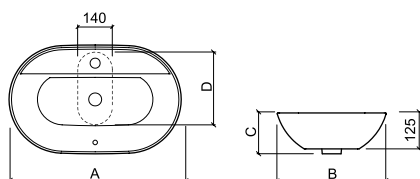

	A	B	C	D
1 136380	595	378	142	250
2 136780	600	422	142	250
3 136390	795	375	143	250
4 136790	802	426	144	252

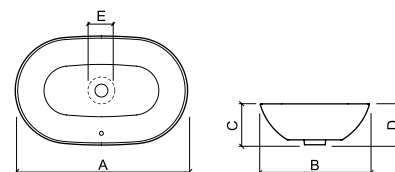

	A	B	C	D	E
1 136389	595	380	140	125	180
2 136789	600	420	142	124	150
3 136399	800	380	143	127	150
4 136799	796	424	142	125	150





SANLIFE

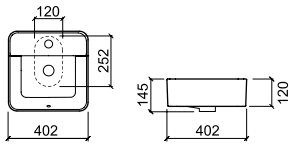

136720

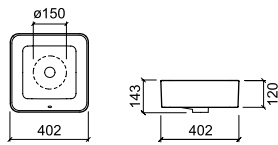

136729



SANLIFE

SIGN *

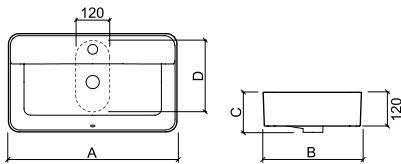

	A	B	C	D
1 136330	600	350	143	252
2 136730	602	400	145	250
3 136340	800	350	140	252
4 136740	802	398	145	252

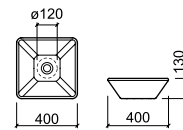

108930

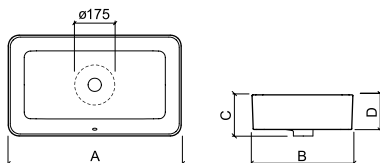

	A	B	C	D
1 136339	602	352	145	122
2 136739	602	400	145	122
3 136349	800	350	140	120
4 136749	800	400	144	120

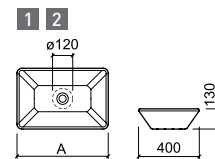

	A
1 108940	605
2 108950	800

Pousar
Vessel
À poser
Sobre encimera



VISTA

STATUS

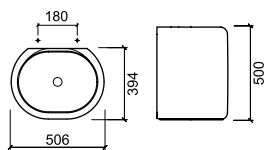

123330

UNU

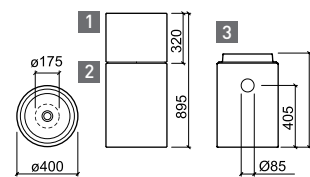

1 109740 2 109209 3 109200

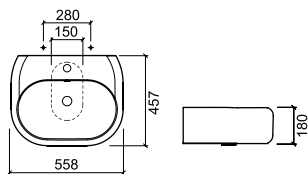

123310

VISTA *

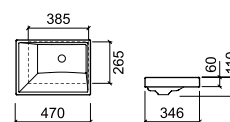

109450 1T9410

TRIBO

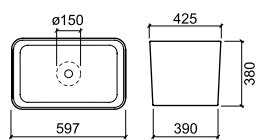

109900

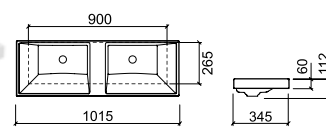

109460 1T9410

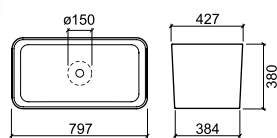

109910



1T9410







- 1 lavatório advance 58x46 | 58x46 advance basin | vasque advance 58x46 | lavabo advance 58x46
- 2 lavatório look 83x47 | 83x47 look basin | vasque look 83x47 | lavabo look 83x47
- 3 lavatório status 61x41 | 61x41 status basin | vasque status 61x41 | lavabo status 61x41
- 4 lavatório flat 63x35 | 63x35 flat basin | vasque flat 63x35 | lavabo flat 63x35



ADVANCE **

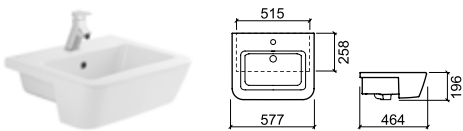

127350

FLAT

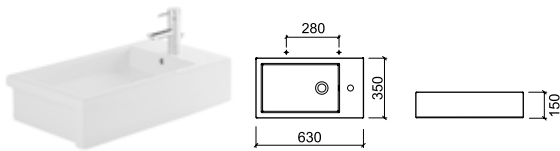

109890

LOOK *

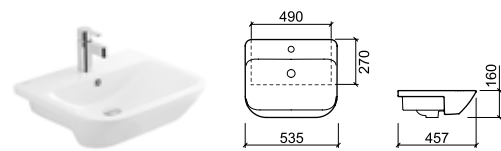

134380

LINHA *

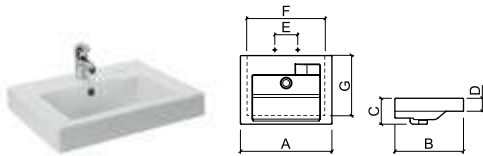

	A	B	C	D	E	F	G
1 108870	550	450	185	85	284	470	370
2 108880	600	455	185	85	285	510	380
3 108890	700	450	180	80	287	560	370
4 108900	805	450	185	85	280	660	370

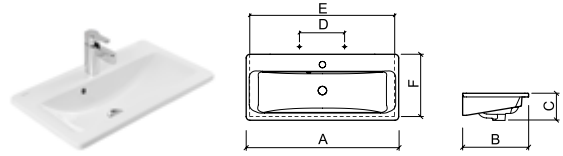

	A	B	C	D	E	F
1 134770	632	363	162	285	590	338
2 134780	835	365	137	282	790	340

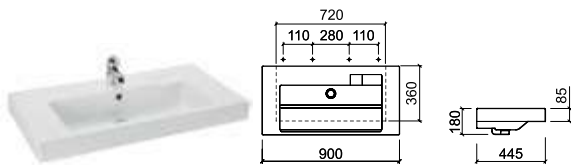

108910

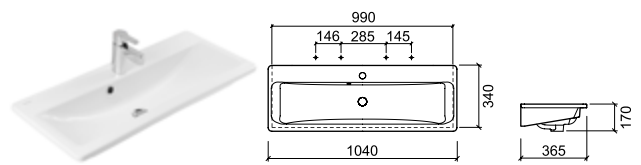

134790

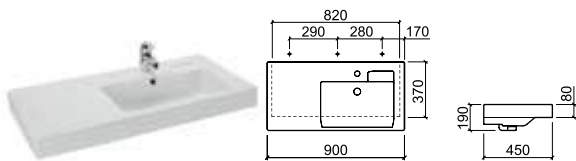

108920

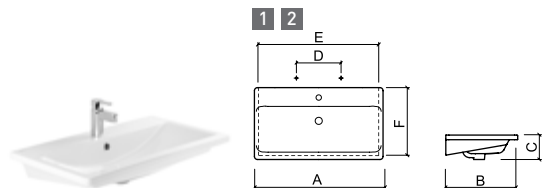

	A	B	C	D	E	F
1 134350	637	465	168	280	595	445
2 134360	832	465	177	277	790	443

* disponível em pergamon | available in pergamon | disponible en pergamon | disponible en pergamon

** disponível em preto | available in black | disponible en noir | disponible en negro

Semi-encastar
Semi recessed
Semi-encastrés
Semiempotrar

PALM *

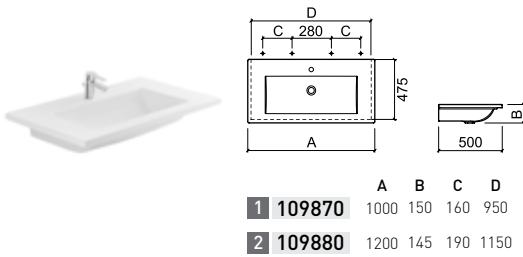
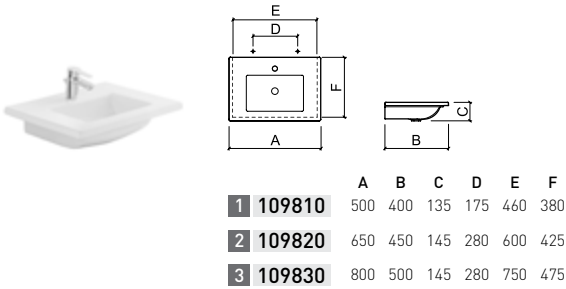

STATUS

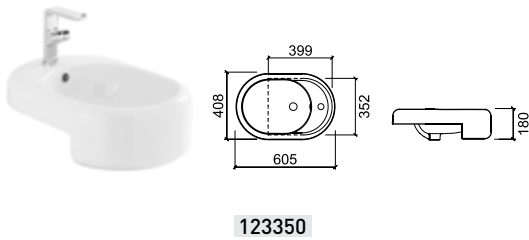

URB.Y *

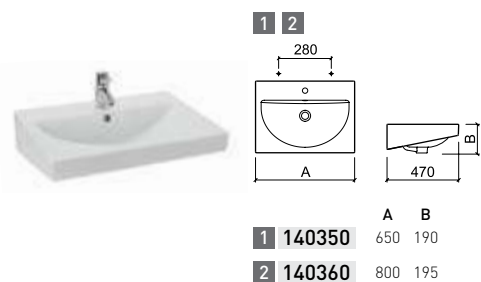
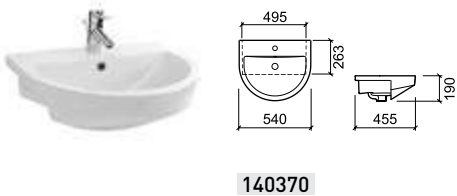

URB.Y PLUS *

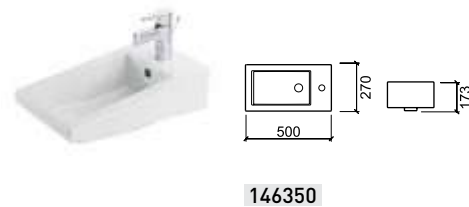

VALÊNCIA *

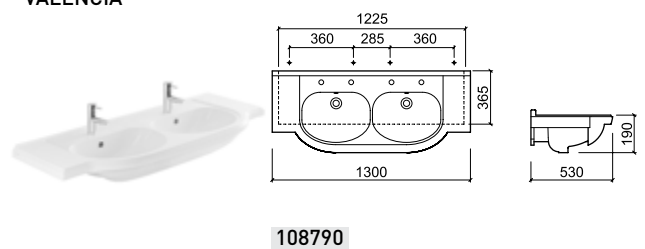







- 1 lavatório status 51x39 | 51x39 status basin | lavabo status 51x39 | lavabo status 51x39
- 2 lavatório novelda plus 60x45 | 60x45 novelda plus basin | lavabo novelda plus 60x45 | lavabo novelda plus 60x45
- 3 lavatório advance 40x25 | 40x25 advance basin | lavabo advance 40x25 | lavabo advance 40x25
- 4 lavatório vista 50x43 | 50x43 vista basin | lavabo vista 50x43 | lavabo vista 50x43

Parede
Wall mounted
Mural
Mural



- 1 lavatório clean 83x47 | 83x47 clean basin | lavabo clean 83x47 | lavabo clean 83x47
- 2 lavatório sanlife 40x40 | 40x40 sanlife basin | lavabo sanlife 40x40 | lavabo sanlife 40x40
- 3 lavatório clean 83x47 com toalheiro | 83x47 clean basin with towel rack | lavabo clean 83x47 avec porte serviettes | lavabo clean 83x47 con toallero
- 4 lavatório advance 90x52 | 90x52 advance basin | lavabo advance 90x52 | lavabo advance 90x52







ADVANCE *

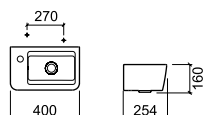

127330

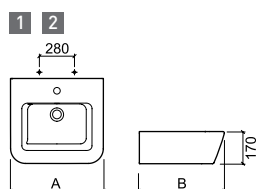

1 127300 550 477
2 127310 650 517

CLEAN

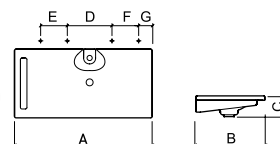

	A	B	C	D	E	F	G
1 108410	715	465	140	280	-	-	-
2 108430	920	465	150	280	145	145	132
3 108450	1112	468	149	285	224	220	147

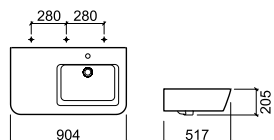

127320

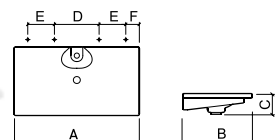

	A	B	C	D	E	F
1 108400	630	465	145	280	175	-
2 108420	835	465	146	280	145	132
3 108440	1030	470	150	285	220	148

BLEND

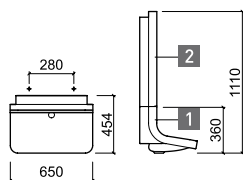

1 109330 2 66271

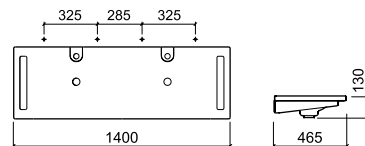

108470

CETUS BASIC

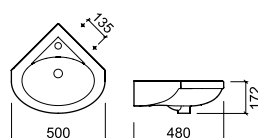

135700

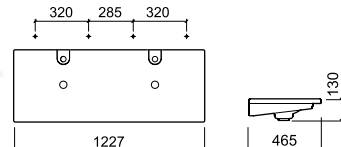

108460

Parede
Wall mounted
Mural
Mural



DOURO

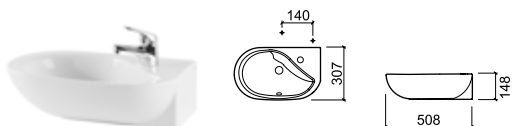

118300

EASY *

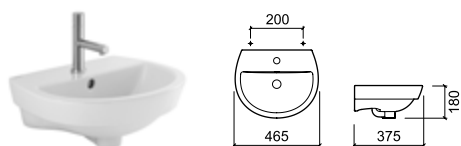

131300

FLOW

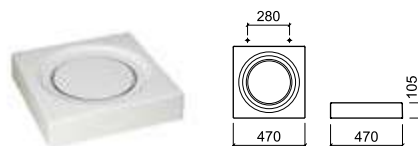

109840

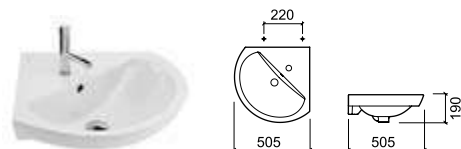

131700

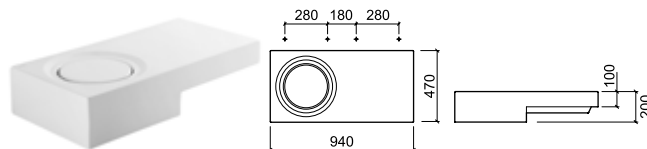

109850







FLUX



FLUX

FLUX

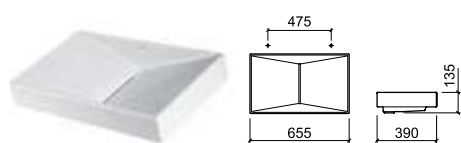

109750 40906

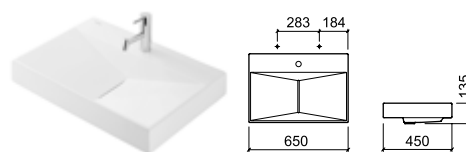

109700 40906

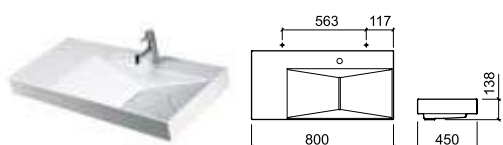

109760 40908

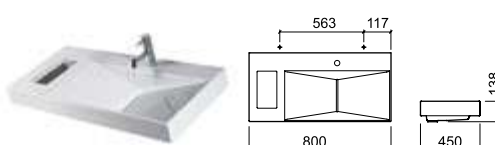

109770

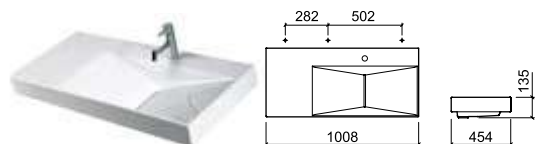

109780 40910

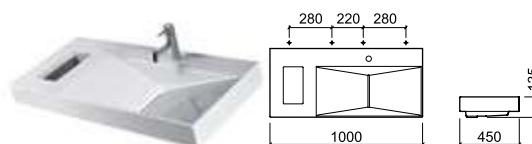

109790

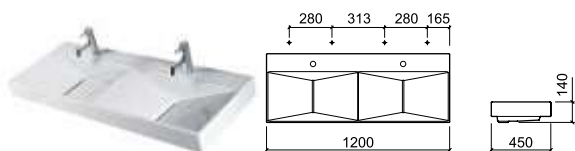

109800 40912



- 40906 650
- 40908 800
- 40910 1000
- 40912 1200

Parede
Wall mounted
Mural
Mural

LOOK *

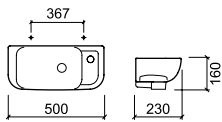

134390

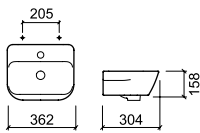

134300

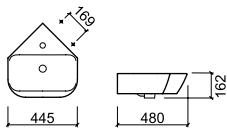

134700

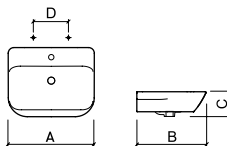

	A	B	C	D
1 134310	460	416	160	228
2 134320	500	414	165	280
3 134330	560	449	165	280
4 134340	600	449	165	280
5 134370	660	443	162	278



LOOK

MIRA *

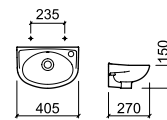

108310

MONDEGO

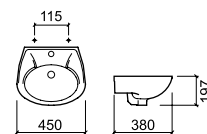

108340





NOTE



NOTE

NOTE

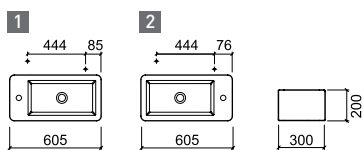

1 109300D 2 109300E

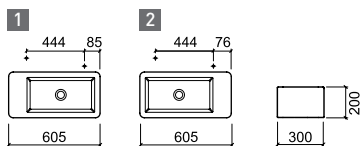

1 109309D 2 109309E

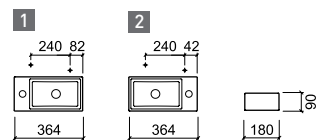

1 108100D 2 108100E

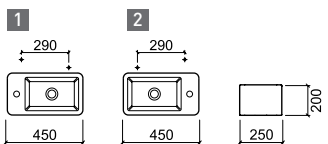

1 109730D 2 109730E

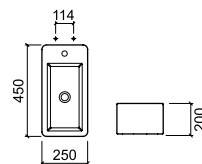

109730F

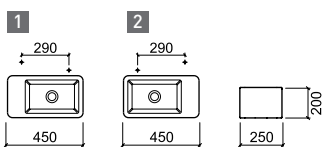

1 109739D 2 109739E

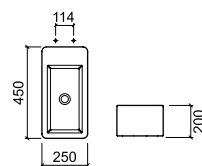

109739F

Parede
Wall mounted
Mural
Mural

NOVELDA PLUS *

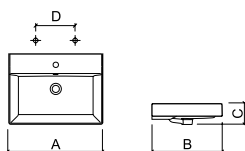

	A	B	C	D
1 118100	500	455	140	275
2 118110	606	456	140	285
3 118120	705	455	133	283



NOVELDA PLUS

PLAN *

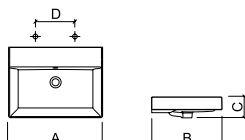

	A	B	C	D
1 118109	500	455	140	275
2 118119	606	456	140	285
3 118129	705	455	133	283

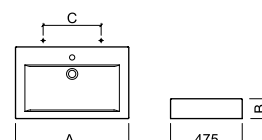

	A	B	C
1 108800	495	130	226
2 108810	750	135	475

PALM *

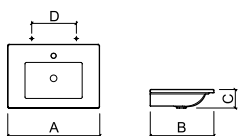

	A	B	C	D
1 109810	500	400	135	175
2 109820	650	450	145	280
3 109830	800	500	145	280

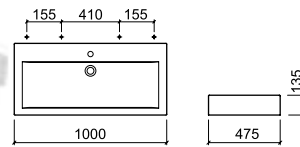

108820

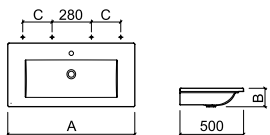

	A	B	C
1 109870	1000	150	160
2 109880	1200	145	190

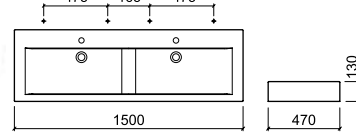

108830





SADO

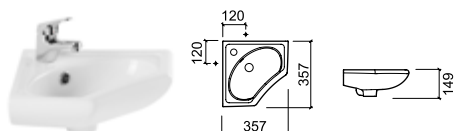

118700



SADO

SANLIFE

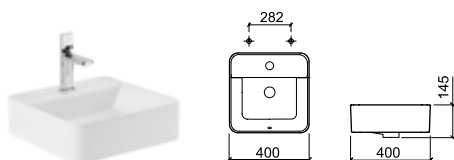

136950

STATUS

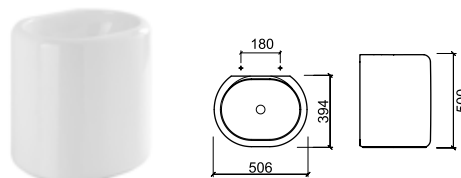

123330

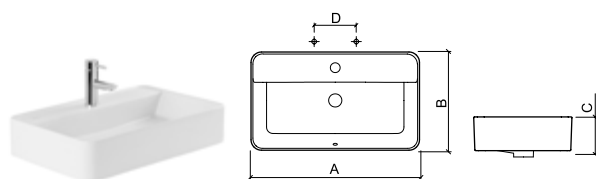

	A	B	C	D
1 136900	600	350	143	285
2 136910	602	400	144	285
3 136920	800	350	143	280
4 136930	802	400	143	282

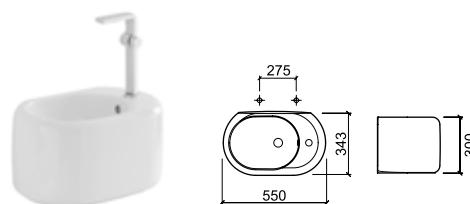

123300

SANPROJECT

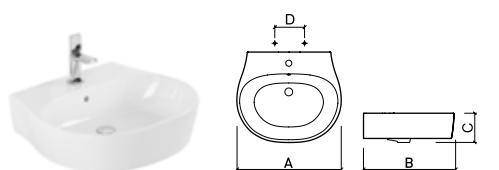

	A	B	C	D
1 139300	504	447	175	190
2 139310	603	517	170	280
3 139320	700	550	172	280

URB.Y *

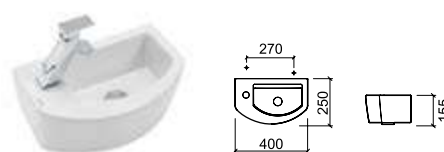

140330

Parede
Wall mounted
Mural
Mural

VISTA *

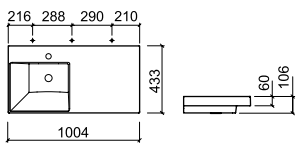
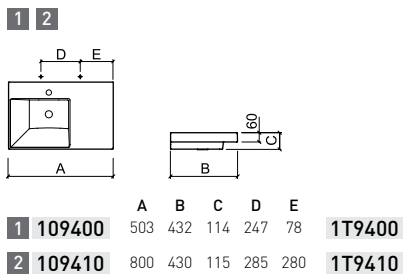

109420 1T9410

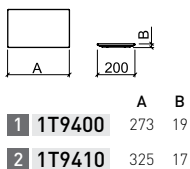
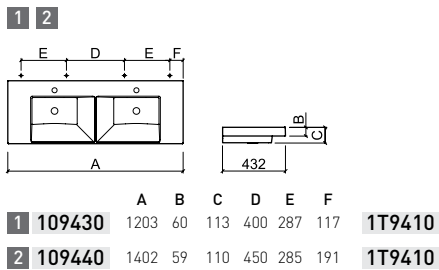

WCA

WCA

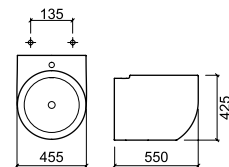

111340

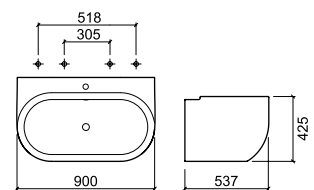

111770







Coleções
Collections
Collections
Colecciones

- 174 WCA
- 178 Sanlife
- 182 Status
- 184 Sanibold
- 185 Urb.Y Plus
- 186 Look
- 188 View NEW
- 192 Round
- 193 Join
- 194 Flow
- 196 Clean
- 200 Área
- 206 Hi-dden
- 208 Vista
- 210 Frame
- 211 Flat
- 212 Flux
- 213 Alicante
- 214 Emma
- 216 Riba

Espelhos
Mirrors
Miroirs
Espejos

- 217 My Face





PÉS | SUPPORT LEGS | PIEDS | PATAS

Alguns modelos de móveis de casa de banho demonstram versatilidade na medida que possibilitam uma aplicação suspensa ou ao chão. Os **pés**, de diferentes formatos e medidas, quando aplicados conferem uma sensação de estabilidade e um estilo mais clássico ao produto.

Bathroom furniture is very versatile since it can be installed on the floor or on the wall. **Support legs** of different shapes and sizes when added to furniture give the product a sense of stability and a classic look.

Certains modèles de meubles de salle de bains font preuve de polyvalence car ils peuvent être suspendus ou posés au sol. Les **pieds**, de formes et de tailles différentes, lorsqu'ils sont appliqués, donnent au produit un sentiment de stabilité et un style plus classique.

Algunos modelos de muebles de baño son versátiles, ya que permiten su colocación tanto suspendidos como en el suelo. Las **patas**, de diferentes formas y tamaños, se pueden colocar proporcionándole al producto una sensación de estabilidad y un estilo más clásico.



CLICK

O sistema **Click** permite, através de um simples toque na superfície do móvel, abrir ou fechar as gavetas e portas, dispensando a aplicação de puxadores exteriores ou integrados. Os móveis com esta característica traduzem um design mais "clean" e minimalista, facilitando na hora da limpeza.

The **Click** system allows you to open or close drawers and doors without visible or integrated handles by simply touching the surface of the furniture. This feature enhances the units and gives them an easy to clean minimalist look.

Le système **Click** permet d'ouvrir ou de fermer les tiroirs et les portes en touchant simplement la surface du meuble, sans avoir besoin de poignées externes ou intégrées. Les meubles dotés de cette caractéristique se traduisent par un design plus propre et minimaliste, ce qui facilite le nettoyage.

El sistema **Click** permite abrir o cerrar cajones y puertas con un simple toque en la superficie del mueble, sin necesidad de tiradores externos o integrados. Los muebles con esta característica mantienen un diseño más limpio y minimalista, facilitando la limpieza.



SMOOVE

É o chamado **fecho amortecido** para gavetas ou portas nos móveis, que desliza suavemente e de forma silenciosa. Este sistema de fecho favorece a durabilidade do móvel uma vez que evita os fortes embates e o ruído.

It's a **shock absorbing system** for drawers and doors which makes them slide smoothly and silently for a soft close. This closing system maintains and preserves the furniture adding durability while avoiding strong impacts and noise.

C'est le **système de fermeture amorti** pour les tiroirs ou portes de meuble qui glisse en douceur et silencieusement. Ce système de fermeture prolonge la durabilité du meuble puisqu'elle évite les chocs et le bruit.

Se llama **cierre amortiguado** para cajones o puertas de muebles, que se desliza suave y silenciosamente. Este sistema de cierre añade durabilidad a los muebles, ya que evita los impactos fuertes y el ruido.



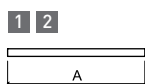
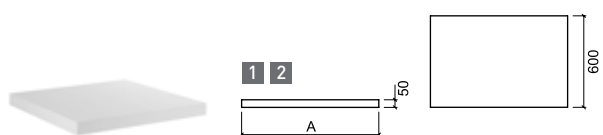

- 1 61190 A 600
- 2 61191 A 900

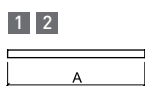
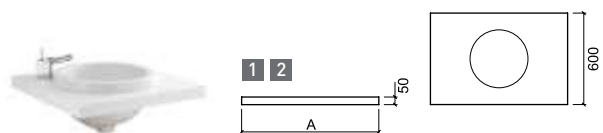

- 1 61192 A 600
 - 2 61193 A 900
- 111360

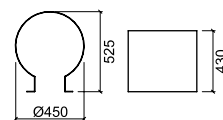

61130

WCA

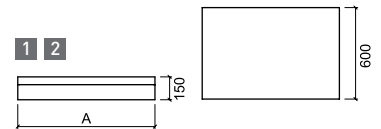
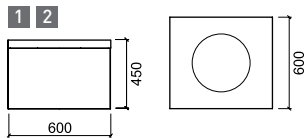

1 61103 
2 61102  111360 

A
1 61100 600
2 61101 900

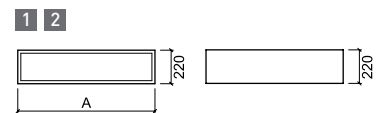
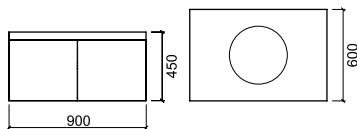

61104 111360 

A
1 61133 600
2 61134 900

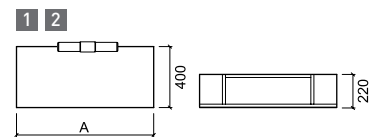
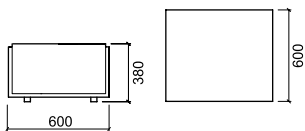

61120

A
1 61170 600
2 61171 900

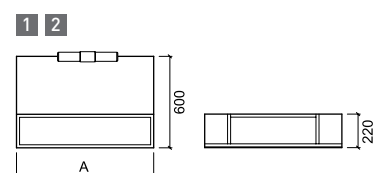
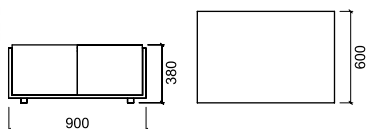

61121

A
1 61172 600
2 61173 900





SANLIFE



Cores | Colours | Couleurs | Colores



branco
white
blanc
blanco



branco/taupe
white/taupe
blanc/taupe
blanco/taupe

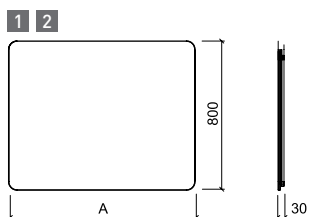
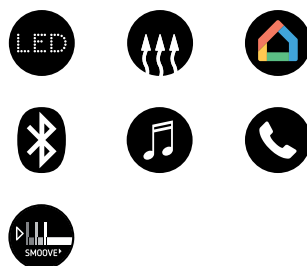

	A
1 61970	1000
2 61972	1600

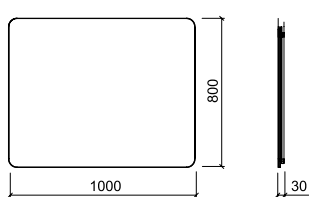

61978

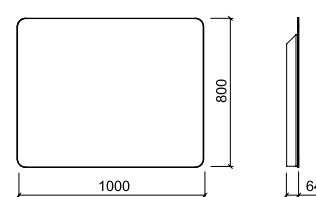

61979



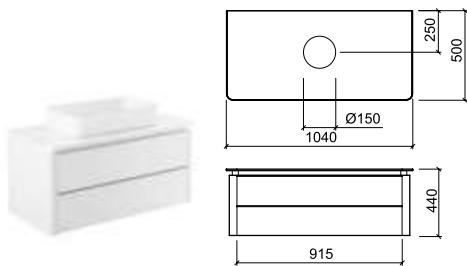

691990 1

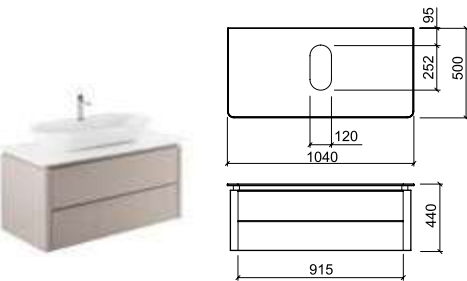

691992 2

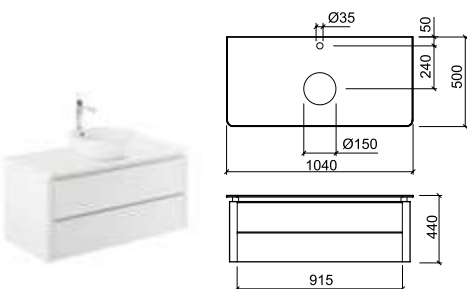

691991 1

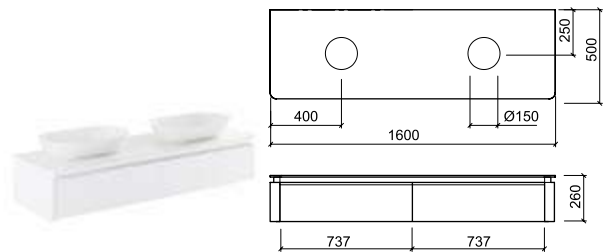

691996 3

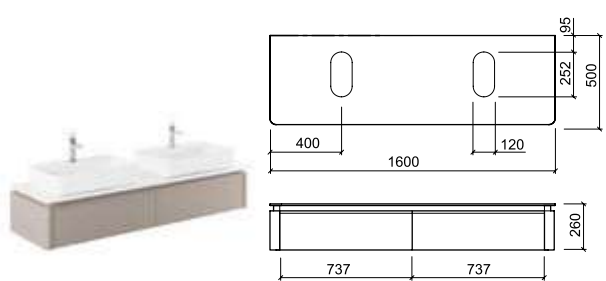

691998 4

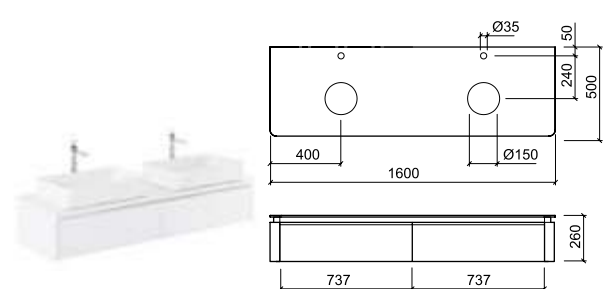

691997 3

1



136339 136799
136349 136379
136739 136779
136749 136729
136389
136399
136789

2



136330 136790
136340 136370
136730 136770
136740 136720
136380
136390
136780

3



136339
136739
136389
136789
136379
136779
136729

4



136330
136730
136380
136780
136370
136770
136720



STATUS

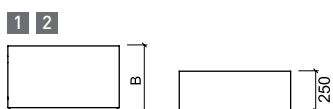

	1	2	A	B	
1	62320		600	410	
2	62300		750	390	123330

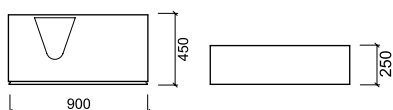

62321	123310	
-------	--------	--

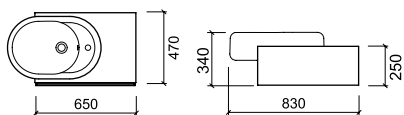

62301	123350	
-------	--------	--

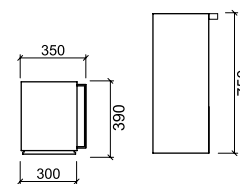

62331

SANIBOLD

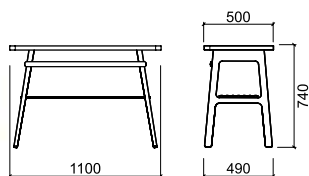

61801 137300
137310



URB.Y PLUS



Cores | Colours | Couleurs | Colores

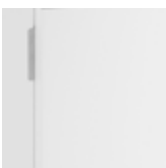

branco
white
blanc
blanco



nogueira
walnut
noyer
nogal

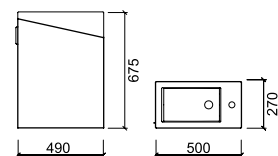

64602 146350



LOOK



Cores | Colours | Couleurs | Colores



branco
white
blanc
blanco



cinza aluminio
aluminium grey
gris aluminium
gris aluminio

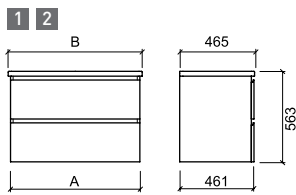

	1	2	A	B	
	63420	603	637	134350	
	63421	803	832	134360	

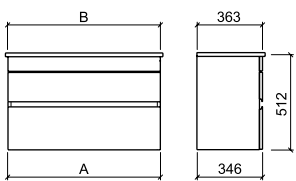

	1	2	3	A	B	
	63430	600	632	134770		
	63431	805	832	134780		
	63440	1000	1032	134790		

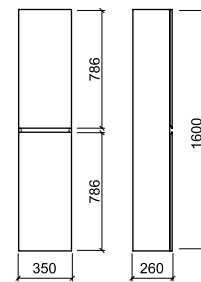

63402





Cores | Colours | Couleurs | Colores

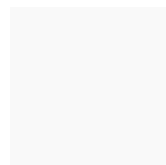

branco
white
blanc
blanco



nogueira
walnut
noyer
nogal



3 5

3 4



- 1 **móvel view 90** | 90 view furniture | meuble view 90 | mueble view 90
- 2 **lavatório round Ø40** | Ø40 round basin | lavabo round Ø40 | lavabo round Ø40
- 3 **móvel view 90** | 90 view furniture | meuble view 90 | mueble view 90
- 4 **lavatório sanibold 48x40** | 48x40 sanibold basin | lavabo sanibold 48x40 | lavabo sanibold 48x40
- 5 **lavatório sanlife 40x40** | 40x40 sanlife basin | lavabo sanlife 40x40 | lavabo sanlife 40x40



VIEW

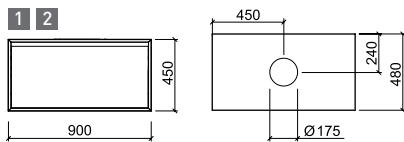

NEW

1 63020 2 63028 LED 3

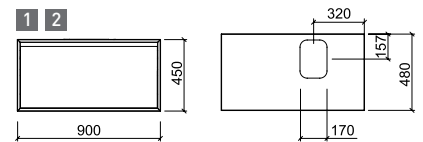

NEW

1 63030 2 63038 LED 4

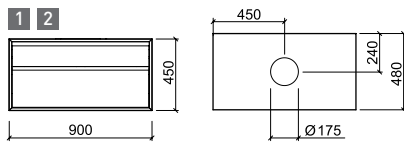

NEW

1 63021 2 63029 LED 3

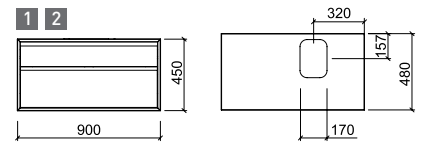

NEW

1 63031 2 63039 LED 4

3

108650	109340	109930	136389
108930	109360	109950	136399
108940	109390	118739	137130
108950	109720	118840	137300
108970	109740	136339	7400
108980	109900	136349	
108990	109910	136379	

4

108110	134340
127300	134370
127310	134370
127320	136720
134310	136730
134320	136780
134330	139300

ROUND

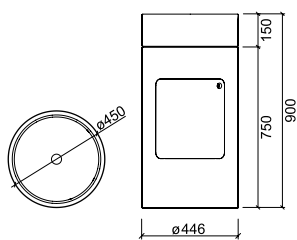

67530 108990 

Cores | Colours | Couleurs | Colores



branco/cortiça
white/cork
blanc/liège
blanco/corcho



cortiça
cork
liège
corcho



Cores | Colours | Couleurs | Colores



1
vidro
glass
verre
vidrio



2
lacado
lacquered
laqué
lacado

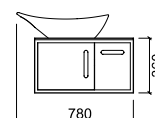
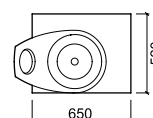

1 64401
2 64400

109710





FLOW

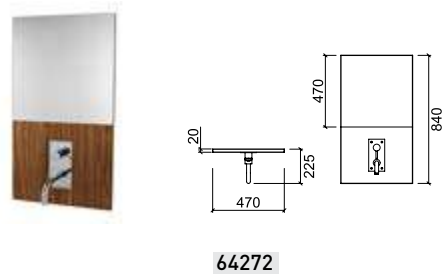
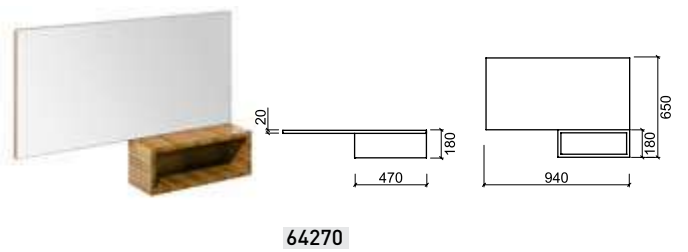
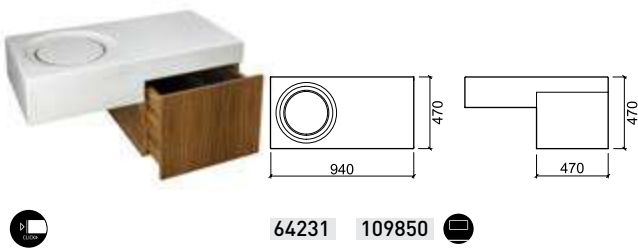



CLEAN



Cores | Colours | Couleurs | Colores



branco
white
blanc
blanco



nogueira
walnut
noyer
nogal



- 1 **móvel clean 63** | 63 clean furniture | meuble clean 63 | mueble clean 63
- 2 **lavatório clean 63 com toalheiro** | 63 clean basin with towel rail | lavabo clean 63 avec porte-serviettes | lavabo clean 63 con toallero
- 3 **lavatório clean 63** | 63 clean basin | lavabo clean 63 | lavabo clean 63
- 4 **móvel clean 83** | 83 clean furniture | meuble clean 83 | mueble clean 83
- 5 **lavatório clean 83** | 83 clean basin | lavabo clean 83 | lavabo clean 83
- 6 **móvel clean 103** | 103 clean furniture | meuble clean 103 | mueble clean 103
- 7 **lavatório clean 103 com toalheiro** | 103 clean basin with towel rail | lavabo clean 103 avec porte-serviettes | lavabo clean 103 con toallero



CLEAN

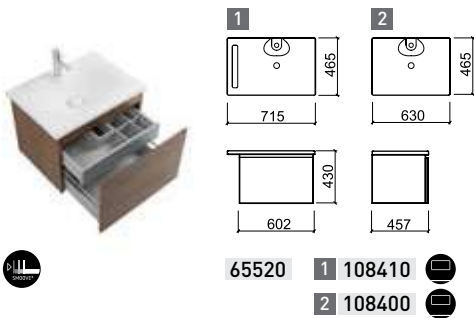

packs
695521 + 65520 + 108410
695520 + 65520 + 108400

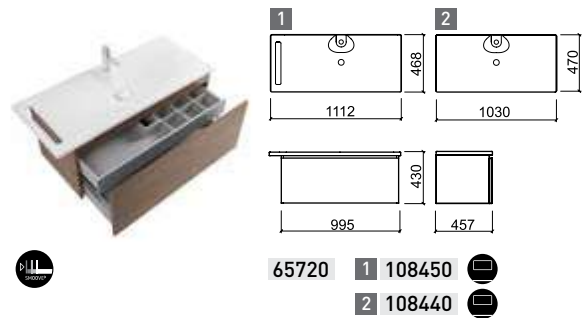

packs
695721 + 65720 + 108450
695720 + 65720 + 108440

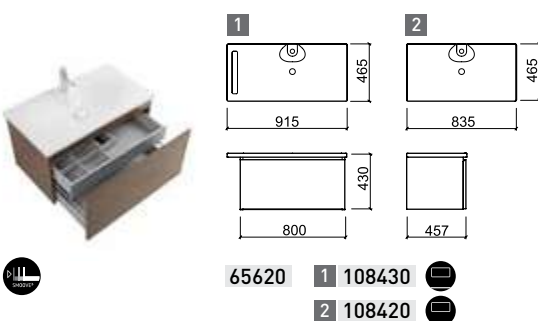

packs
695621 + 65620 + 108430
695620 + 65620 + 108420

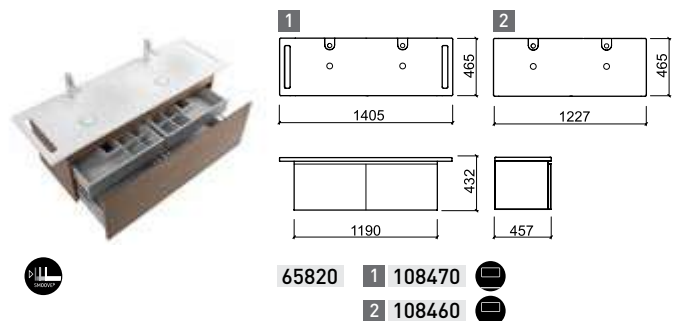

packs
695821 + 65820 + 108470
695820 + 65820 + 108460





Cores | Colours | Couleurs | Colores



branco
white
blanc
blanco



cuzco



vermelho
red
rouge
rojo



preto
black
noir
negro



bege texturado
textured beige
beige texturé
beige con textura



tulipié fumé texturado
textured tulipié fumé
tulipié fumé texturé
tulipié fumé con textura

- 1 **móvel área 80** | 80 área furniture | meuble área 80 | mueble área 80
- 2 **lavatório área plus 81** | 81 área plus basin | lavabo área plus 81 | lavabo área plus 81
- 3 **espelho área 80** | 80 área mirror | miroir área 80 | espejo área 80
- 4 **móvel área 120** | 120 área furniture | meuble área 120 | mueble área 120
- 5 **lavatório área plus 121** | 121 área plus basin | lavabo área plus 121 | lavabo área plus 121
- 6 **espelho área 120** | 120 área mirror | miroir área 120 | espejo área 120



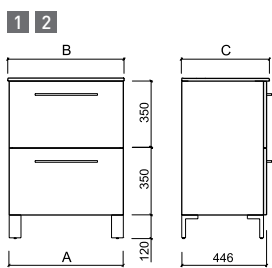

	A	B	C	
1 65121	600	614	461	108120
2 65321	800	813	457	108140

695123	695321
+ 65121	+ 65321
+ 108120	+ 108140

695172	695272
+ 65121	+ 65321
+ 108120	+ 108140
+ 65170	+ 65370

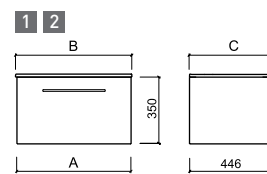

	A	B	C	
1 65120	600	614	461	108120
2 65320	800	813	457	108140

695120	695320
+ 65120	+ 65320
+ 108120	+ 108140

695170	695370
+ 65120	+ 65320
+ 108120	+ 108140
+ 65170	+ 65370

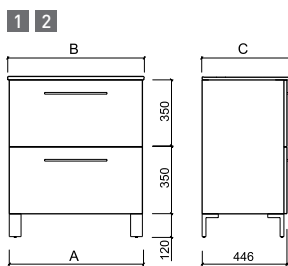

	A	B	C	
1 65221	700	705	460	109970
				108130
2 67621	900	915	463	109980

695221	697621
+ 65221	+ 67621
+ 109970	+ 109980

695272	697672
+ 65221	+ 67621
+ 109970	+ 109980
+ 65270	+ 67670

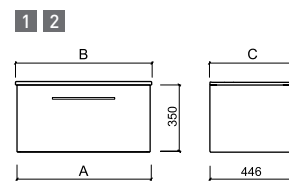

	A	B	C	
1 65220	700	705	460	109970
				108130
2 67620	900	915	463	109980

695220	697620
+ 65220	+ 67620
+ 109970	+ 109980

695270	697670
+ 65220	+ 67620
+ 109970	+ 109980
+ 65270	+ 67670

ÁREA

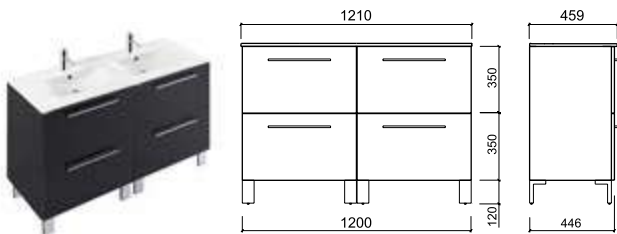

65131 108170

pack
695122
 + 65131
 + 108170

pack
695173
 + 65131
 + 108170
 + 65171

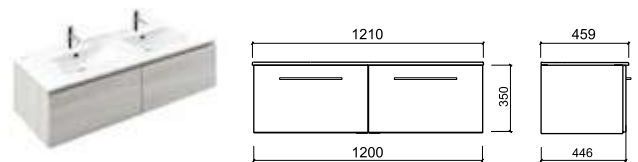

65130 108170

pack
695121
 + 65130
 + 108170

pack
695171
 + 65130
 + 108170
 + 65171

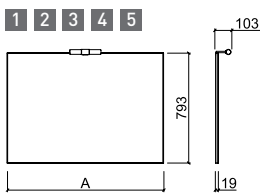

	A
1 65170	592
2 65270	692
3 65370	792
4 67670	892
5 65470	992

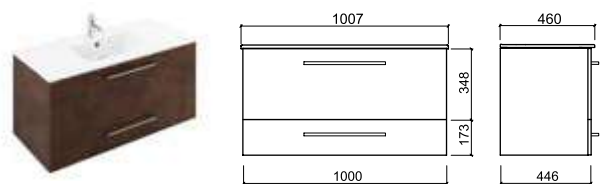

65421 109480

pack
695421
 + 65421
 + 109480

pack
695470
 + 65421
 + 109480
 + 65470

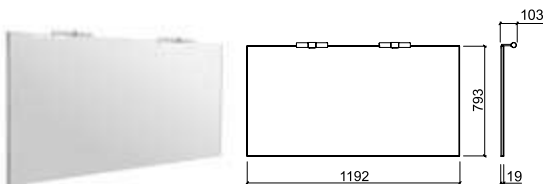



65171





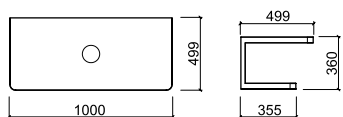

HI-DDEN

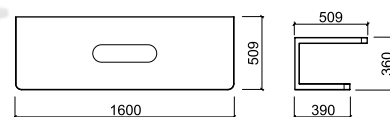

61601 109930  



61602 109940  

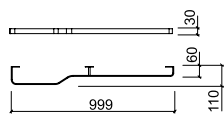

41606

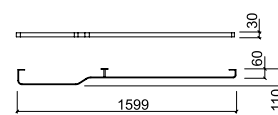

41607



VISTA

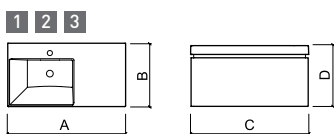

	A	B	C	D	
1 60802	503	432	496	414	109400
2 60820	800	430	796	413	109410
3 60821	1004	433	996	413	109420

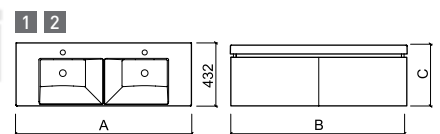



	A	B	C	
1 60830	1203	1195	418	109430
2 60831	1402	1396	413	109440

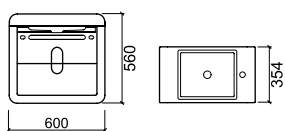

FRAME



109599 109320  

FLAT

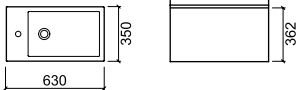

64302 109890 

FLUX

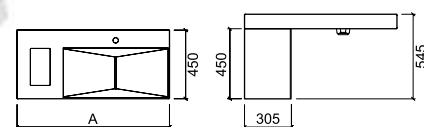

1	60920	60900	109770	A	800	
			109790	1000		

ALICANTE



Cores | Colours | Couleurs | Colores



branco
white
blanc
blanco



faia
beech
hêtre
haya

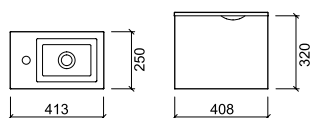

61401 118910

pack
691401
+ 61401
+ 118910
+ 5580301

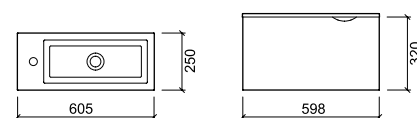

61501 118920

pack
691501
+ 61501
+ 118920
+ 5580301



EMMA



Cores | Colours | Couleurs | Colores



branco
white
blanc
blanco



nogueira
walnut
noyer
nogal

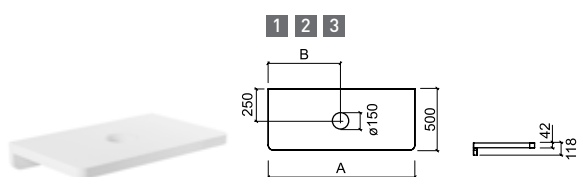

	A	B
1 61091	800	400
2 61092	1000	500
3 61093	1200	600

41606 *

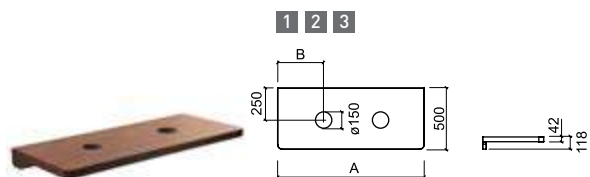

	A	B
1 61094	1200	300
2 61095	1400	350
3 61096	1600	380

41607 *

RIBA

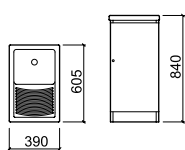

66040 108600 

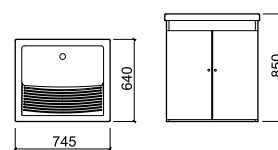

66340 108630 

MY FACE

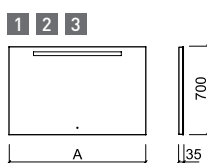

	A
1 66670	800
2 66770	1000
3 66870	1200

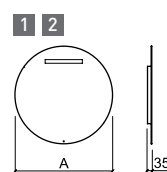

	A
1 67070	Ø650
2 67170	Ø800



PEÇAS ESPECIAIS
SPECIAL PIECES
PIÈCES SPÉCIALES
PIEZAS ESPECIALES

Urinóis
Urinals
Urinoirs
Urinarios

- 220 Like
- 222 Modo
- 222 Cubic
- 223 WCA
- 223 Atlântico
- 224 Forma
- 224 Sanlife NEW
- 225 Jade
- 225 Ria

Separadores
Dividers
Séparateurs
Separadores

- 226 Link
- 226 Wc Kids
- 227 **Sanita turca**
Squat toilet
Wc turc
Placa turca
- 227 **Pia hospitalar**
Slop hopper
Vidoir d'hôpital
Vertedero

Lava-roupas
Laundry sinks
Bacs à laver
Lavaderos

- 228 Blink
- 229 Tribo
- 229 Riba

LIKE

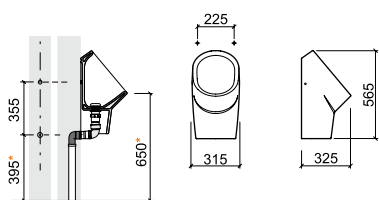

108550

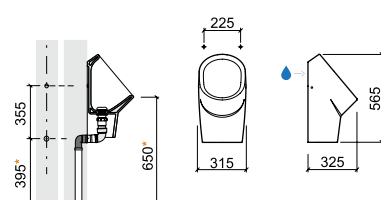

108551

Como funciona o urinol Like?
How does the Like urinal work?
Comment fonctionne l'urinoir Like?
¿Cómo funciona el urinario Like?



Chave de montagem
Assembly key
Clé de montage
Llave de montaje



Anel desodorizante
Deodorising ring
Bague déodorant
Anillo desodorante

O anel desodorizante proporciona um aroma agradável e o diafragma selante previne a emissão de odores do esgoto.

The deodorant ring provides a pleasant smell and the sealing diaphragm prevents the release of sewer odours.

La bague de déodorant et offre un arôme gréable et la membrane d'étanchéité empêche l'émission d'odeurs de l'égout.

El anillo desodorante proporciona un aroma agradable y el diafragma sellador evita la emisión de olores de la alcantarilla.

Válvula
Valve
Vanne
Válvula



Diafragma selante
Sealing diaphragm
Membrane d'étanchéité
Diafragma sellador

Ao passar pela válvula, o fluido provoca a abertura instantânea do diafragma que o conduz sem descarga de água para a canalização. O diafragma fecha por vácuo quando o líquido deixa de circular, impedindo o refluxo.

When the fluid passes the valve it instantly opens the vertical diaphragm flowing without water discharge to the sewage system. When the flow stops the sealing diaphragm closes itself to avoid reflux.

Lors du passage de la vanne, le fluide provoque l'ouverture instantanée de la membrane, menée sans écoulement de l'eau au système des eaux usées. Le diaphragme de vide se ferme lorsque le liquide cesse de couler et d'éviter les reflux.

Al pasar la válvula, el fluido causa la apertura instantánea del diafragma, siendo conducido sin descarga de agua al sistema de alcantarillado. El diafragma de vacío se cierra cuando el fluido deja de fluir para evitar el reflujo.



Para mais informações
For more information
Pour plus d'informations
Para más información

Urinois
 Urinals
 Urinoirs
 Urinarios



MODO

MODO

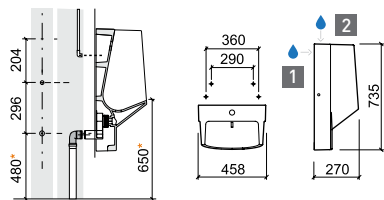

1 108530 2 108531

CUBIC

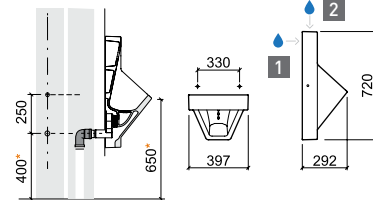

1 108520 2 108521

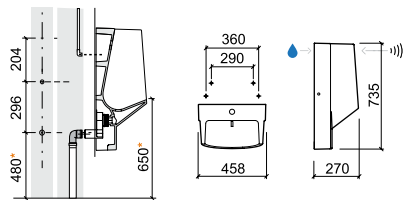

108537

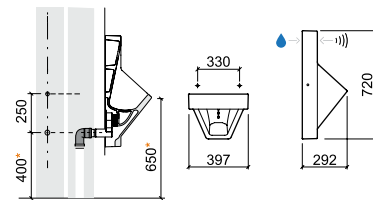

108527



WCA

WCA

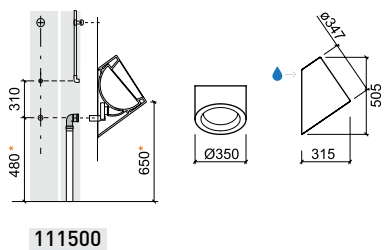

ATLÂNTICO

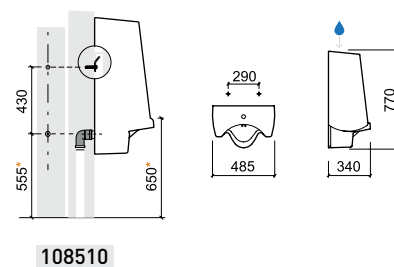

Urinois
Urinals
Urinoirs
Urinarios



FORMA

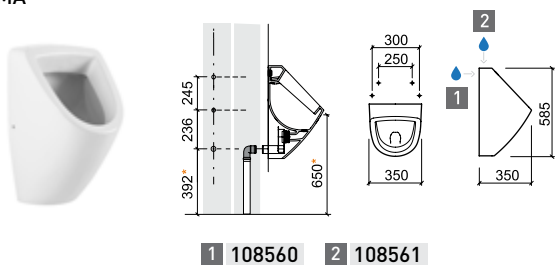

SANLIFE

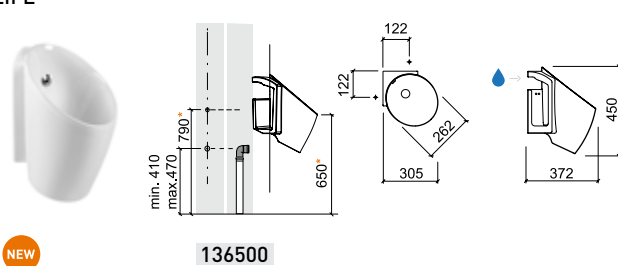



RIA

JADE *

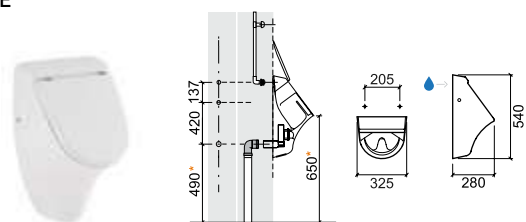

104500

RIA

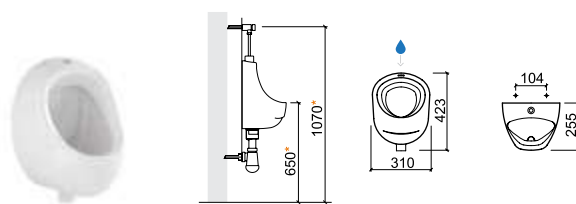

108500

pack
108590 
 + 108500
 + 10850030
 + 5190641
 + 10850000

Separadores
Dividers
Séparateurs
Separadores



LINK

LINK

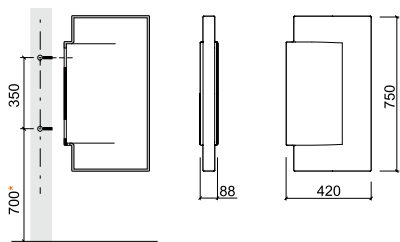

108540

WCKIDS

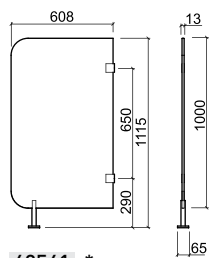

62541 *

Cores | Colours | Couleurs | Colores

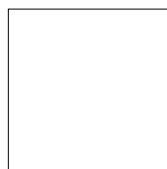

branco
white
blanc
blanco



* azul
blue
bleu
azul



* amarelo
yellow
jaune
amarillo

Sanita turca
Squat toilet
Wc turc
Placa turca

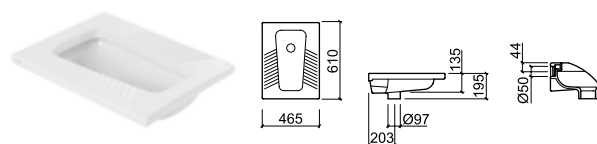

108610

Pia hospitalar
Slop hopper
Vidoir d'hôpital
Vertedero

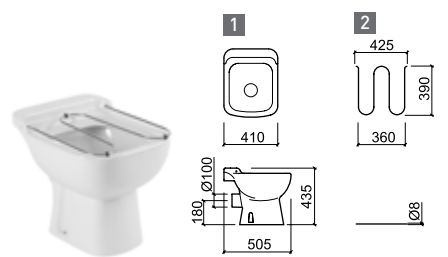

1 118610 2 4A1861

Lava-roupas
Laundry sinks
Bacs à laver
Lavaderos



BLINK

BLINK

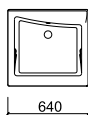

108640

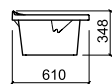

66006



Lava-roupas
Laundry sinks
Bacs à laver
Lavaderos



TRIBO



RIBA

TRIBO

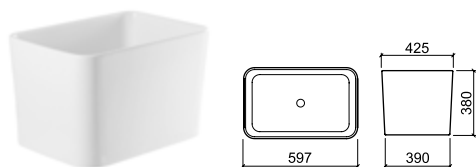

109900

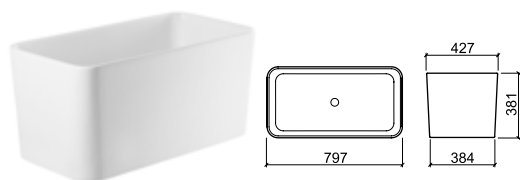

109910

RIBA

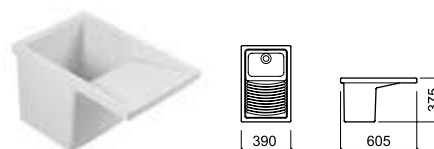

108600 66040

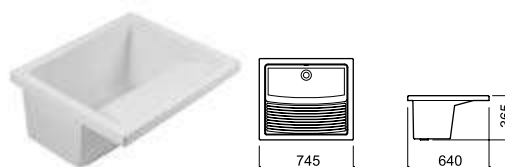

108630 66340





MOBILIDADE REDUZIDA
REDUCED MOBILITY
MOBILITÉ RÉDUITE
MOVILIDAD REDUCIDA



Louça sanitária
Sanitary ware
Appareils sanitaires
Sanitarios

- 232 New WcCare NEW
- 234 Proget Confort
- 235 Aveiro Confort
- 235 Aveiro

Acessórios
Accessories
Accessoires
Accesorios

- 236 New WcCare
- 240 WcCare

Base de duche e divisórias
Shower tray and shower enclosures
Receveur de douche et cabines de douche
Plato de ducha y mamparas de baño

- 243 New WcCare

Misturadoras
Mixers
Robinets
Grifos

- 244 Alfa
- 245 Easy
- 246 Eco



NEW WCCARE

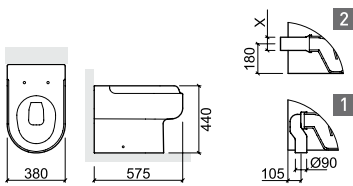

- 1 129011 22961 2295100A
- 2 129012 22931 2291100A
- 22951
- 22911

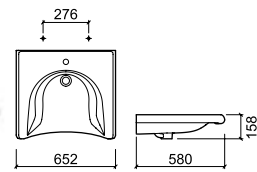

- 129320 1 42902

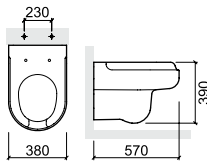

- 129032 22961 2295100A
- 22931 2291100A
- 22951
- 22911

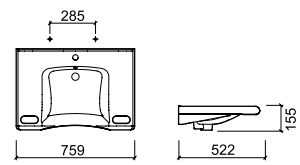

- 129330 1 42902

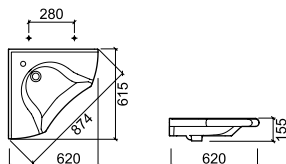

- 129700

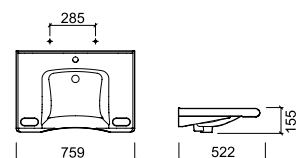

- 129337 1 42902

PROJET CONFORT

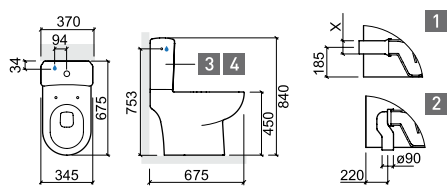

1 130021



3 130111LM

23031



21411



2 130022

4 130113LM



21411

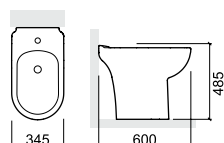

130410

21441



AVEIRO



AVEIRO CONFORT

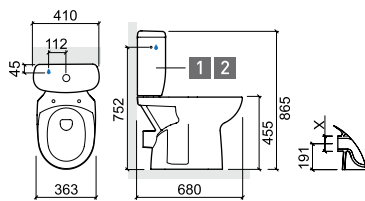

NF 103024

1 103111LM

2 103113LM

20331

20320

NF 20321

AVEIRO

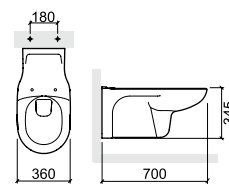

NF 103042

20331

20320

NF 20321

pack 103925
+ 20320



NEW WCCARE

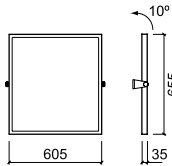

42969

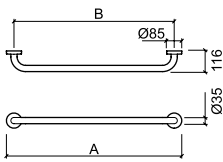

	A	B
1 42950	385	300
2 42951	535	450
3 42952	685	600
4 42970	785	700
5 42971	885	800
6 42953	985	900
7 42972	1085	1000

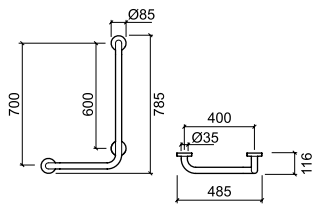

42960 **42961**

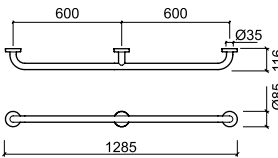

42966

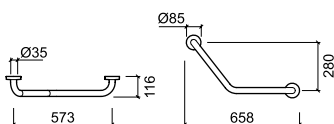

42954

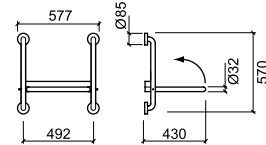

42948

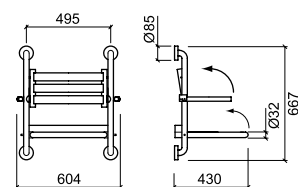

42946

NEW WCCARE

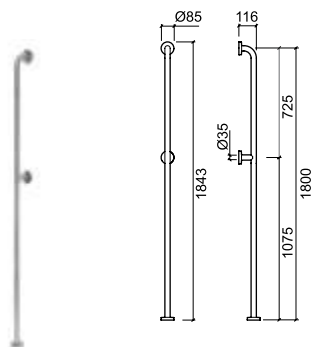

42967

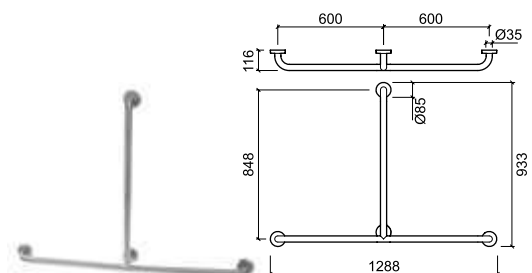

42965

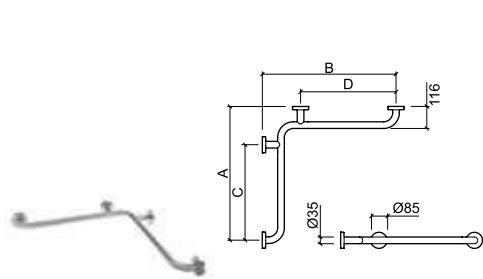

	A	B	C	D
1 42955	700	700	503	503
2 42956	800	800	603	603
3 42957	700	1000	503	803

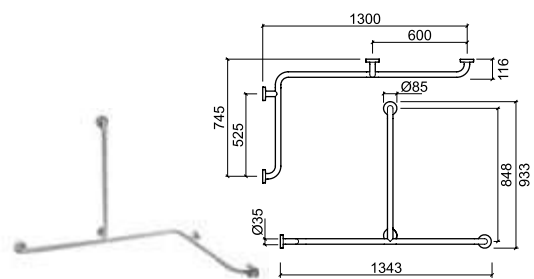

42959

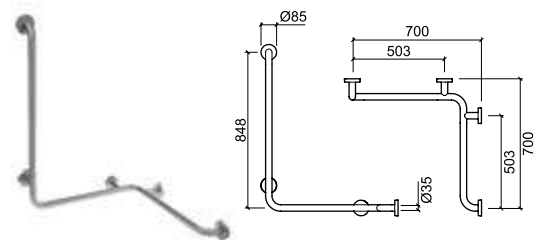

42958

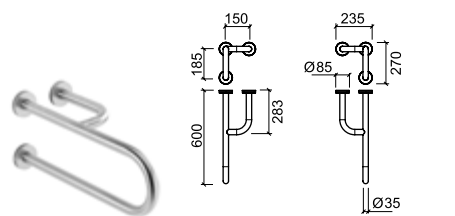

42973 42974

NEW WCCARE

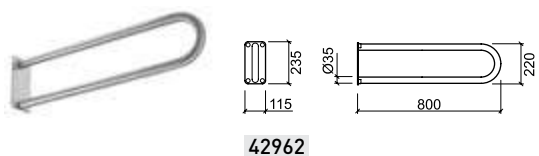

42962

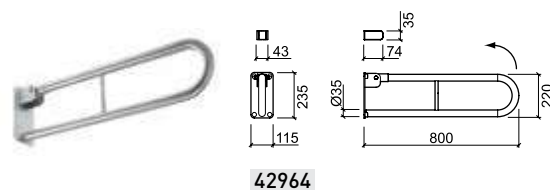

42964

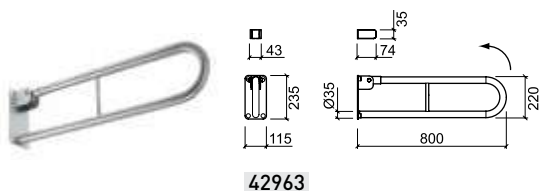

42963

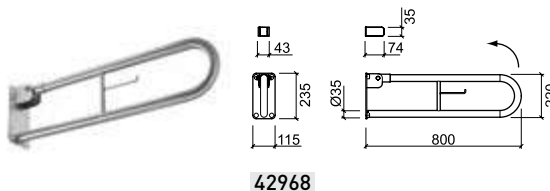

42968

WCCARE

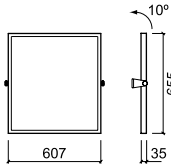

48069

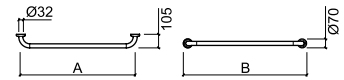

	A	B
1 48050	300	332
2 48051	450	482
3 48052	600	632
4 48053	900	932

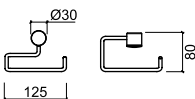

48010

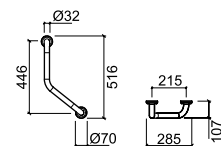

48054

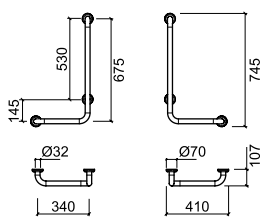

48056 **48057**

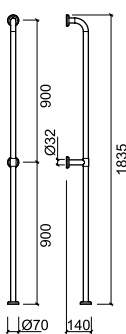

48067

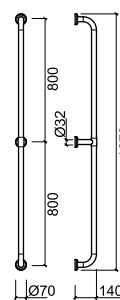

48068

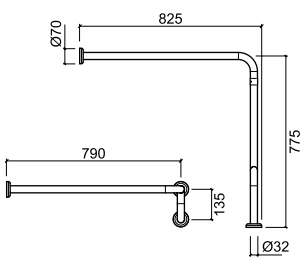

48065

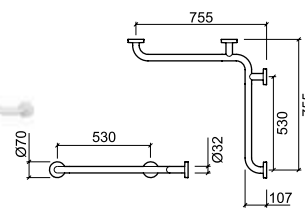

48055

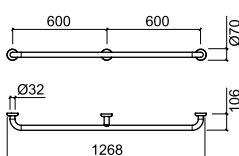

48066

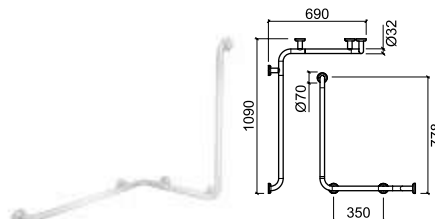

48058 **48059**

WCCARE

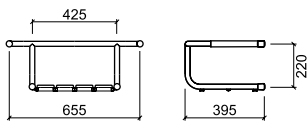

48047

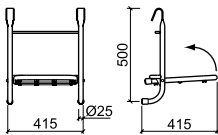

48049

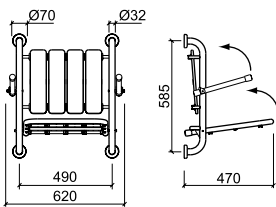

48046

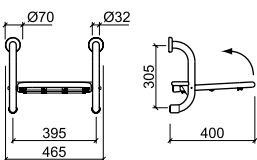

48048

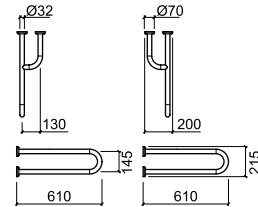

48060

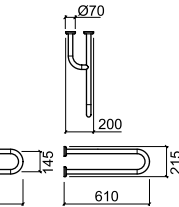

48061

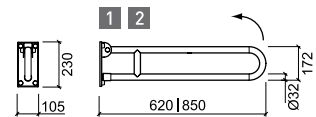

1 48062

2 48063

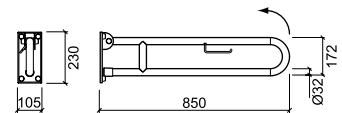

48064

NEW WCCARE

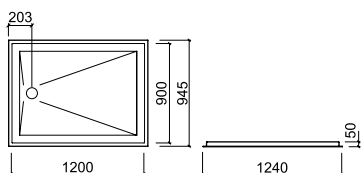

800900

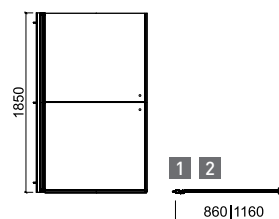
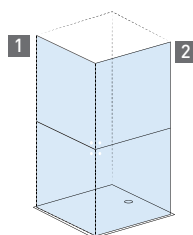

1 891920 2 891910



ALFA

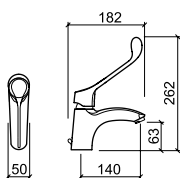

5008301

EASY

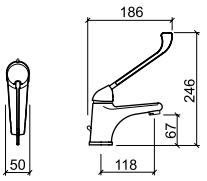

5368301

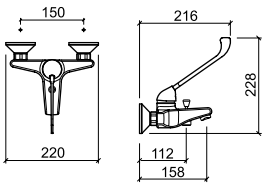

5366801

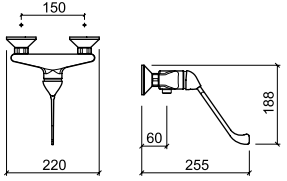

5365701





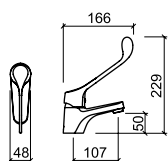

5198301

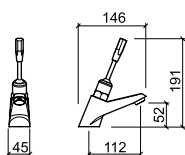

5198341

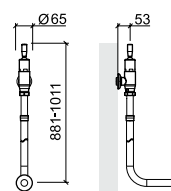

5196841

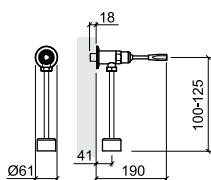

5195941

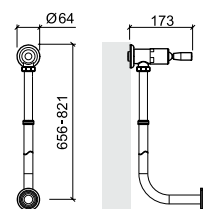

5192941

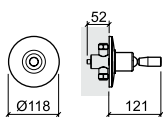

5195741

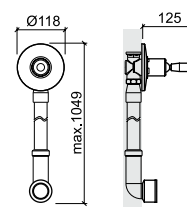

5194941





Louça sanitária
Sanitary ware
Appareils sanitaires
Sanitarios

251 Wc Kids

Móvel
Furniture
Meuble
Mueble

251 Wc Kids

Acessórios
Accessories
Accessoires
Accesorios

252 Wc Kids

Banheiras
Bathtubs
Baignoires
Bañeras

253 Babybath





WC KIDS

Cores | Colours | Couleurs | Colores

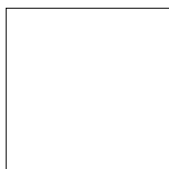

branco
white
blanc
blanco



*** azul**
blue
bleu
azul



*** amarelo**
yellow
jaune
amarillo

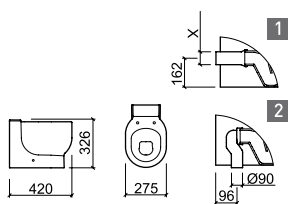

1 125011 22511 *
2 125012

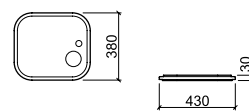

62570 *

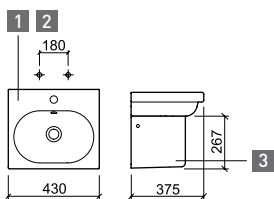

1 125300
2 125310 42501 42513
3 125220

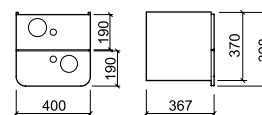

62531 125300
125310

WC KIDS

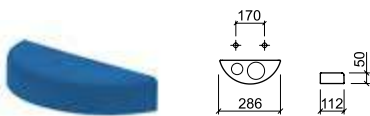

42501 *

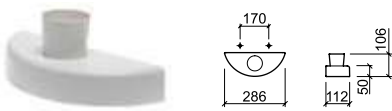

42513 *

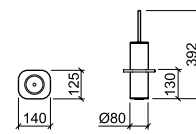

42521 *

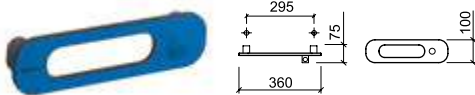

42526 *

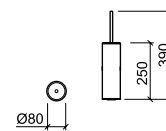

42509

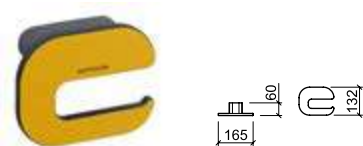

42510 *

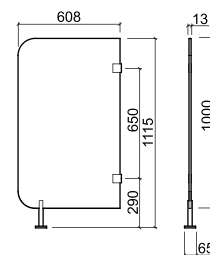

62541 *

BABYBATH

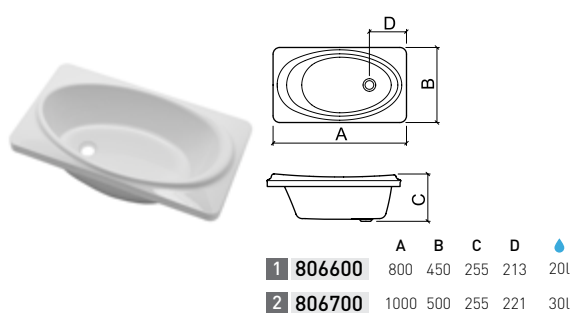





**BANHEIRAS
BATHTUBS
BAIGNOIRES
BAÑERAS**

Coleções

Collections

Collections

Colecciones

- 256 Urb.Y Plus
- 257 Millennium
- 258 WCA
- 259 Plan
- 260 Vintage
- 261 Urb.Y
- 262 Vértice
- 264 Eva
- 265 Aveiro
- 266 Easy
- 267 Rimini
- 268 Alfa
- 269 Agres
- 270 Rita
- 271 Delta
- 272 Duna
- 273 Skin
- 274 Shortline
- 275 Twospace
- 276 **Acessórios**
Accessories
Accessoires
Accesorios
- 277 **Bathmoments**



URB.Y PLUS



804600

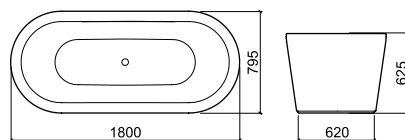

225L

MILLENNIUM



804200



491



X90

824201



824202



TOP

844201



844202

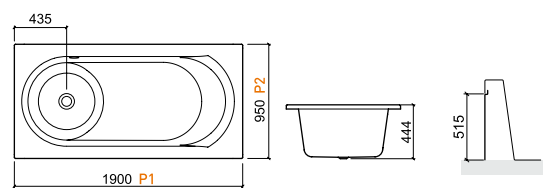

302L P1 P2
803701 804202

WCA



1 804500 490



1 824501 824502

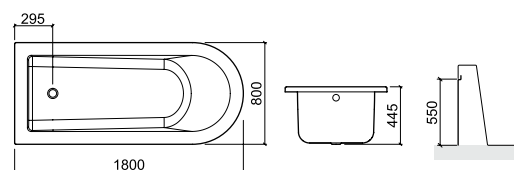

237L 804505

X90

PLAN



1	803600	491
2	803300	491
3	807300	491



X90

1	823601	823602
2	823301	823302
3	827301	827302



TOP

2	843301	843302
---	--------	--------

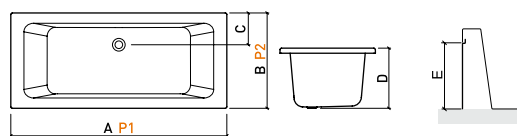

	A	B	C	D	E	Water	P1	P2
1	1700	750	250	480	590	237L	803601	803602
2	1800	800	235	500	590	293L	803301	803302
3	1900	900	280	560	655	420L	807301	807302

VINTAGE



803400 490



X90

823401 823402



TOP

843401 843402

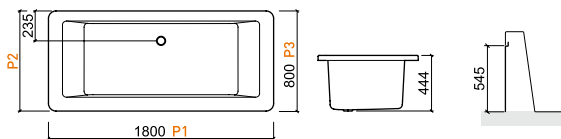

205L P1 P2 P3
 803401 803403 803402

URB.Y



1	807600	490
2	807700	490
3	807800	490



1	827601	827602
2	827701	827702
3	827801	827802

X90

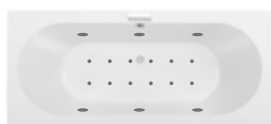

2	847701	847702
3	847801	847802

TOP

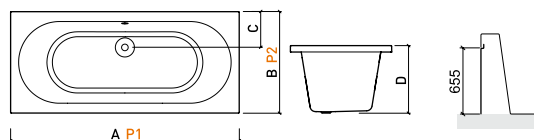

	A	B	C	D	Water Drop	P1	P2
1	1695	745	280	530	235L	807601	807602
2	1795	795	288	525	275L	807701	807702
3	1895	895	280	530	360L	807801	807802

VÉRTICE



1	807500	490
2	805600	490
3	805700	490
4	805800	490
5	805900	490
6	806000	490
7	806100	490
8	806200	490

X90



1	827501	827502
2	825601	825602
3	825701	825702
4	825801	825802
5	825901	825902
6	826001	826002
7	826101	826102
8	826201	826202

TOP



7	846101	846102
8	846201	846202

VÉRTICE

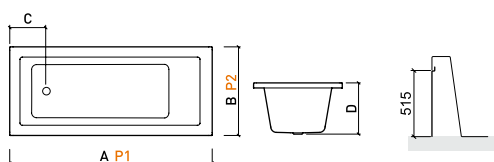

	A	B	C	D	Water	P1	P2
1	1501	700	291	385	140L	800601	800203
2	1600	700	290	405	160L	805601	800203
3	1600	750	290	405	180L	805601	800202
4	1700	700	290	405	175L	805801	800203
5	1700	750	295	405	190L	805801	800202
6	1750	800	298	405	210L	806001	800302
7	1800	800	301	405	215L	805101	800302
8	1900	900	304	405	280L	806201	806202

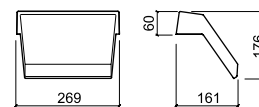

8056

EVA



1	800600	490
2	800100	490
3	803500	490



1	820601	820602
2	820101	820102
3	823501	823502

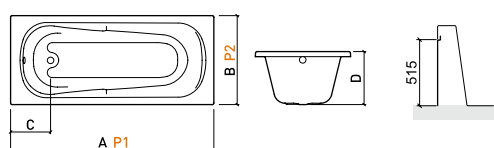

	A	B	C	D	Water Capacity	P1	P2
1	1500	700	300	420	144L	800601	800203
2	1600	700	300	420	157L	800101	800203
3	1600	750	300	420	160L	800101	800202

X90

AVEIRO

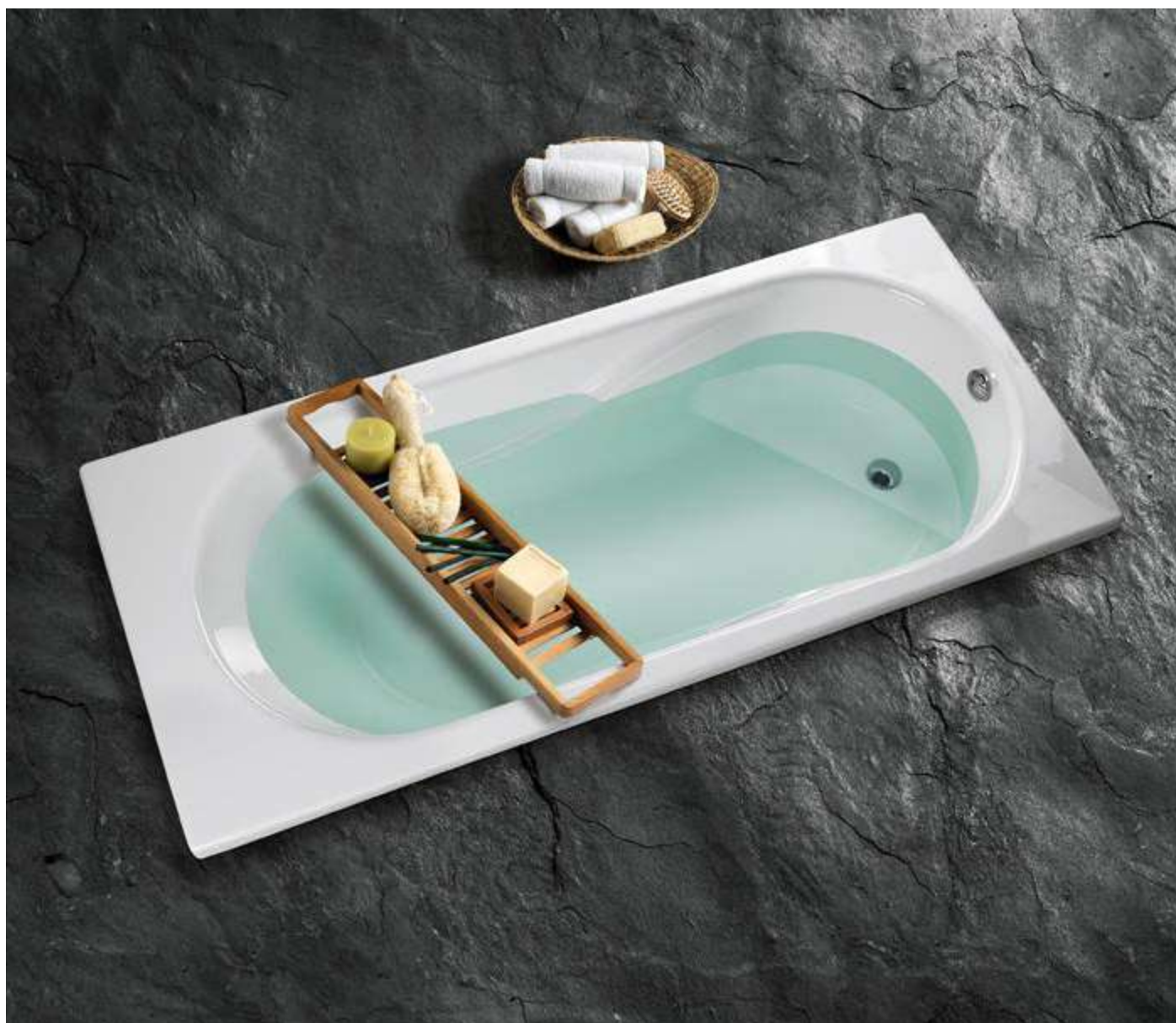

1	803000	490
2	803200	490
3	803100	490



EASY

1	8E3001	8E3002
2	8E3201	8E3202
3	8E3101	8E3102



X90

1	823001	823002
2	823201	823202
3	823101	823102

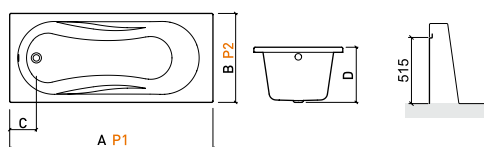

	A	B	C	D	Water	P1	P2
1	1600	700	200	416	160L	800101	800203
2	1700	700	245	415	170L	800201	800203
3	1700	750	200	425	182L	800201	800202

EASY



1 806800 490
2 806900 490



1 826801 826802
2 826901 826902

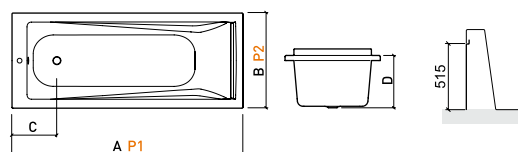

	A	B	C	D	Water	P1	P2
1	1700	700	330	413	155L	805801	800203
2	1700	750	322	416	170L	805801	800202

X90

RIMINI



801400  490

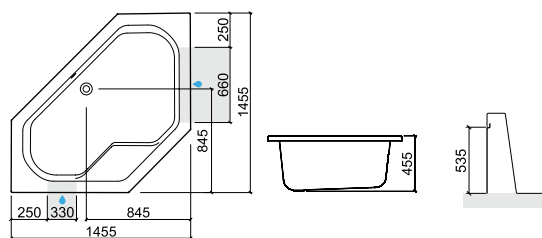

 310L  801403

ALFA



801100



490



X90

821101



821102



TOP

841101



841102

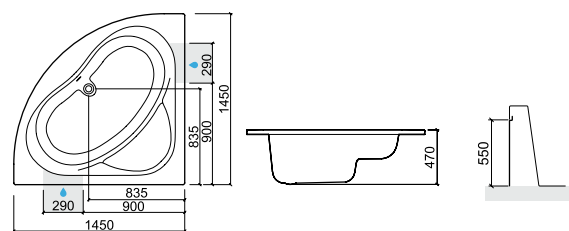

277L



801104

AGRES



807400 490



X90

827401 827402



TOP

847401 847402

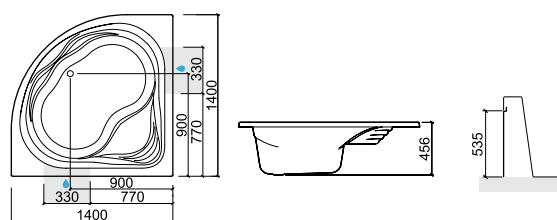

280L 807403



RITA



801000



490



X90

821001



821002



TOP

841001



841002

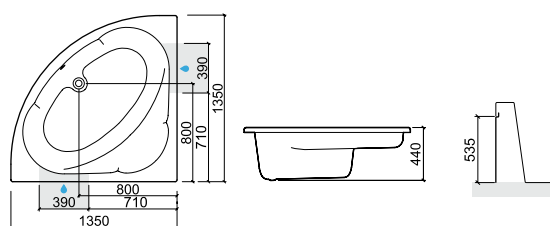

210L



801003

DELTA



 **801500**  **801600**  **490**

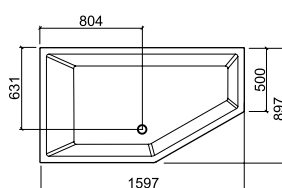

 325L



DUNA



 802100
  802200
  491





X90

 822101
  822201



TOP

 842101
  842201

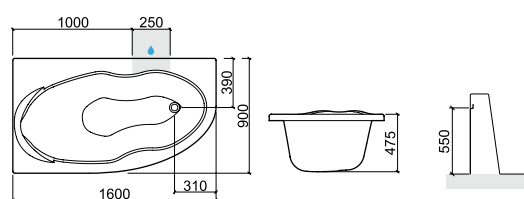

 170L
  802101

SKIN



801200 490



821201 821202

X90

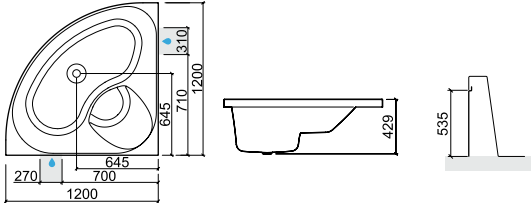

173L 801203





SHORTLINE

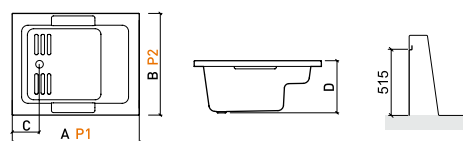

		
1	806300	490
2	806400	490
3	806500	490



	A	B	C	D			P2
1	1000	700	220	410	90L	806301	800203
2	1000	750	215	410	100L	806301	800202
3	1000	800	215	410	120L	806301	800302

TWOSPACE



- 805200  486
- 8652031100
- 8652031100A 1 P1
- 8652031100B 1 P1 + 1 P2
- 8652031100E 1 P1 + 2 P2
- 8652031100G 2 P1 + 1 P2
- 8652031100F 2 P1 + 2 P2

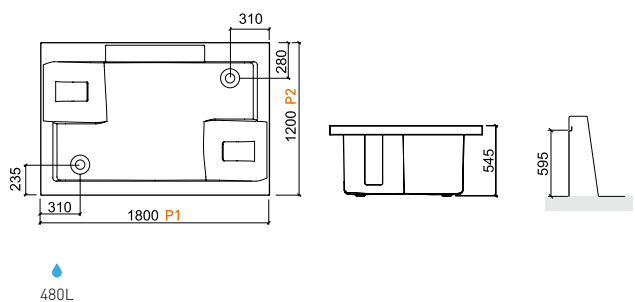

Acessórios
 Accessories
 Accessoires
 Accesorios

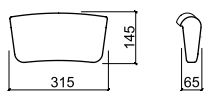

8005

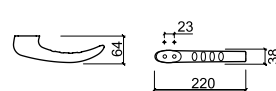

8001

TWOSPACE

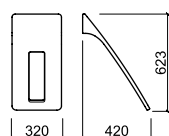

8052

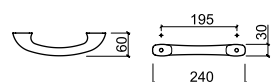

8002

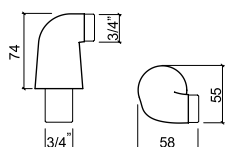

5A00070

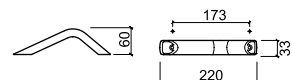

8012

BATHMOMENTS



4000000

ENERGY

PASSION



4000200



4000400

RELAX

FRESH



4000700



4000800





BASES DE DUCHE
SHOWER TRAYS
RECEVEURS DE DOUCHE
PLATOS DE DUCHA

Stonit

- 280 Marina Plus 
- 284 Marina

Cerâmicas

- Ceramic
- Céramiques
- Cerámicos

- 288 Moraira Plus 
- 290 Waterline 
- 292 Stepln
- 296 Moraira
- 299 Time

Acrílicas

- Acrylic
- Acryliques
- Acrílicos

- 300 Piano
- 304 Mosaico
- 305 Elsy
- 306 Strado
- 308 Open
- 310 WCA
- 311 Mosaico
- 312 Strado
- 314 Piano
- 318 Millennium
- 319 Face
- 320 Open

Calha de duche

- Shower channel
- Caniveaux de douche
- Canal de ducha

- 322 Metric



MARINA PLUS



NEW

STONIT



CLASSE 3
CLASS
CLASSE



Cores | Colours | Couleurs | Colores



branco
white
blanc
blanco



cinza
grey
gris
gris



bege
beige
beije
beige

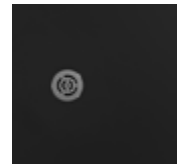

preto
black
noir
negro

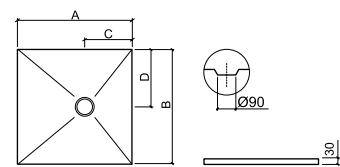

NEW

CLASSE 3
CLASS
CLASSE

	A	B	C	D	
96070070	700	700	250	350	70x70
96080080	800	800	250	400	80x80
96090090	900	900	250	450	90x90
96100100	1000	1000	250	500	100x100
96110110	1100	1100	250	550	110x110
96120120	1200	1200	250	600	120x120



MARINA PLUS

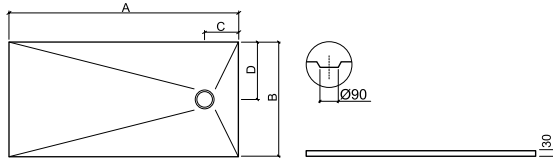

CLASSE CLASS CLASS CLASS 3

96080070 A B C D 800 700 250 350 80x70

96090070 900 700 250 350 90x70

96090080 900 800 250 400 90x80

96100070 1000 700 250 350 100x70

96100080 1000 800 250 400 100x80

96100090 1000 900 250 450 100x90

96110070 1100 700 250 350 110x70

96110080 1100 800 250 400 110x80

96110090 1100 900 250 450 110x90

96110100 1100 1000 250 500 110x100

96120070 1200 700 250 350 120x70

96120080 1200 800 250 400 120x80

96120090 1200 900 250 450 120x90

96120100 1200 1000 250 500 120x100

96120110 1200 1100 250 550 120x110

96130070 1300 700 450 350 130x70

96130080 1300 800 450 400 130x80

96130090 1300 900 450 450 130x90

96130100 1300 1000 450 500 130x100

96130110 1300 1100 450 550 130x110

96130120 1300 1200 450 600 130x120

96140070 1400 700 450 350 140x70

96140080 1400 800 450 400 140x80

96140090 1400 900 450 450 140x90

96140100 1400 1000 450 500 140x100

96140110 1400 1100 450 550 140x110

96140120 1400 1200 450 600 140x120

96150070 1500 700 450 350 150x70

96150080 1500 800 450 400 150x80

96150090 1500 900 450 450 150x90

96150100 1500 1000 450 500 150x100

96150110 1500 1100 450 550 150x110

96150120 1500 1200 450 600 150x120

96160070 A B C D 1600 700 450 350 160x70

96160080 1600 800 450 400 160x80

96160090 1600 900 450 450 160x90

96160100 1600 1000 450 500 160x100

96160110 1600 1100 450 550 160x110

96160120 1600 1200 450 600 160x120

96170070 1700 700 450 350 170x70

96170080 1700 800 450 400 170x80

96170090 1700 900 450 450 170x90

96170100 1700 1000 450 500 170x100

96170110 1700 1100 450 550 170x110

96170120 1700 1200 450 600 170x120

96180070 1800 700 450 350 180x70

96180080 1800 800 450 400 180x80

96180090 1800 900 450 450 180x90

96180100 1800 1000 450 500 180x100

96180110 1800 1100 450 550 180x110

96180120 1800 1200 450 600 180x120

96190070 1900 700 450 350 190x70

96190080 1900 800 450 400 190x80

96190090 1900 900 450 450 190x90

96190100 1900 1000 450 500 190x100

96190110 1900 1100 450 550 190x110

96190120 1900 1200 450 600 190x120

96200070 2000 700 450 350 200x70

96200080 2000 800 450 400 200x80

96200090 2000 900 450 450 200x90

96200100 2000 1000 450 500 200x100

96200110 2000 1100 450 550 200x110

96200120 2000 1200 450 600 200x120

96210070 2100 700 450 350 210x70

96210080 2100 800 450 400 210x80

96210090 2100 900 450 450 210x90

96210100 2100 1000 450 500 210x100

96210110 2100 1100 450 550 210x110

96210120 2100 1200 450 600 210x120

96220070 A B C D 2200 700 450 350 220x70

96220080 2200 800 450 400 220x80

96220090 2200 900 450 450 220x90

96220100 2200 1000 450 500 220x100

96220110 2200 1100 450 550 220x110

96220120 2200 1200 450 600 220x120

96230070 2300 700 450 350 230x70

96230080 2300 800 450 400 230x80

96230090 2300 900 450 450 230x90

96230100 2300 1000 450 500 230x100

96230110 2300 1100 450 550 230x110

96230120 2300 1200 450 600 230x120

96240070 2400 700 450 350 240x70

96240080 2400 800 450 400 240x80

96240090 2400 900 450 450 240x90

96240100 2400 1000 450 500 240x100

96240110 2400 1100 450 550 240x110

96240120 2400 1200 450 600 240x120

96250070 2500 700 450 350 250x70

96250080 2500 800 450 400 250x80

96250090 2500 900 450 450 250x90

96250100 2500 1000 450 500 250x100

96250110 2500 1100 450 550 250x110

96250120 2500 1200 450 600 250x120

96260070 2600 700 450 350 260x70

96260080 2600 800 450 400 260x80

96260090 2600 900 450 450 260x90

96260100 2600 1000 450 500 260x100

96260110 2600 1100 450 550 260x110

96260120 2600 1200 450 600 260x120



MARINA



Cores | Colours | Couleurs | Colores



*** branco**
white
blanc
blanco



*** cinza**
grey
gris
gris



*** bege**
beige
beije
beige

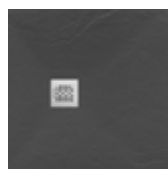

*** preto**
black
noir
negro



*** xisto**
schist
schiste
pizarra

STONIT



CLASSE
CLASS
CLASE

3





MARINA

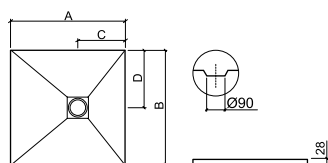

3

	A	B	C	D	
95070070	700	700	350	350	70x70
95080080	800	800	350	400	80x80
95090090	900	900	350	450	90x90
95100100	1000	1000	350	500	100x100
95110110	1100	1100	450	550	110x110
95120120	1200	1200	450	600	120x120

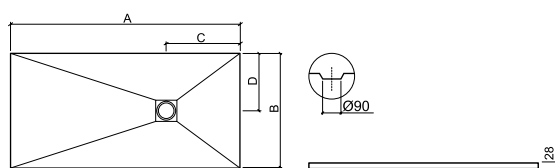

3

	A	B	C	D	
95080070	800	700	350	350	80x70
95090070	900	700	350	350	90x70
95090080	900	800	350	400	90x80
95100070	1000	700	350	350	100x70
95100080	1000	800	350	400	100x80
95100090	1000	900	350	450	100x90
95110070	1100	700	450	350	110x70
95110080	1100	800	450	400	110x80
95110090	1100	900	450	450	110x90
95110100	1100	1000	450	500	110x100
95120070	1200	700	450	350	120x70
95120080	1200	800	450	400	120x80
95120090	1200	900	450	450	120x90
95120100	1200	1000	450	500	120x100
95120110	1200	1100	450	550	120x110
95130070	1300	700	450	350	130x70
95130080	1300	800	450	400	130x80
95130090	1300	900	450	450	130x90
95130100	1300	1000	450	500	130x100
95130110	1300	1100	450	550	130x110
95130120	1300	1200	450	600	130x120

	A	B	C	D	
95140070	1400	700	450	350	140x70
95140080	1400	800	450	400	140x80
95140090	1400	900	450	450	140x90
95140100	1400	1000	450	500	140x100
95140110	1400	1100	450	550	140x110
95140120	1400	1200	450	600	140x120
95150070	1500	700	450	350	150x70
95150080	1500	800	450	400	150x80
95150090	1500	900	450	450	150x90
95150100	1500	1000	450	500	150x100
95150110	1500	1100	450	550	150x110
95150120	1500	1200	450	600	150x120
95160070	1600	700	450	350	160x70
95160080	1600	800	450	400	160x80
95160090	1600	900	450	450	160x90
95160100	1600	1000	450	500	160x100
95160110	1600	1100	450	550	160x110
95160120	1600	1200	450	600	160x120
95170070	1700	700	450	350	170x70
95170080	1700	800	450	400	170x80
95170090	1700	900	450	450	170x90
95170100	1700	1000	450	500	170x100
95170110	1700	1100	450	550	170x110
95170120	1700	1200	450	600	170x120

	A	B	C	D	
95180070	1800	700	450	350	180x70
95180080	1800	800	450	400	180x80
95180090	1800	900	450	450	180x90
95180100	1800	1000	450	500	180x100
95180110	1800	1100	450	550	180x110
95180120	1800	1200	450	600	180x120
95190070	1900	700	450	350	190x70
95190080	1900	800	450	400	190x80
95190090	1900	900	450	450	190x90
95190100	1900	1000	450	500	190x100
95190110	1900	1100	450	550	190x110
95190120	1900	1200	450	600	190x120
95200070	2000	700	450	350	200x70
95200080	2000	800	450	400	200x80
95200090	2000	900	450	450	200x90
95200100	2000	1000	450	500	200x100
95200110	2000	1100	450	550	200x110
95200120	2000	1200	450	600	200x120
95210070	2100	700	450	350	210x70
95210080	2100	800	450	400	210x80
95210090	2100	900	450	450	210x90
95210100	2100	1000	450	500	210x100
95210110	2100	1100	450	550	210x110
95210120	2100	1200	450	600	210x120



MORAIRA PLUS



NEW

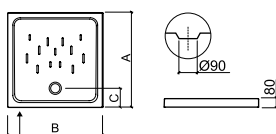

	A	B	C	
107790	792	795	180	80x80
107800	903	900	180	90x90

NEW 487

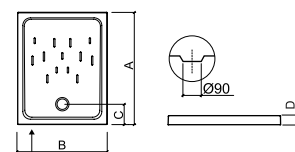

	A	B	C	D	
107812	995	795	180	80	100x80
107822	1190	795	180	80	120x80
107832	1195	895	180	81	120x90

NEW 487

WATERLINE

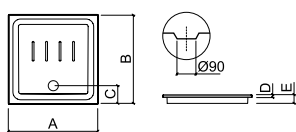

 487

	A	B	C	D	E	
107480	800	800	164	20	80	80x80
107500	895	895	180	18	73	90x90

WATERLINE

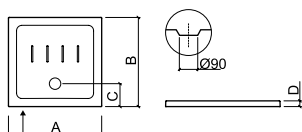

487

	A	B	C	D	
107470	800	800	180	50	80x80
107780	898	898	220	45	90x90

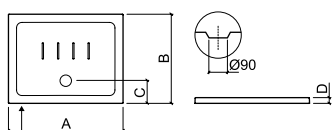

487

	A	B	C	D	
107722	992	795	220	45	100x80
NEW 107732	995	895	220	45	100x90
107742	1198	796	220	45	120x80
NEW 107752	1195	895	220	45	120x90

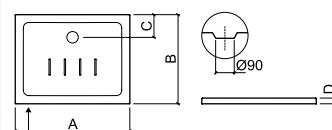

487

	A	B	C	D	
107442	905	708	184	45	90x70
107452	1010	706	185	45	100x70
107462	1200	700	180	45	120x70
107512	1390	698	177	47	140x70



STEPIN

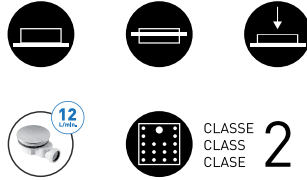

CLASSE
CLASS
CLASE

2



Cores | Colours | Couleurs | Colores

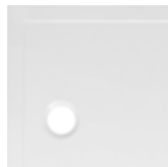

branco
white
blanc
blanco



branco
white
blanc
blanco



preto
black
noir
negro



cinza
grey
gris
gris





STEPIN

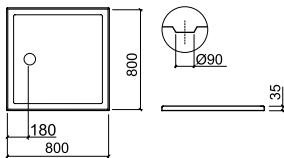

487

NF 107520 80x80

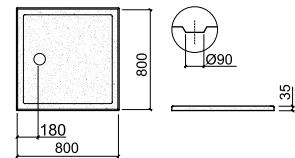

CLASSE CLASS CLASS 2 487

107520AD 80x80

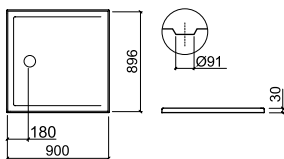

487

NF 107530 90x90

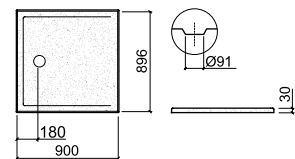

CLASSE CLASS CLASS 2 487

107530AD 90x90

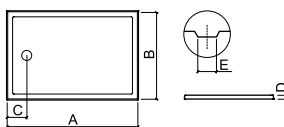
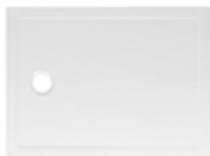

487

	A	B	C	D	E	
NF 107562	1000	700	180	30	ø91	100x70
NF 107542	990	790	180	30	ø90	100x80
107572	1200	700	180	30	ø91	120x70

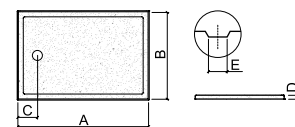
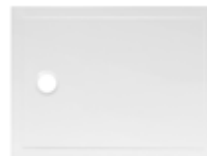

CLASSE CLASS CLASS 2 487

	A	B	C	D	E	
107562AD	1000	700	180	30	ø91	100x70
107542AD	990	790	180	30	ø90	100x80
107572AD	1200	700	180	30	ø91	120x70

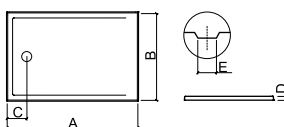
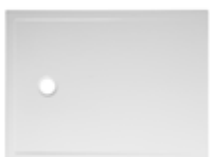

487

	A	B	C	D	E	
NF 107552	1195	795	180	30	ø90	120x80
NF 107612	1194	895	250	33	ø91	120x90
107622	1397	693	250	33	ø91	140x70
107632	1398	790	250	30	ø90	140x80
107642	1395	891	250	33	ø91	140x90

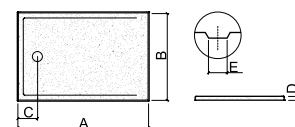

CLASSE CLASS CLASS 2 487

	A	B	C	D	E	
107552AD	1195	795	180	30	ø90	120x80
107612AD	1194	895	250	33	ø91	120x90
107622AD	1397	693	250	33	ø91	140x70
107632AD	1398	790	250	30	ø90	140x80
107642AD	1395	891	250	33	ø91	140x90

MORAIRA

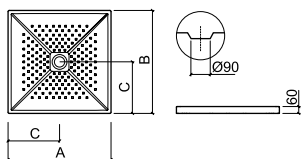

487



107245

A	B	C	
800	800	400	80x80



107255

900	900	450	90x90
-----	-----	-----	-------

MORAIRA



495

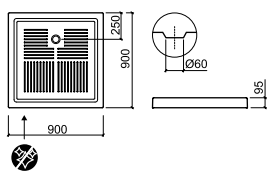

NF 107250 90x90



495

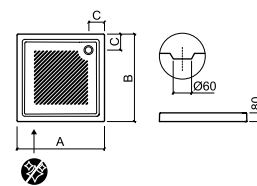

	A	B	C	
NF 107150	700	700	150	70x70
107160	750	750	145	75x75
NF 107170	800	800	150	80x80



495

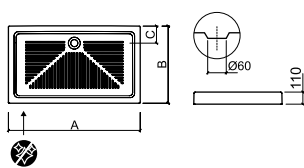

	A	B	C	
107182	900	720	250	90x72
107192	1000	700	155	100x70
107202	1208	707	162	120x70
107212	1200	800	250	120x80

MORAIRA

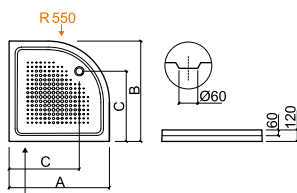

495

	A	B	C	
107221	800	800	530	80x80
107231	900	900	630	90x90

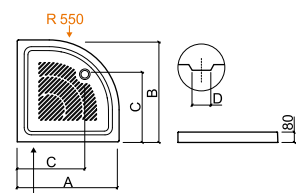

495

	A	B	C	D	
107161	750	750	490	ø62	75x75
107171	800	800	530	ø60	80x80

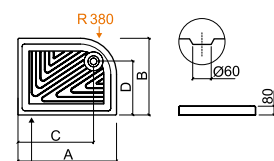

495

	A	B	C	D	
107261	900	700	670	470	75x75
107271	900	700	670	470	80x80

TIME

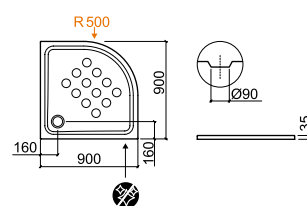

487

107361 90x90



PIANO



487

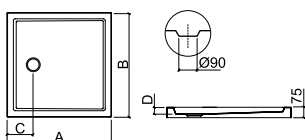

	A	B	C	D	
803550	800	800	200	46	80x80
803560	900	900	200	46	90x90
803570	997	1000	200	48	100x100

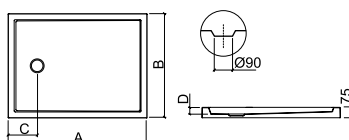

	A	B	C	D	
802360	1000	700	250	50	100x70
802370	1000	750	250	47	100x75
802380	998	803	250	48	100x80
802390	1000	902	250	46	100x90

802410	1198	702	253	47	120x70
802420	1200	753	252	46	120x75
802430	1200	800	250	48	120x80
802440	1203	903	251	48	120x90

802450	1300	701	250	46	130x70
802460	1302	752	251	46	130x75
802470	1300	801	250	46	130x80
802480	1300	900	253	48	130x90

802490	1400	700	250	46	140x70
802510	1400	750	250	50	140x75
802520	1396	803	250	48	140x80
802530	1400	900	250	50	140x90

	A	B	C	D	
802540	1498	700	250	46	150x70
802550	1500	752	250	46	150x75
802560	1500	801	250	46	150x80
802570	1500	900	250	46	150x90

802580	1600	700	250	60	160x70
802590	1602	755	250	53	160x75
802610	1600	803	252	57	160x80
802620	1600	900	250	55	160x90

803450	1700	703	250	44	170x70
803460	1698	751	250	55	170x75

802630	1798	700	250	60	180x70
802640	1800	750	250	60	180x75
802650	1804	804	252	62	180x80
802660	1800	900	250	65	180x90

802670	2000	700	250	65	200x70
802690	2000	800	250	60	200x75
802710	2003	903	253	60	200x80

PIANO



487

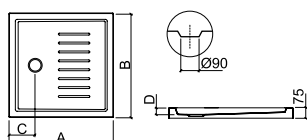

	A	B	C	D	
803620	800	800	200	46	80x80
803630	900	900	200	46	90x90
803640	997	1000	200	48	100x100

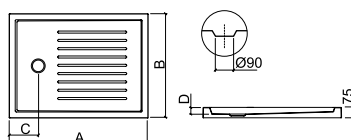

	A	B	C	D	
803070	1000	700	250	50	100x70
803080	1000	750	250	47	100x75
803090	998	803	250	48	100x80
803110	1000	902	250	46	100x90

803120	1198	702	253	47	120x70
803130	1200	753	252	46	120x75
803140	1200	800	250	48	120x80
803150	1203	903	251	48	120x90

803160	1300	701	250	46	130x70
803170	1302	752	251	46	130x75
803180	1300	801	250	46	130x80
803190	1300	900	253	48	130x90

803210	1400	700	250	46	140x70
803220	1400	750	250	50	140x75
803230	1396	803	250	48	140x80
803240	1400	899	250	50	140x90

	A	B	C	D	
803250	1498	700	250	46	150x70
803260	1500	752	250	46	150x75
803270	1500	801	250	46	150x80
803280	1500	900	250	46	150x90

803290	1600	700	250	60	160x70
803310	1602	755	250	53	160x75
803320	1600	803	252	57	160x80
803330	1600	900	250	55	160x90

803490	1700	703	250	44	170x70
803510	1698	751	250	55	170x75

803340	1798	700	250	60	180x70
803350	1800	750	250	60	180x75
803360	1804	804	252	62	180x80
803370	1800	900	250	65	180x90

803380	2000	700	250	65	200x70
803410	2000	800	250	60	200x75
803420	2003	903	253	60	200x80



MOSAICO



 **487**

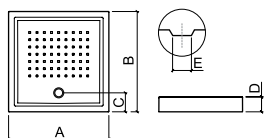

	A	B	C	D	E	
800230	700	700	170	80	ø90	70x70

800260	750	750	170	80	ø90	75x75
---------------	-----	-----	-----	----	-----	-------



 **495**

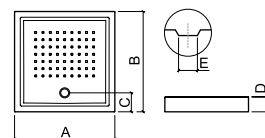

	A	B	C	D	E	
800430	700	700	170	120	ø62	70x70

800420	700	700	170	160	ø62	70x70
---------------	-----	-----	-----	-----	-----	-------

800450	750	750	170	120	ø62	75x75
---------------	-----	-----	-----	-----	-----	-------

800440	750	750	170	160	ø62	75x75
---------------	-----	-----	-----	-----	-----	-------

ELSY

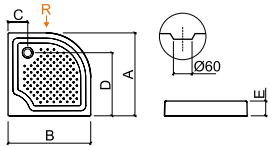

 495

	A	B	C	D	E	R	
800030	750	745	200	550	130	370	75x75
800040	800	795	200	600	130	475	80x80
800050	900	893	200	700	135	480	90x90



STRADO



 487

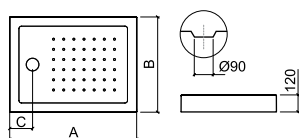

	A	B	C	
800910	1001	750	181	100x75
800930	1001	801	181	100x80
800950	1001	901	181	100x90



 487

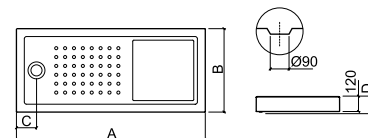

	A	B	C	D	
800720	1200	750	175	125	120x75
800810	1200	800	180	125	120x80
800850	1200	900	180	124	120x90
800730	1400	750	175	125	140x75
800820	1400	800	180	128	140x80
800860	1400	900	180	128	140x90
800740	1600	750	175	130	160x75
800830	1600	800	180	132	160x80
800870	1600	900	180	132	160x90
800750	1700	750	180	130	170x75
800840	1700	800	180	134	170x80
800880	1700	900	180	134	170x90



OPEN

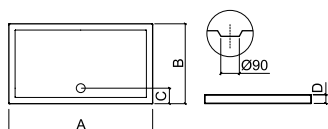

 487

	A	B	C	D	
801210	1000	700	180	75	100x70
801240	1000	750	175	75	100x75
801270	1000	800	175	75	100x80
801310	1000	900	175	75	100x90
801220	1200	700	180	75	120x70
801250	1200	755	175	75	120x75
801280	1206	806	175	75	120x80
801320	1200	900	175	75	120x90
801230	1400	700	175	75	140x70
801260	1400	750	180	75	140x75
801290	1400	800	180	70	140x80
801330	1400	900	175	75	140x90

	A	B	C	D	
801590	1500	700	177	75	150x70
801630	1600	700	175	75	160x70
801640	1600	750	177	75	160x75
801650	1600	800	176	75	160x80
801660	1600	900	176	75	160x90
801670	1703	701	176	75	170x70
801680	1700	750	176	75	170x75
801690	1700	800	176	75	170x80
801720	1800	750	176	75	180x75
801730	1800	800	176	75	180x80

WCA

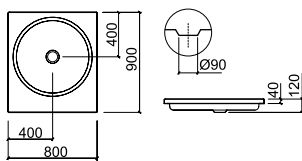

487

800140 90x80

MOSAICO

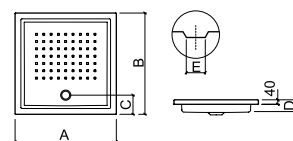

 495

	A	B	C	D	E	
800220	700	700	170	91	ø62	70x70
800210	700	700	170	120	ø60	70x70
800250	750	750	170	92	ø62	75x75
800240	750	750	170	132	ø62	75x75



STRADO



 487

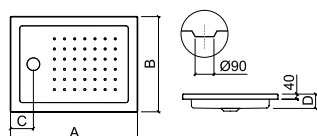

	A	B	C	D	
800890	1001	750	181	94	100x75
800920	1001	801	181	94	100x80
800940	1001	901	181	94	100x90



 487

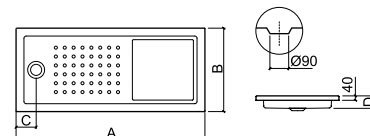

	A	B	C	D	
800370	1200	750	175	95	120x75
800670	1200	800	180	98	120x80
800760	1200	900	180	98	120x90
800380	1400	750	180	100	140x75
800680	1400	800	180	103	140x80
800770	1400	900	180	103	140x90
800390	1600	750	175	100	160x75
800690	1600	800	180	107	160x80
800780	1600	900	180	107	160x90
800410	1700	750	180	105	170x75
800710	1700	800	180	109	170x80
800790	1700	900	180	109	170x90



PIANO

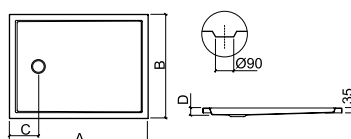
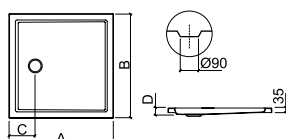

 487

	A	B	C	D	
803520	800	800	200	46	80x80
803530	900	900	200	46	90x90
803540	997	1000	200	48	100x100

	A	B	C	D	
802010	1000	700	250	50	100x70
802020	1000	750	250	47	100x75
802030	998	803	250	48	100x80
802040	1000	902	250	46	100x90

	A	B	C	D	
802180	1498	700	250	46	150x70
802190	1500	752	250	46	150x75
802210	1500	801	250	46	150x80
802220	1500	900	250	46	150x90

802050	1200	702	250	48	120x70
802060	1200	751	250	50	120x75
802070	1200	800	250	47	120x80
802080	1203	903	251	48	120x90

802230	1600	700	250	60	160x70
802240	1602	755	250	53	160x75
802250	1600	803	252	57	160x80
802260	1600	900	250	55	160x90

802090	1300	701	250	46	130x70
802110	1301	751	250	46	130x75
802120	1300	801	250	46	130x80
802130	1300	900	253	48	130x90

803430	1700	703	250	44	170x70
803440	1698	751	250	55	170x75

802140	1400	700	250	46	140x70
802150	1400	750	250	50	140x75
802160	1396	803	250	48	140x80
802170	1400	899	250	50	140x90

802270	1798	700	250	60	180x70
802280	1800	750	250	60	180x75
802290	1804	804	252	62	180x80
802310	1800	900	250	65	180x90

802320	2000	700	250	65	200x70
802340	2000	800	250	60	200x80
802350	2003	903	253	60	200x90

PIANO



487

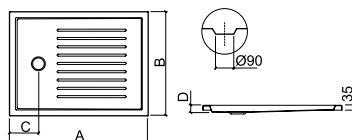
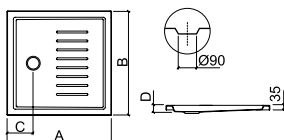

	A	B	C	D	
803580	800	800	200	46	80x80
803590	900	900	200	46	90x90
803610	997	1000	200	48	100x100

	A	B	C	D	
802720	1000	700	250	50	100x70
802730	1000	750	250	47	100x75
802740	998	803	250	48	100x80
802750	1000	902	250	46	100x90

	A	B	C	D	
802890	1498	700	250	46	150x70
802910	1500	752	250	46	150x75
802920	1500	801	250	46	150x80
802930	1500	900	250	46	150x90

802760	1200	702	250	48	120x70
802770	1200	751	250	50	120x75
802780	1200	800	250	47	120x80
802790	1203	903	251	48	120x90

802940	1600	700	250	60	160x70
802950	1602	755	250	53	160x75
802960	1600	803	252	57	160x80
802970	1600	900	250	55	160x90

802810	1300	701	250	46	130x70
802820	1301	751	251	46	130x75
802830	1300	801	250	46	130x80
802840	1300	900	253	48	130x90

803470	1700	703	250	44	170x70
803480	1698	751	250	55	170x75

802850	1400	700	250	46	140x70
802860	1400	750	250	50	140x75
802870	1396	803	250	48	140x80
802880	1400	899	250	50	140x90

802270	1798	700	250	60	180x70
802280	1800	750	250	60	180x75
802290	1804	804	252	62	180x80
802310	1800	900	250	65	180x90

802320	2000	700	250	65	200x70
802340	2000	800	250	60	200x80
802350	2003	903	253	60	200x90



MILLENNIUM

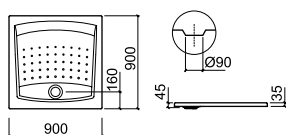

 487

800070 90x90

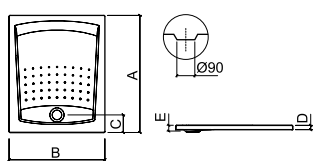

 487

	A	B	C	D	E	
800060	900	750	160	35	45	90x75
800110	1100	900	160	40	62	110x90

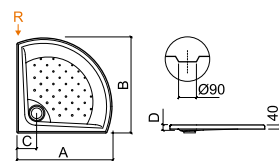

 487

	A	B	C	D	R	
800080	900	900	170	55	646	90x90
800090	1000	1000	180	50	720	100x100

FACE



 **487**

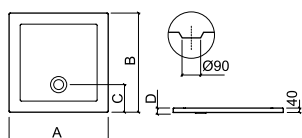

	A	B	C	D	
800280	900	900	250	25	90x90
800290	1000	1000	250	26	100x100



 **487**

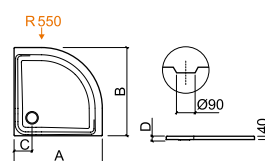

	A	B	C	D	
800170	800	800	165	20	80x80
800180	900	900	160	30	90x90
800190	1000	1000	160	35	100x100



OPEN

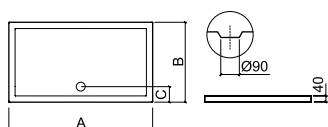

 487

	A	B	C	
801160	1000	700	178	100x70
800960	1000	750	175	100x75
800970	1000	800	175	100x80
800980	1000	900	175	100x90
801170	1200	700	180	120x70
800990	1207	755	175	120x75
801010	1206	806	175	120x80
801020	1200	900	175	120x90
801180	1400	700	175	140x70
801030	1400	750	180	140x75
801040	1400	800	180	140x80
801050	1400	900	175	140x90

	A	B	C	
801380	1500	700	177	150x70
801430	1600	700	177	160x70
801440	1600	750	177	160x75
801450	1600	800	176	160x80
801460	1600	900	176	160x90
801470	1701	701	176	170x70
801480	1700	750	176	170x75
801490	1700	800	176	170x80
801520	1800	750	176	180x75
801530	1800	800	176	180x80



METRIC

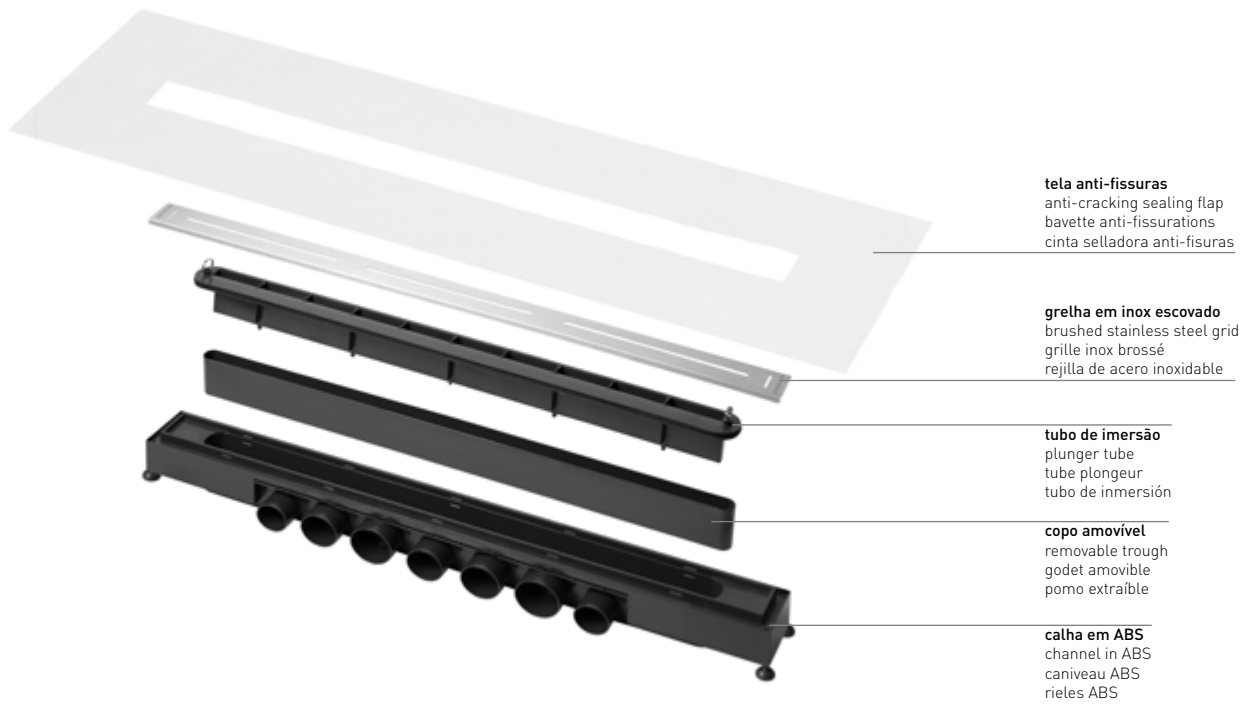

tela anti-fissuras
anti-cracking sealing flap
bavette anti-fissurations
cinta selladora anti-fisuras

grelha em inox escovado
brushed stainless steel grid
grille inox brossé
rejilla de acero inoxidable

tubo de imersão
plunger tube
tube plongeur
tubo de inmersión

copo amovível
removable trough
godet amovible
pomo extraible

calha em ABS
channel in ABS
caniveau ABS
rieles ABS

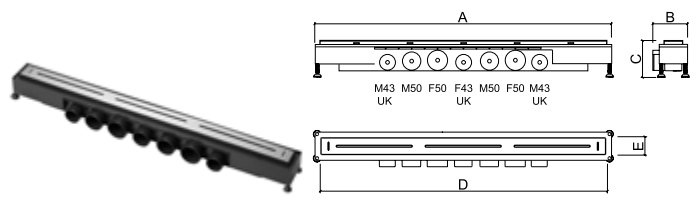

	A	B	C	D	E
49070	700	92	80-120	674	50
49080	800	92	80-120	774	50
49090	900	92	80-120	874	50





COLUNAS DE HIDROMASSAGEM
HYDROMASSAGE COLUMNS
COLONNES D'HYDROMASSAGE
COLUMNAS DE HIDROMASAJE

Coleção
Collection
Collection
Colección

326 Shadow



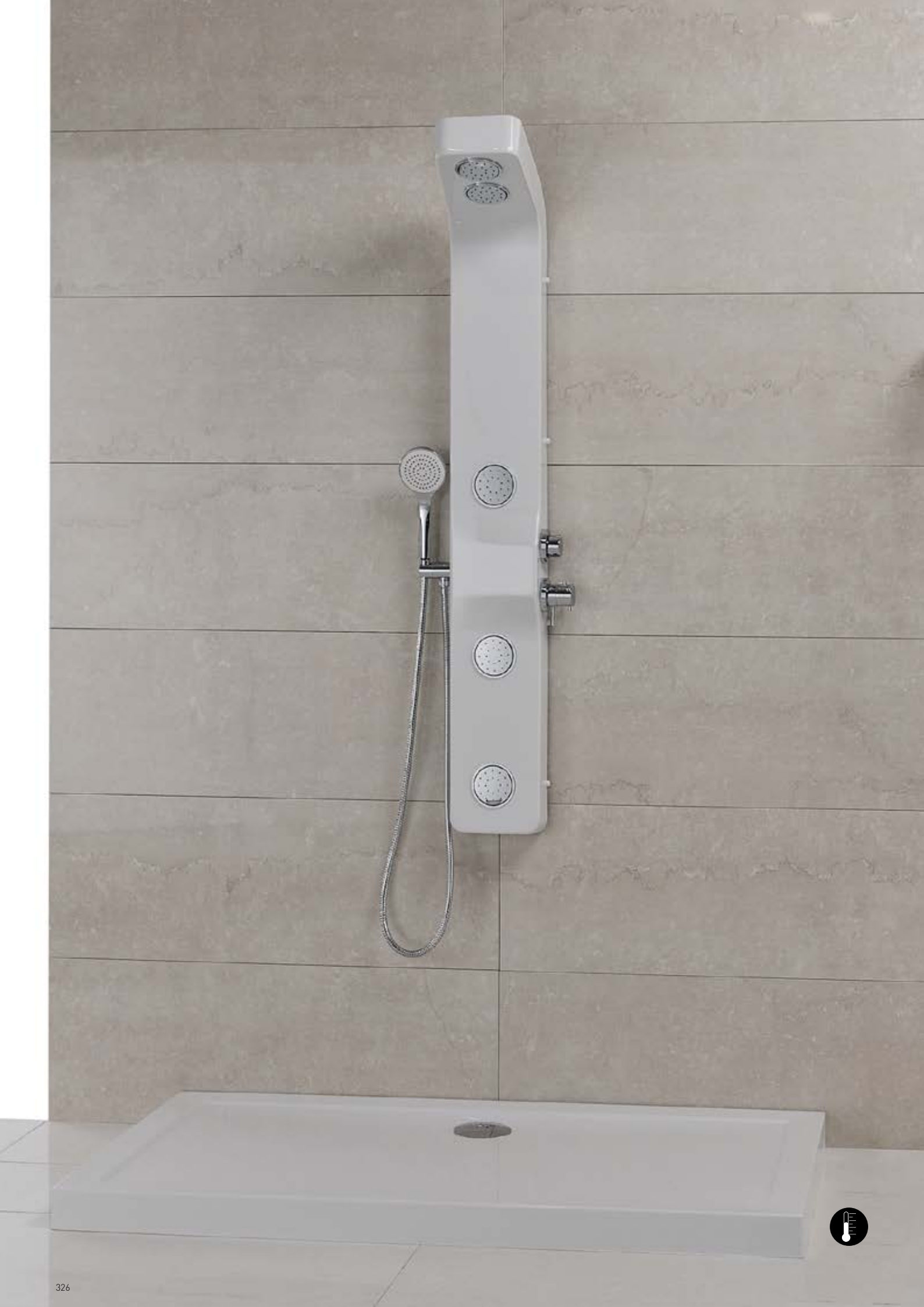

SHADOW

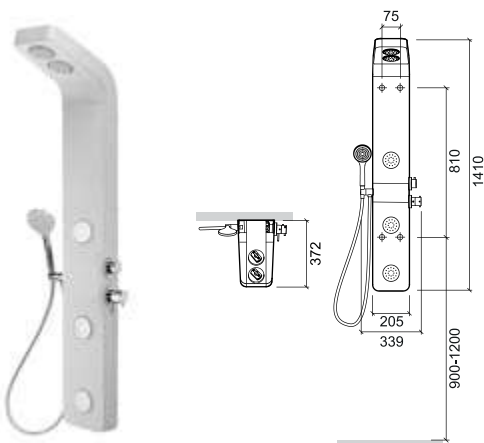

88878411

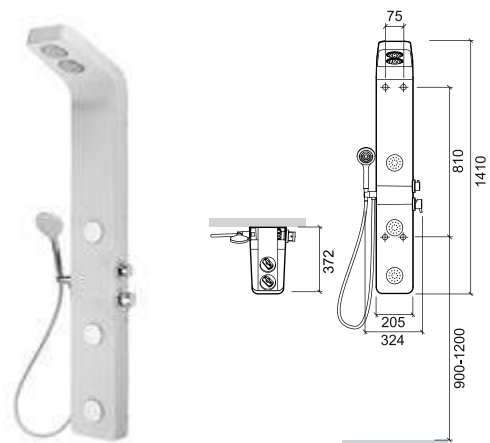

88878011







DIVISÓRIAS
SHOWER SCREENS
PAROIS
MAMPARAS

Banheiras

Bathtubs

Baignoires

Bañeras

330 Versus

332 Aquarela duo

333 Aquarela

Bases de duche

Shower trays

Receveurs de douche

Platos de ducha

334 Strado

338 Screen

340 Versus





VERSUS



Cores | Colours | Couleurs | Colores



branco
white
blanc
blanco



cromado
chrome
chrome
cromo

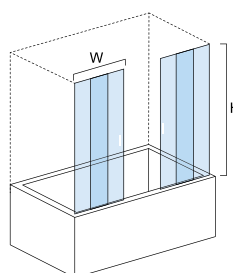

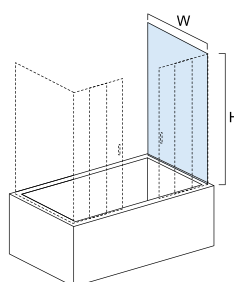

	W	H	MIN	MAX
89350500	1500	1400	1480	1520
89352500	1600	1400	1590	1610
89353500	1700	1400	1690	1710
89354500	1750	1400	1740	1760
89355500	1800	1400	1790	1810
89356500	1900	1400	1890	1910

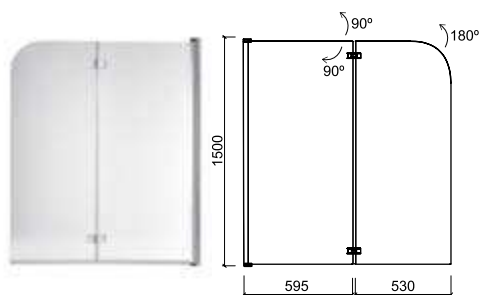

	W	H	MIN	MAX
89360100	700	1400	690	710
89361100	750	1400	740	760
89362100	800	1400	790	810
89363100	900	1400	890	910

AQUARELA DUO



89509000  89509010 

Cores | Colours | Couleurs | Colores



branco
white
blanc
blanco



cromado
chrome
chrome
cromo

AQUARELA



Cores | Colours | Couleurs | Colores



branco
white
blanc
blanco



cromado
chrome
chrome
cromo

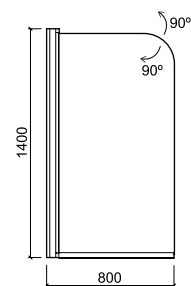

89509100 



STRADO

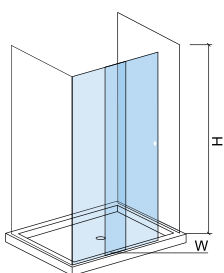

		W	H	MIN	MAX
		89089200	89089210	952	1971 942 962
		89037200	89037210	1182	1970 1172 1192
		89038200	89038210	1401	1970 1391 1411
		89039200	89039210	1582	1970 1572 1592
		89041200	89041210	1682	1970 1672 1692
		89042200	89042210	1801	1969 1791 1811

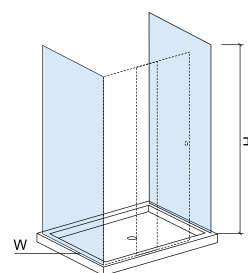

	W	H	MIN	MAX
	89066200	700	1970	677 692
	89067200	751	1970	731 751
	89068200	801	1970	749 769
	89069200	901	1970	849 869

STRADO

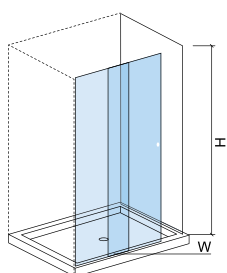



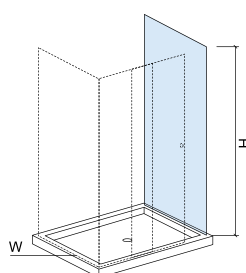





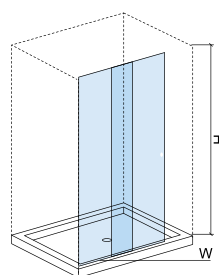



		W	H	MIN	MAX		
		89089100	89089110	971	1971	966	986
		89037100	89037110	1201	1970	1191	1211
		89038100	89038110	1408	1970	1398	1418
		89039100	89039110	1608	1971	1598	1618
		89041100	89041110	1708	1970	1698	1718
		89042100	89042110	1801	1969	1791	1818



	W	H	MIN	MAX
89066100	700	1970	677	692
89067100	751	1970	731	751
89068100	801	1970	749	769
89069100	901	1970	849	869

STRADO



		W	H	MIN	MAX
 89089000	 89089010	1002	1971	992	1011
 89037000	 89037010	1201	1970	1191	1011
 89038000	 89038010	1401	1970	1391	1411
 89039000	 89039010	1602	1970	1592	1611
 89041000	 89041010	1702	1970	1691	1711
 89042000	 89042010	1801	1969	1791	1811





SCREEN

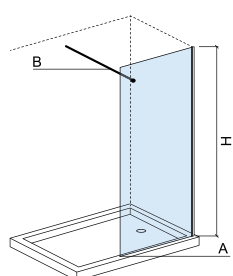

	A	B	H
89410100	940	664-864	2050
89412100	1140	664-864	2050
89414100	1340	664-864	2050
89416100	1540	664-864	2050

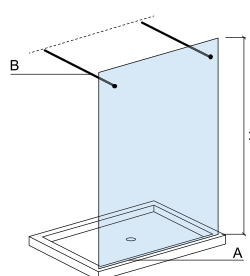

	A	B	H
89410000	940	664-864	2043
89412000	1140	664-864	2043
89414000	1340	664-864	2043
89416000	1540	664-864	2043



VERSUS

Cores | Colours | Couleurs | Colores



branco
white
blanc
blanco



cromado
chrome
chrome
cromo

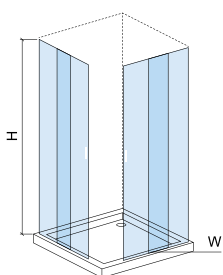

	W	H	MIN	MAX
89301000	750	1900	740	760
89303000	800	1900	790	810
89304000	900	1900	890	910

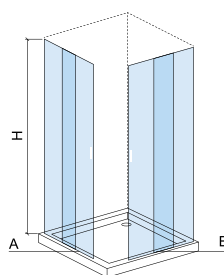

	A	B	H	900		700	
				MIN	MAX	MIN	MAX
89400000	900	700	1900	890	910	690	710



VERSUS



Cores | Colours | Couleurs | Colores

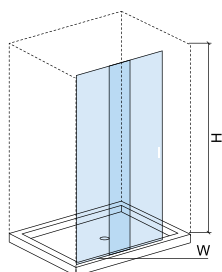

	W	H	MIN	MAX
89310000	1000	1900	980	1020
89312000	1200	1900	1180	1220
89314000	1400	1900	1380	1420



branco
white
blanc
blanco



cromado
chrome
chrome
cromo

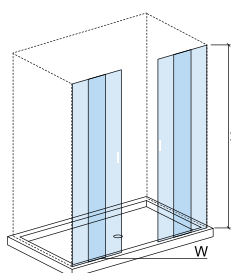

	W	H	MIN	MAX
89315500	1500	1900	1480	1520
89316500	1600	1900	1580	1620
89317500	1700	1900	1680	1720
89318500	1800	1900	1780	1820

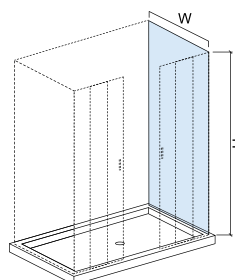

	W	H	MIN	MAX
89310100	700	1900	690	710
89311100	750	1900	740	760
89312100	800	1900	790	810
89313100	900	1900	890	910



MISTURADORAS DE WC BATHROOM MIXERS ROBINETS DE SALLE DE BAINS GRIFOS DE BAÑO

Coleções Collections Collections Colecciones

- 352 WCA
- 356 Line 42
- 362 Status
- 364 Tube NEW
- 364 Tube Eco NEW
- 374 Advance NEW
- 378 Ícone
- 378 Ícone Eco
- 380 Master 40 NEW
- 384 Torus
- 388 Single Plus
- 390 Alfa
- 392 New Ícone NEW
- 402 Single
- 404 Start
- 405 B-Touch
- 406 Easy
- 408 Cetus Basic
- 411 Rimini

Torneiras temporizadas Timed taps Robinets temporisée Grifos temporizados

- 416 Tube
- 417 Ícone
- 418 New Ícone
- 419 Lock
- 420 Eco

Torneiras eletrônicas Electronic taps Robinets électroniques Grifos electrónicos

- 424 Novel NEW
- 426 Square
- 427 Tube
- 428 Advance NEW
- 429 Wave NEW
- 430 Twocare NEW
- 431 Hera
- 432 Bio
- 433 Basic
- 434 Unit
- 434 Plan

Torneira de coluna Pillar tap Robinet simple Grifo

- 435 Simple 30
- 436 **Acessórios para lavatórios** NEW
Basins accessories
Accessoires pour lavabos
Accesorios para lavabos

Soluções para duche Shower solutions Solutions de douche Soluciones de ducha

- 440 Kits de duche NEW
Shower kits
Kits douche
Kits de ducha
- 444 Pinhas/hastes NEW
Shower heads/arms
Douches de tête/bras
Cabezal ducha/barras
- 450 Chuveiros de mão
Hand showers
Douchettes à main
Duchas de mano
- 453 Flexíveis de duche
Shower hoses
Flexibles de douche
Flexibles de ducha
- 454 **Suportes e saídas de água** NEW
Brackets and water outlets
Supports et sorties d'eau
Soportes y salidas de agua
- 457 Injetores de hidromassagem
Hydromassage jets
Jets d'hydromassage
Inyectores de hidromasaje
- 458 **Rampas** NEW
Sliding rails
Barres de douche
Barras de ducha
- 461 Mini-misturadoras de duche
Mini shower mixers
Mini mitigeurs de douche
Mini mezcladores de ducha





Misturadoras encastráveis
Wall mounted mixers
Mitigeurs encastrés
Monomandos empotrables

A funcionalidade das misturadoras de encastrar, de cozinha ou casa de banho, assenta essencialmente na tipologia de instalação mural que oferece vantagens ao nível da economia de espaço e da facilidade de limpeza.

A conjugação com outros produtos permite criar soluções ajustadas às preferências e necessidades de cada utilizador criando ambientes tanto minimalistas quanto elegantes e marcantes.

Wall mounted kitchen and bathroom mixers are very functional because of their concealed installation which creates design advantages in terms of space savings and hygiene.

By combining these mixers with other products you can produce tailored solutions adjusted to the preferences and needs of each user. They're perfect for all design concepts.

La fonctionnalité des mitigeurs encastrés, de cuisine ou de salle de bains repose essentiellement sur le type d'installation murale qui offre des avantages en termes d'économie d'espace et de facilité de nettoyage.

La combinaison avec d'autres produits permet de créer des solutions adaptées aux préférences et aux besoins de chaque utilisateur en créant des environnements à la fois minimalistes et élégants et saisissants.

La funcionalidad de los monomandos de pared, de cocina o baño se basa esencialmente en el tipo de instalación de pared que ofrece ventajas en términos de ahorro de espacio y facilidad de limpieza.

La combinación con otros productos permite crear soluciones ajustadas a las preferencias y necesidades de cada usuario creando ambientes tanto minimalistas como elegantes y llamativos.



LINE 42

Misturadoras termostáticas
Thermostatic mixers
Mitigeurs thermostatiques
Monomandos termostáticos



As misturadoras termostáticas têm a capacidade de manter a água à temperatura desejada. Foram pensadas para possibilitar um banho relaxante sem preocupação com oscilações térmicas, mesmo quando outra torneira é aberta. Equipadas com o sistema antiescaldão impedem queimaduras cutâneas em caso de contacto com as superfícies metálicas. Estas são as torneiras mais seguras para crianças.

Thermostatic mixers hold water at a preset temperature. They are designed to function without temperature fluctuations, even when another tap is running. They're equipped with an anti-scalding system which prevents skin burns in case of contact with the taps metal surfaces. These are the safest taps for children.

Les mitigeurs thermostatiques ont la capacité de maintenir l'eau à la température souhaitée. Ils sont conçus pour permettre un bain relaxant sans se soucier des fluctuations de température, même lorsqu'un autre robinet est ouvert. Équipés du système anti-brûlure, ils préviennent les brûlures de la peau en cas de contact avec des surfaces métalliques. Ce sont les robinets les plus sûrs pour les enfants.

Los monomandos termostáticos tienen la capacidad de mantener el agua a la temperatura deseada. Están diseñados para permitir un baño relajante sin preocuparse por las fluctuaciones de temperatura, incluso cuando se abre otro grifo. Equipados con el sistema antiquemaduras, previenen las quemaduras de la piel en caso de contacto con sus superficies metálicas. Estos son los grifos más seguros para los niños.



B-TOUCH

ECOSPOT



As misturadoras com o sistema **Ecospot** são equipadas com um cartucho que regula o caudal através de uma abertura faseada do manípulo. Esta tecnologia permite abrir em duas posições: meia abertura e abertura total, garantido deste modo, uma redução significativa no consumo de água e de energia.

Mixers with **Ecospot** system are equipped with a cartridge that regulates the flow through a phased opening of the lever handle. This technology allows a two position opening: half open and fully open. This system guarantees a significant reduction in water and energy consumption.

Les mitigeurs dotés du système **Ecospot** sont équipés d'une cartouche qui régule le débit par une ouverture progressive du levier. Cette technologie permet une ouverture dans deux positions : une ouverture à moitié et une ouverture totale, assurant ainsi une réduction significative de la consommation d'eau et d'énergie.

Los monomandos con el sistema **Ecospot** están equipados con un cartucho que regula el flujo de agua a través de una apertura situada en la maneta. Esta tecnología permite la apertura en dos posiciones: media apertura y apertura completa, garantizando así una reducción significativa del consumo de agua y energía.



TORUS

Caudal
Flow rate
Débit
Caudal



No seguimento da sua política de proteção e defesa do meio ambiente a Sanindusa tem vindo a desenvolver campanhas de incentivo a comportamentos ecológicos e, ao mesmo tempo, apostado no desenvolvimento de produtos que reduzam os consumos de água e energia ao máximo. Como resultado deste investimento a empresa apresentou as séries Master 40, Tube Eco, Ícone Eco, Sigma, Alfa, Square e Área, equipadas com um regulador de caudal que possibilita uma economia até 50% no consumo de água e gera uma redução de energia necessária ao aquecimento da água. Este dispositivo reduz também as variações de pressão na rede quando várias torneiras estão abertas em simultâneo.

Following their environment protection policy Sanindusa has been developing campaigns to encourage environmentally friendly behaviors like developing products that reduce water and energy consumption to the maximum. As a result of this investment the company presented the Master 40, Tube Eco, Ícone Eco, Sigma, Alfa, Square and Área collections which are equipped with a flow regulator that allows up to 50% water savings and reduces the energy needed for water heating. This device also reduces the pressure variations in the network when multiple taps are open at the same time.

Suite à sa politique de protection et de défense de l'environnement, Sanindusa a développé des campagnes pour encourager les comportements écologiques et, en même temps, a investi dans le développement de produits qui réduisent les consommations en eau et en énergie au maximum. En conséquence de cet investissement, nous présentons les séries Master 40, Tube Eco, Ícone Eco, Sigma, Alfa, Square et Área, équipées d'un régulateur de débit qui permet d'économiser jusqu'à 50% de la consommation en eau et de réduire l'énergie nécessaire pour chauffer l'eau. Ce dispositif réduit également les variations de pression sur le réseau lorsque plusieurs robinets sont ouverts en même temps.

Siguiendo su política de protección y defensa del medio ambiente Sanindusa ha venido desarrollando campañas para fomentar comportamientos ecológicos y, al mismo tiempo, se ha centrado en el desarrollo de productos que reduzcan al máximo el consumo de agua y energía. Como resultado de esta inversión presentamos las series Master 40, Tube Eco, Ícone Eco, Sigma, Alfa, Square y Área, equipadas con un regulador de flujo que permite un ahorro de hasta el 50% en el consumo de agua y genera una reducción de la energía necesaria para calentar el agua. Este dispositivo también reduce las variaciones de presión en la red cuando se abren varios grifos simultáneamente.



MASTER 40

COLDOPEN



O sistema de abertura **Cold Open** é um dispositivo que permite a poupança de recursos hídricos e energéticos. A abertura do manípulo para a direita está bloqueada, pelo que quando se procede à abertura da misturadora sairá água fria (quando alinhado pela bica), não colocando em funcionamento o esquentador ou acumulador, havendo por isso, economia energética. Ao girar o manípulo para a esquerda para obter mistura, obtém-se gradualmente água quente. Em misturadoras equipadas com cartuchos **Cold Open** a abertura da água pode fazer-se em qualquer ponto de rotação do manípulo, contrariamente aos sistemas progressivos em que a abertura se inicia obrigatoriamente na água fria passando progressivamente, com a rotação do manípulo, para água temperada e depois quente.

Cold Open is a water and energy saving system for taps. The opening of the knob to the right is blocked which means that when the mixer tap is open it will only release cold water. When aligned at the spout the water heater or accumulator will not be activated saving energy resources. When the knob is turned to the left hot water will gradually be produced. Mixer taps equipped with Cold Open cartridges can be opened at any point of the rotation of the knob contrary to the systems in which the opening starts necessarily in cold water, progressively changing to warm and then hot water.

Le système d'ouverture **Cold Open** est un dispositif qui permet d'économiser les ressources hydriques et énergétiques. L'ouverture du levier vers la droite est bloquée, aussi, quand le mitigeur est ouvert, il en sort de l'eau froide (quand alignée avec le bec), ce qui ne met pas en marche le chauffe-eau ou l'accumulateur, et génère donc une économie d'énergie. En tournant le levier vers la gauche pour actionner le mitigeur, il en sort progressivement de l'eau chaude. Sur les mitigeurs équipés de cartouches **Cold Open** l'ouverture de l'eau peut se faire en tout point de rotation du levier, contrairement aux systèmes progressifs où l'ouverture commence obligatoirement avec l'eau froide en passant progressivement à l'eau tiède puis chaude, en tournant le levier.

El sistema **Cold Open** es un dispositivo que permite ahorrar recursos de agua y energía. La apertura del pomo de la derecha está bloqueada, de modo que cuando el grifo mezclador esté abierto, sólo liberará agua fría (cuando esté alineado en el caño), por lo que el calentador de agua o el acumulador no se activará, lo que permitirá ahorrar energía. Cuando se gira el pomo hacia la izquierda para obtener agua mezclada, se producirá gradualmente agua caliente. Los grifos mezcladores equipados con cartuchos **Cold Open** pueden abrirse en cualquier punto de rotación del mando, al contrario de los sistemas progresivos en los que la apertura comienza necesariamente en agua fría, cambiando progresivamente a agua templada y luego a agua caliente cuando el mando se convierte.



VIDEO



ÍCONE



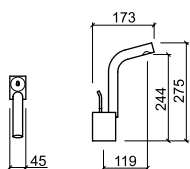

5114301 5114300 TIC TAC

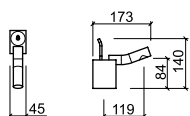

5110301 5110300 TIC TAC

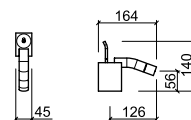

5110401 5110400 TIC TAC

WCA

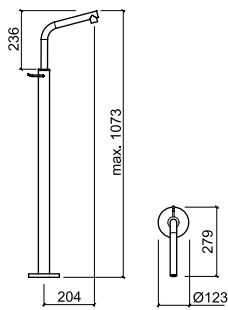

5110101

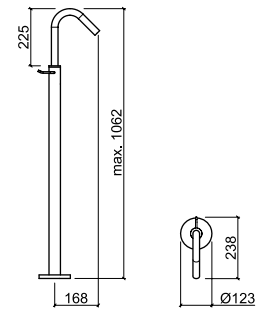

5110001

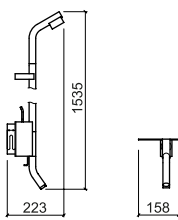

5112801

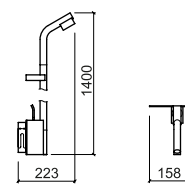

5112701





LINE 42



Cores | Colours | Couleurs | Colores



cromado
chrome
chrome
cromo



preto/cromado
black/chrome
noir/chrome
negro/cromo



branco/cromado
white/chrome
blanc/chrome
blanco/cromo



níquel
nickel
níquel



grafite
graphite
graphite
grafito



dourado
gold
doré
dorado



cobre
copper
couvre
cubre



*** rainbow**

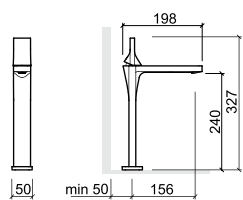

5554301 *

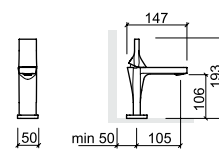

5550301

LINE 42



Cores | Colours | Couleurs | Colores



cromado
chrome
chrome
cromo



preto/cromado
black/chrome
noir/chrome
negro/cromo



branco/cromado
white/chrome
blanc/chrome
blanco/cromo

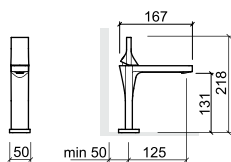

5557301

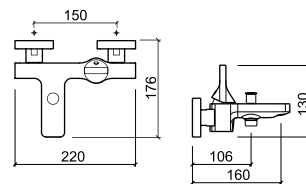

5550801

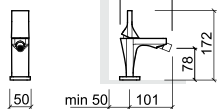

5550401

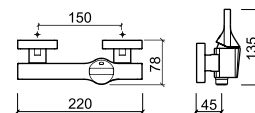

5550701





LINE 42

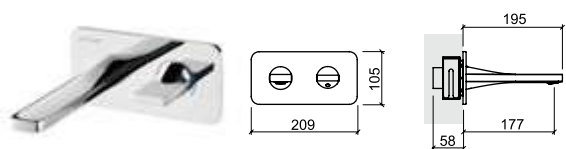

5552301

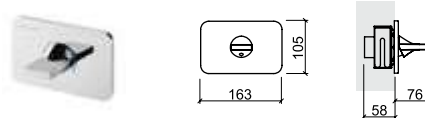

5557101 3V

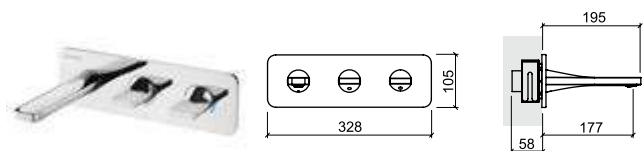

5557801 4V

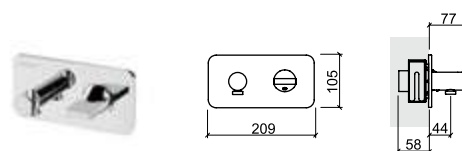

5552701

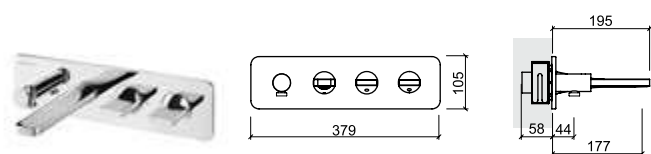

5552801 4V

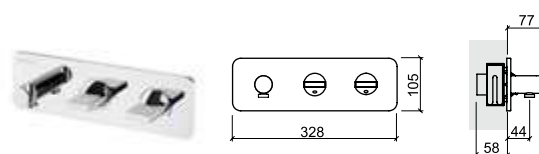

5556701 4V



STATUS

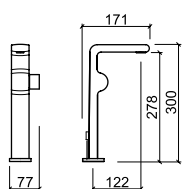

5394301 5394300 

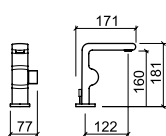

5390301 5390300 

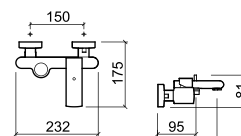

5390801

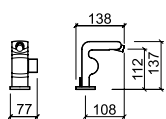

5390401 5390400 

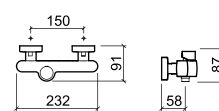

5390701



TUBE | TUBE ECO

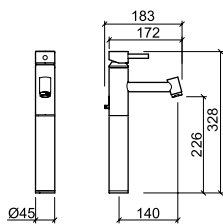

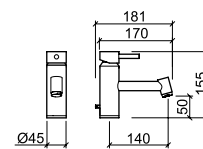

5314301 5314300 

 5514301 5514300 



5317301

 5517301 5517300 

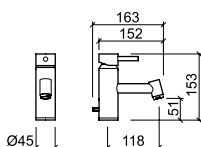

5310301 5310300 

 5510301 5510300 

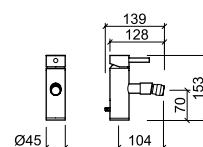

5310401 5310400 

 5510401 5510400 

TUBE | TUBE ECO

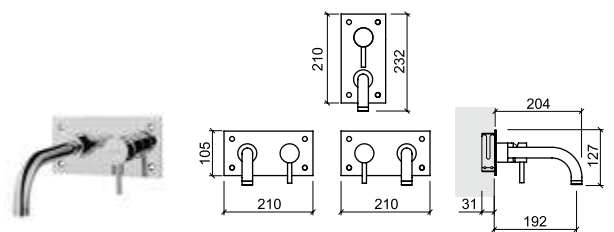

5312301



5512301

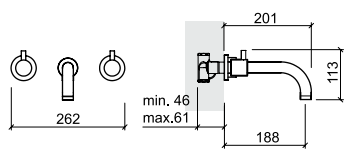

5312311

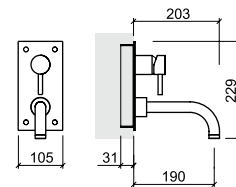

5315301

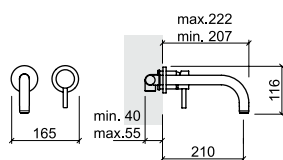

5311301 *

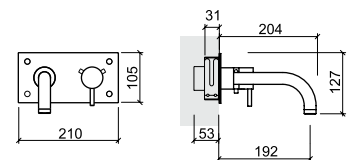

5319301





0
sinnova

sinnova

L'ORÉAL MD
Clean Facial Wash
HYPOALLERGENIC



TUBE | TUBE ECO

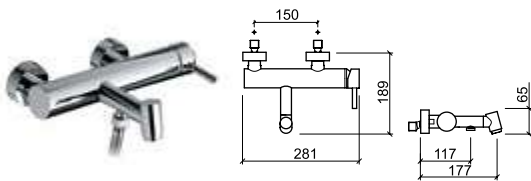

5310801

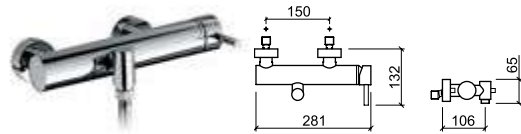

5310701

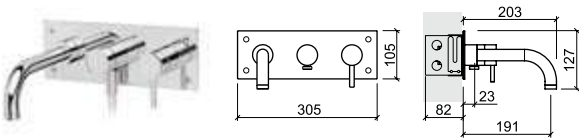

5312801C

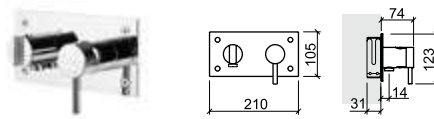

5312701

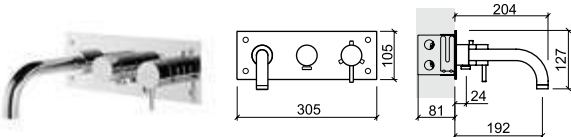

5316801

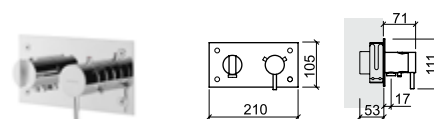

5314701

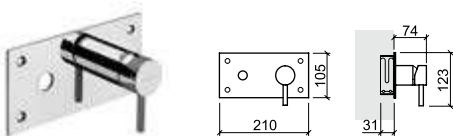

5317701 + kit face

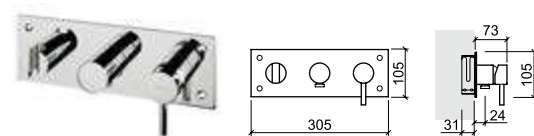

5316701

Face p.442
5R890701

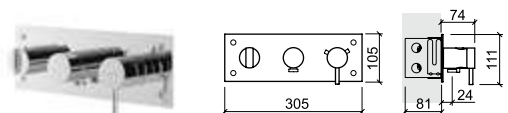

5314801

TUBE

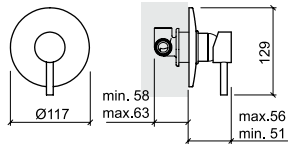

5311701C 3V

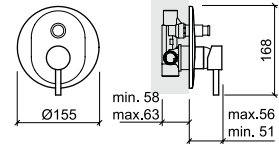

5311801C 4V

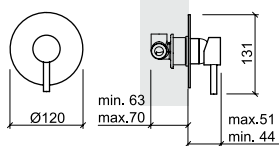

5318701 3V

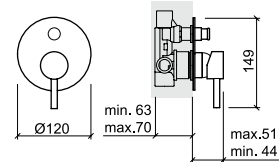

5317801 4V

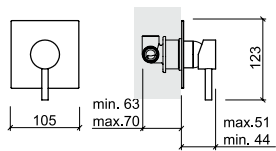

5317101 3V

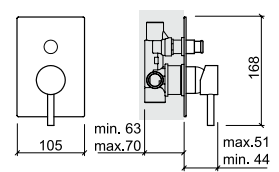

5318801 4V





TUBE

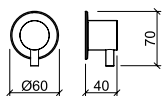

56800

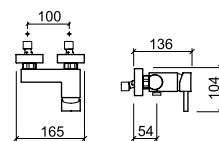

5317001 + kit aqua 

Aqua p.452
56691

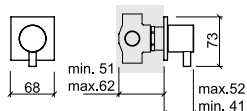

5310601



5310561 **5310561F** 



5311561 **5311561F** 

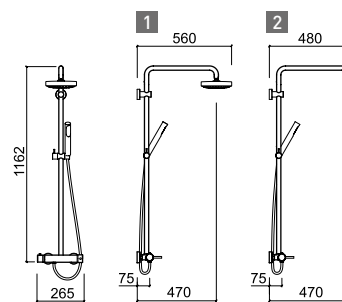
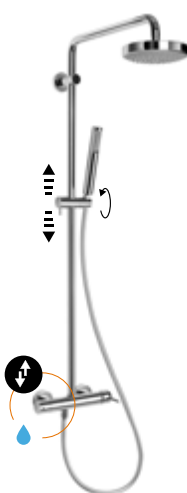

1 **5315701** **2** **5315701S**



REVOLUS

ADVANCE

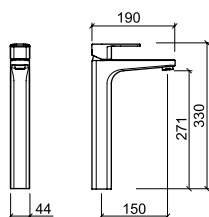

5274301

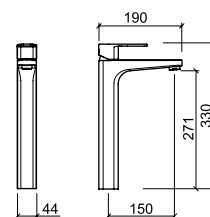

5274331

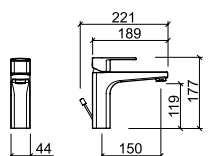

5277301 5277300

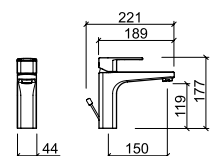

5277331 5277330

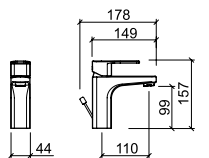

5270301 5270300

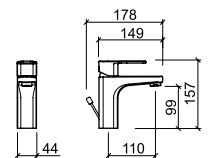

5270331 5270330

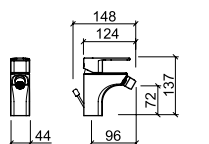

5270401 5270400

ADVANCE

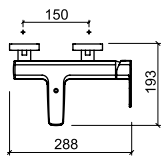

5270801

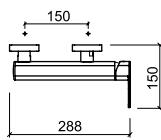
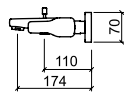

5270701

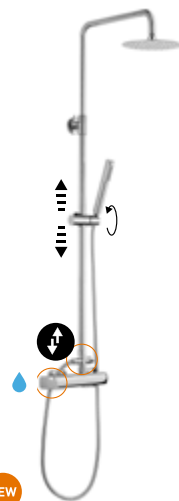
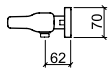

NEW

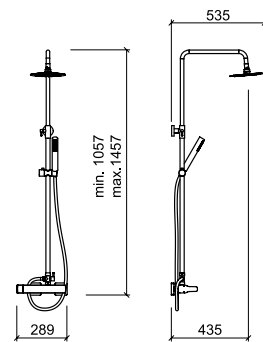

5276701







ÍCONE | ÍCONE ECO

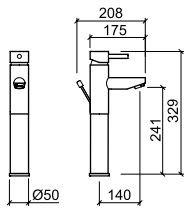

5504301 5504300

5524301 5524300

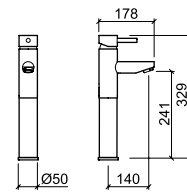

5504331

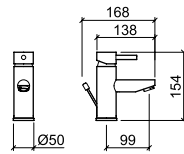

5500301 5500300

5520301 5520300

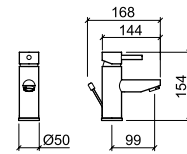

5501001 5501000

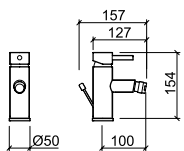

5500401 5500400

5520401 5520400

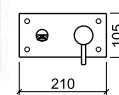

5502301

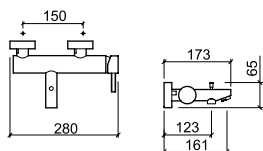
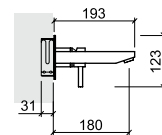

5500801

5520801

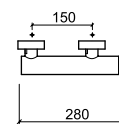

5500701

5520701



sanrio sa

MASTER 40



5254301 5254300

5257301 5257300

5252301

5250301 5250300

5250801 5250801C

5250401 5250400

5250701 5250701C

MASTER 40

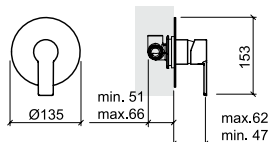

5251701C 3V

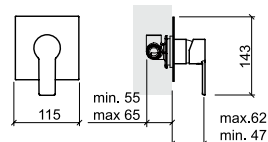

5257101C 3V

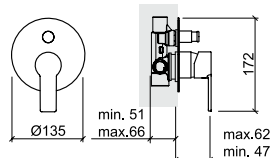

5251801C 4V

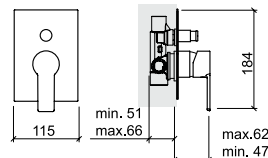

5257801C 4V

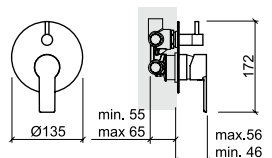

5251601C 5V

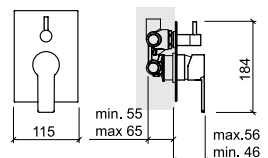

5257601C 5V





TORUS

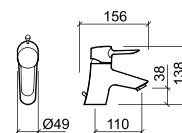
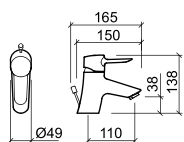

5370301 5370300 

5371001

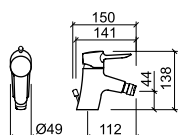

5370401 5370400 

TORUS

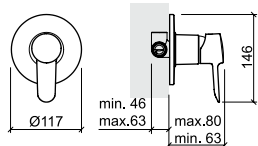

5371701C 3V

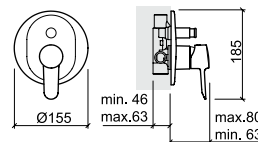

5371801C 4V

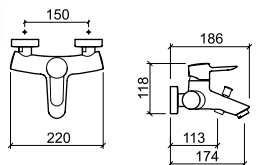

5370801

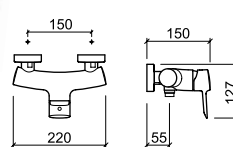

5370701

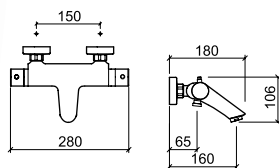

5374801 f

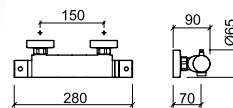

5374701 f

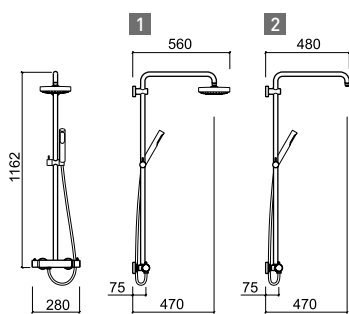
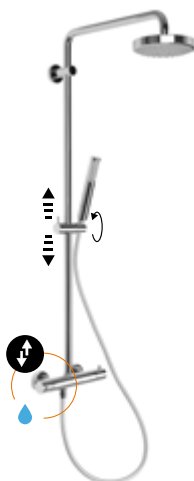

1 5377721 2 5377721S

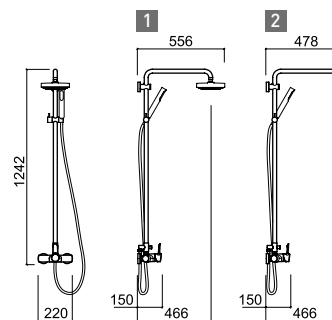
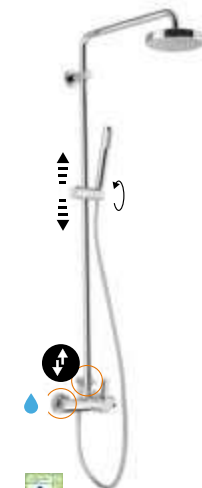

1 5376701 2 5376701S







SINGLE PLUS

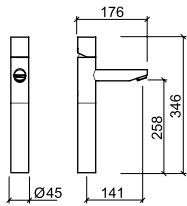

5064301

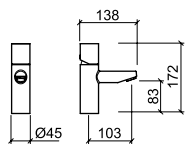

5060301

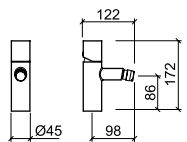

5060401

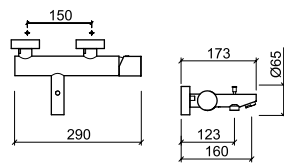

5060801

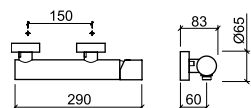

5060701

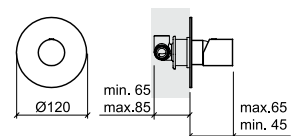

5061701C 3V

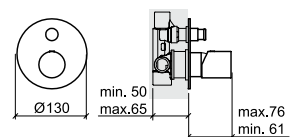

5061801C 4V

ALFA

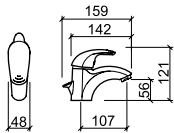

5000301 5000300 

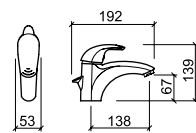

5004300

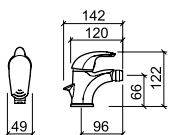

5000401 5000400 

ALFA

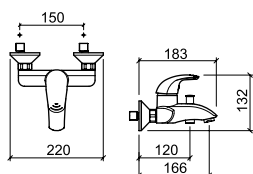

5000801 omega
5000801B beta

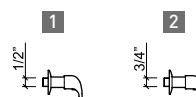

1 5000661 2 5000961

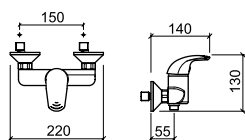

5000701 omega
5000701B beta

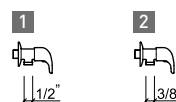

1 5000561 2 5001561
1 5000561F 2 5001561F

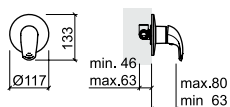

5001701C

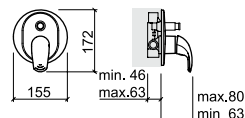

5001801C

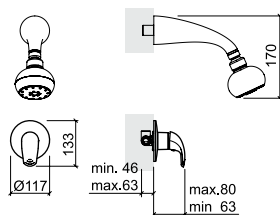

5001701

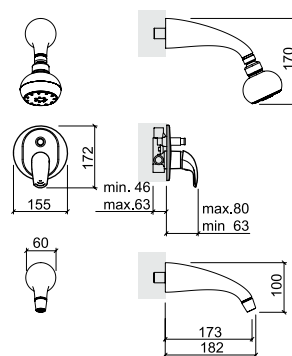

5001801



NEW ÍCONE

Cores | Colours | Couleurs | Colores



cromado
chrome
chrome
cromo



*** preto**
black
noir
negro

NEW

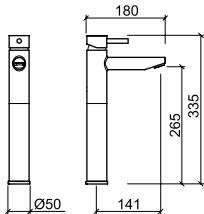

5264301 *

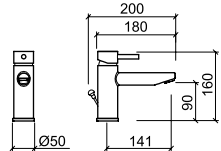

5267301 **5267300**

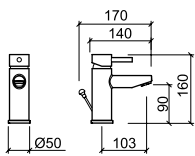

5260301 * **5260300**

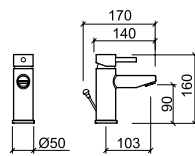

5261001 **5261000**

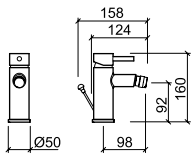

5260401 **5260400**

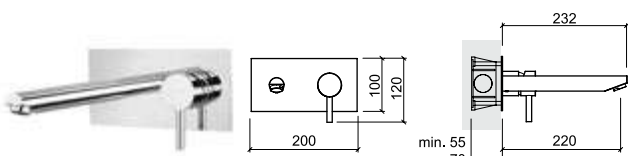

5262301

NEW ÍCONE

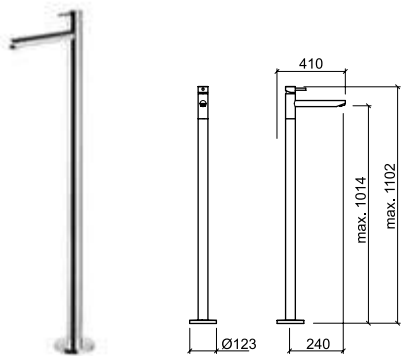

5260101

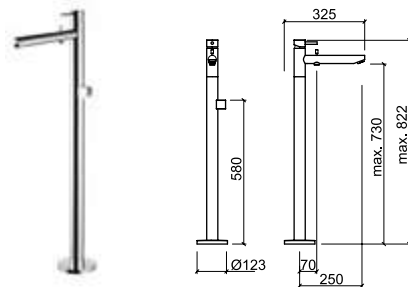

5268801

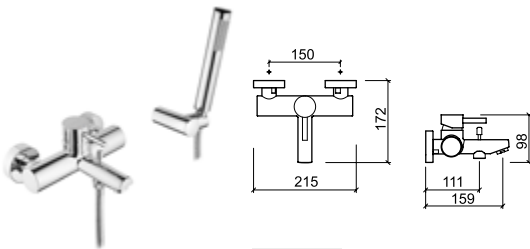

5260801

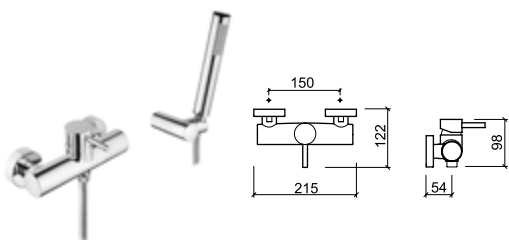

5260701

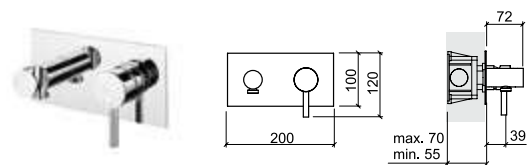

5262701





NEW ÍCONE

Cores | Colours | Couleurs | Colores



cromado
chrome
chrome
cromo

*** preto**
black
noir
negro

NEW

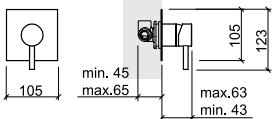

5267101C * 3V

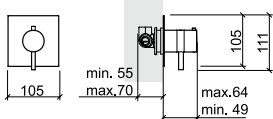

5268701C 3V

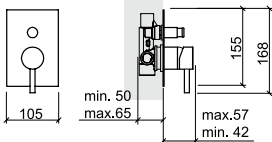

5267801C * 4V

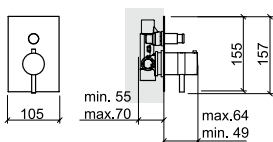

5266801C 4V

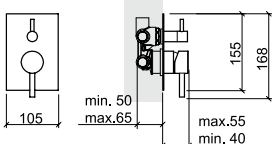

5267601C * 5V

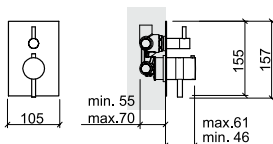

5266601C 5V

NEW ÍCONE

Cores | Colours | Couleurs | Colores



cromado
chrome
chrome
cromo



*** preto**
black
noir
negro

NEW

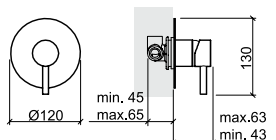

5261701C * 3V

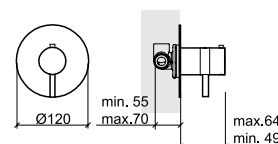

5264701C 3V

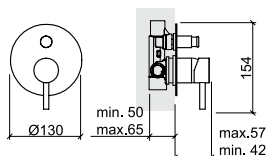

5261801C * 4V

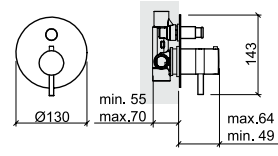

5264801C 4V

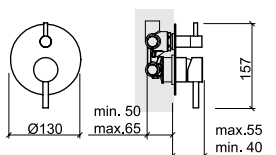

5261601C * 5V

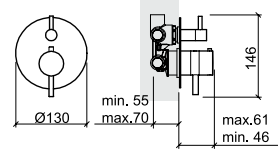

5264601C 5V





NEW ÍCONE

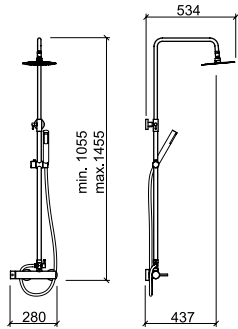
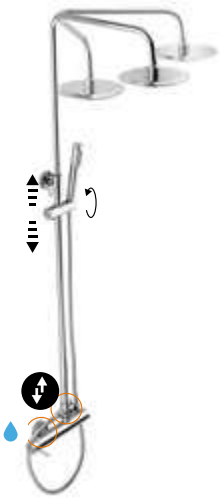

5266701

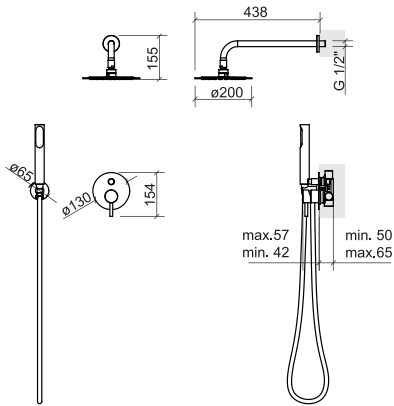

5269802 4V

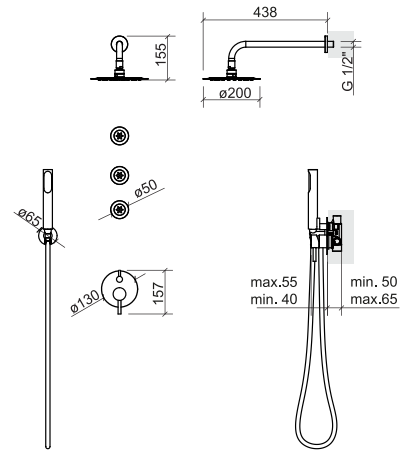

5269603 5V

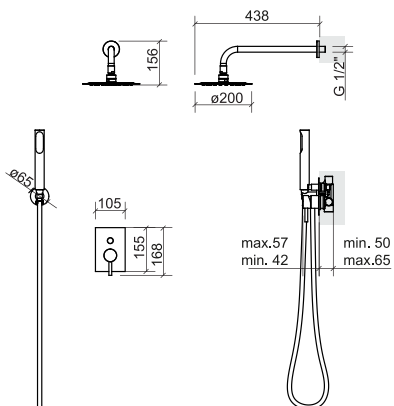

5269804 4V

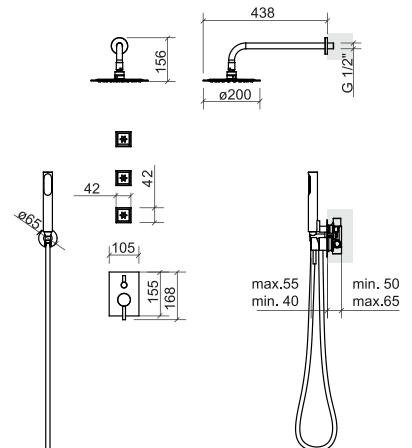

5269605 5V



SINGLE

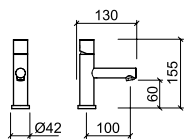

5540301

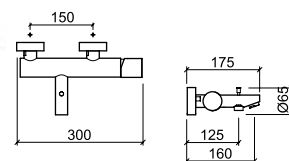

5540801

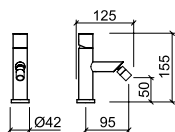

5540401

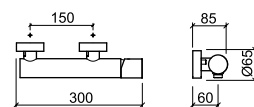

5540701

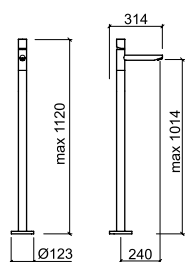

5540101

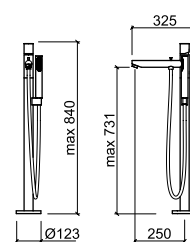

5548801



START

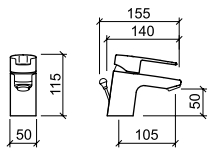

5580301 5580300 

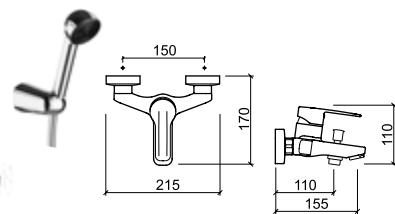

5580801

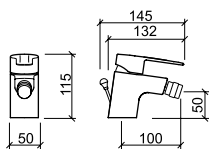

5580401 5580400 

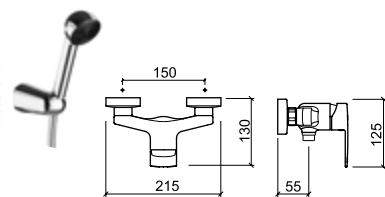

5580701

B-TOUCH

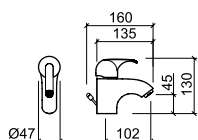

5340301 5340300 

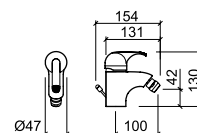

5340401 5340400 

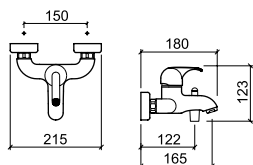

5340801

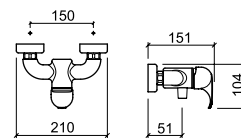

5340701

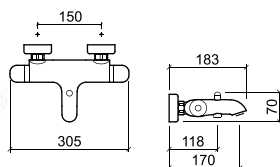

5344801 

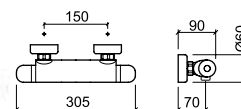

5344701 



EASY

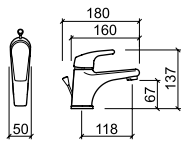

5364300

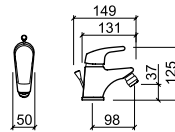

5360401 5360400

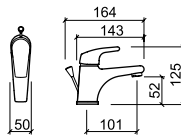

5360301 5360300

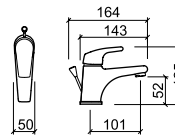

5360301NF 5360300NF 5360302NF

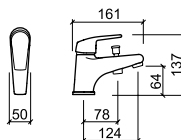

5360381

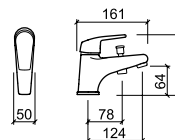

5360381NF

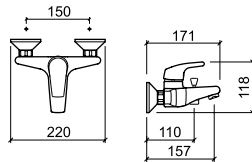

5360801

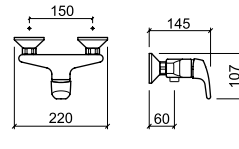

5360701

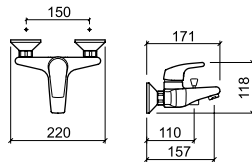

5360801SNF

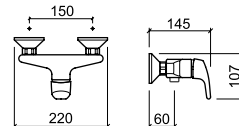

5360701SNF



CETUS BASIC

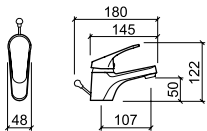

5570301 5570300 

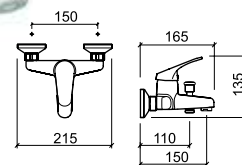

5570801

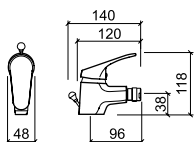

5570401 5570400 

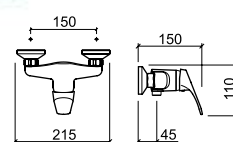

5570701



RIMINI

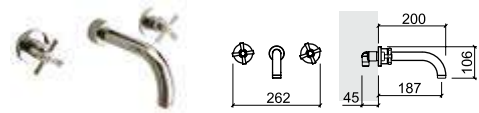

5185361

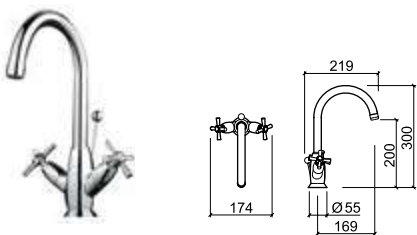

5180361 5180360

5180311 5180310

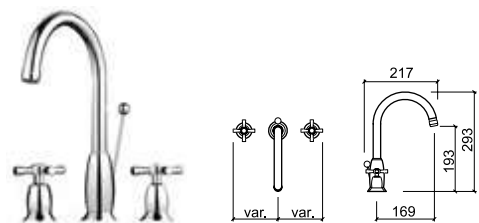

5181361 5181360

5181311 5181310

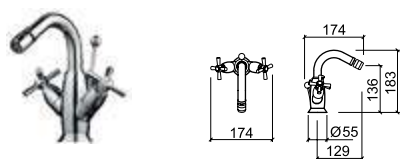

5180461 5180460

5180411 5180410

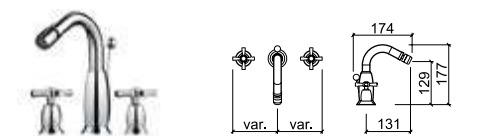

5181461 5181460

5181411 5181410

RIMINI

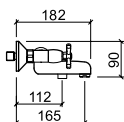
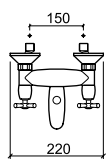

5180861

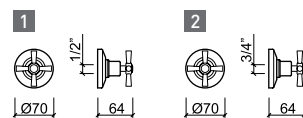
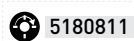

1 5180661Q 2 5180961Q

1 5180661F 2 5180961F

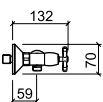
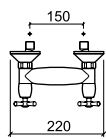

5180761

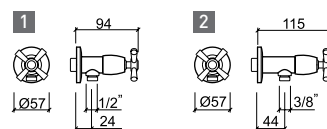
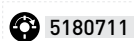

1 5180561 2 5181561

1 5180561F 2 5181561F

Torneiras temporizadas
Timed taps
Robinets temporisée
Grifos temporizados





LOCK

Torneiras temporizadas
Timed taps
Robinets temporisée
Grifos temporizados



As torneiras temporizadas são acionadas através da pressão manual no pulsador que se desligará automaticamente após breves segundos. Apresentam inúmeras vantagens sendo a mais relevante a poupança significativa de água. O caudal pré-regulado de fábrica é ajustável em função da necessidade e onde quer que sejam aplicadas são extremamente práticas e fáceis de usar.

Timed taps can be operated by pressing down on their pushbutton, this will start the water flow and after a few seconds the tap will switch off automatically.

These taps have several advantages. They are extremely practical, easy to use, reduce water consumption and the pre-set flow rate can be adjusted.

Les robinets temporisés sont actionnés par une pression manuelle sur le bouton-poussoir qui s'éteint automatiquement après quelques secondes. Ils présentent de nombreux avantages, le plus important étant les économies d'eau significatives. Le débit pré-réglé en usine est réglable en fonction des besoins et, quel que soit l'endroit où ils sont appliqués, ils sont extrêmement pratiques et faciles à utiliser.

Los grifos temporizados se accionan mediante la presión manual del pulsador que se apagará automáticamente después de unos segundos.

Tienen numerosas ventajas, siendo la más relevante el importante ahorro de agua. El caudal de agua preestablecido en fábrica es ajustable según las necesidades y dondequiera que se apliquen son extremadamente prácticos y fáciles de usar.



TUBE

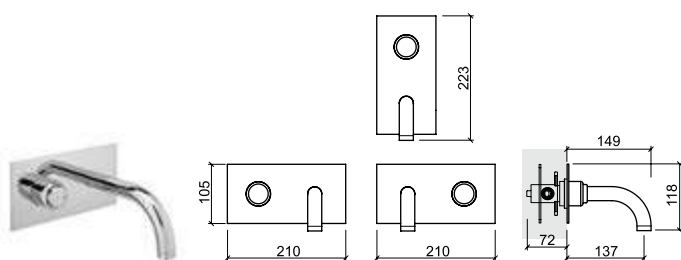

5312341

ÍCONE

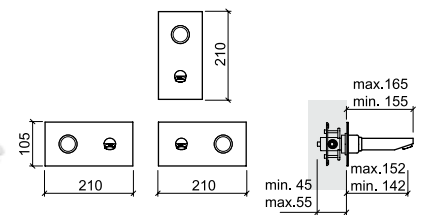

5502341

NEW ÍCONE

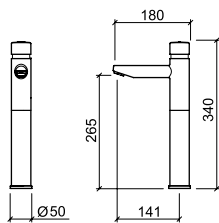

5265341

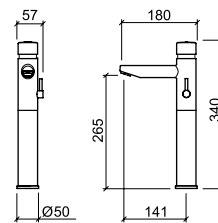

5264341

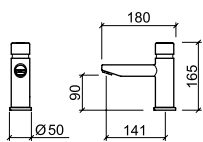

5266341

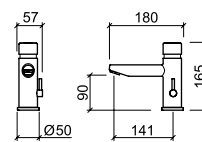

5267341



LOCK

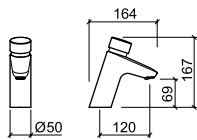

5530341

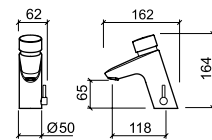

5535341

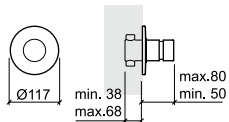

5532741

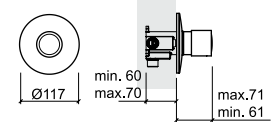

5531741

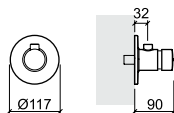

5530741

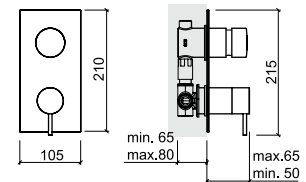

5536741

ECO

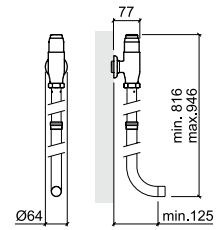

5190741

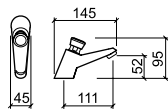

5190341

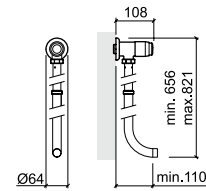

5190841

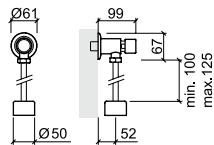

5190641

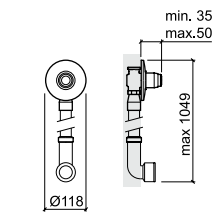

5191941

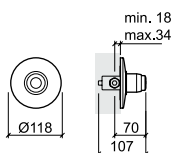

5190541

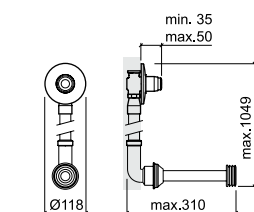

5190941

Torneiras eletrónicas
Electronic taps
Robinets électroniques
Grifos electrónicos





TUBE

Torneiras eletrônicas Electronic taps Robinets électroniques Grifos electrónicos



As torneiras eletrônicas com sensores garantem uma boa gestão água, já que minimizam o seu desperdício. Para além da poupança de água, satisfazem as mais elevadas exigências de higiene e conforto do utilizador.

O acionamento é feito sem contacto direto com a torneira, evitando a proliferação de microrganismos nocivos e contribuindo para a máxima higiene da casa de banho.

Existe uma variedade de soluções sendo possível escolher entre um sistema de alimentação a pilhas ou a transformador.

Como funciona?

O sensor deteta a presença de um utilizador em frente à torneira e envia o sinal para a válvula solenoide que inicia a saída de água. Na sua ausência a unidade eletrónica interrompe o fluxo.

Sensored electronic taps ensure good water management as they minimize waste. In addition to saving water they also meet the highest demands in terms of hygiene and user comfort.

They operate without direct human contact with the tap which avoids the proliferation of harmful micro-organisms and contributes to the cleanliness of the bathroom.

There are a variety of solutions. It is possible to choose between a battery powered system or mains electric via transformer.

How do they work?

The sensor-eye detects the user's hands and sends a signal to the solenoid valve which starts the water flow. The tap automatically stops when the user's hands are no longer detected.

Des robinets électroniques équipés de capteurs assurent une bonne gestion de l'eau, car ils minimisent le gaspillage. En plus d'économiser l'eau, ils répondent aux exigences les plus élevées en matière d'hygiène et de confort des utilisateurs.

Ils fonctionnent sans contact direct avec le robinet, ce qui empêche la prolifération de micro-organismes nocifs et contribue à une hygiène maximale dans la salle de bains.

Il existe plusieurs solutions et il est possible de choisir entre un système d'alimentation par batterie ou par transformateur.

Comment cela fonctionne-t-il ?

Le capteur détecte les mains de l'utilisateur devant le robinet et envoie un signal à l'électrovanne qui déclenche la sortie de l'eau. Le robinet s'arrête automatiquement lorsqu'il ne détecte plus les mains de l'utilisateur.

Los grifos electrónicos con sensores aseguran una buena gestión del agua, ya que minimizan los desperdicios. Además de ahorrar agua, cumplen con las más altas exigencias en cuanto a higiene y comodidad del usuario.

Funcionan sin contacto directo con el grifo, evitando la proliferación de microorganismos nocivos y contribuyendo a la máxima higiene del baño. Hay una variedad de soluciones y es posible elegir entre un sistema de alimentación por batería o transformador.

¿Cómo funciona?

El sensor detecta las manos del usuario frente al grifo y envía una señal a la válvula solenoide que abre la salida de agua. El grifo detiene automáticamente el flujo cuando ya no detecta las manos del usuario.





NOVEL



NEW



NEW

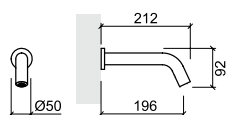

5147391  



NEW

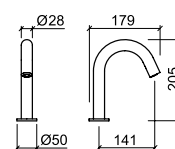

5146391  

SQUARE

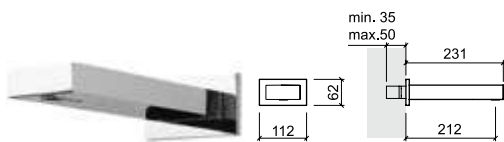

5477351  5477391 

TUBE

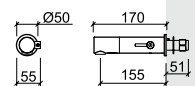
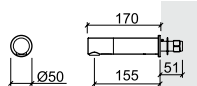

5317371 5317381 5317391 cx

5315381 5315391 cx

ADVANCE



NEW

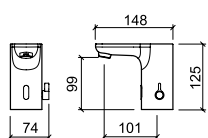

NEW

5270391  

WAVE



NEW

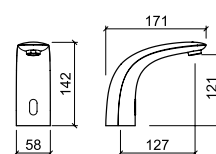

NEW

5156391 

TWOCARE



NEW

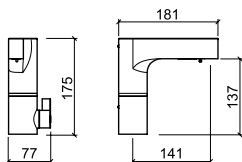

NEW

5070391

HERA

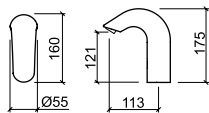

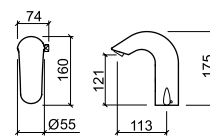

5406371  5406381 

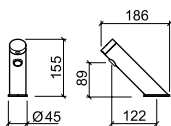

5400371  5400381 

BIO



5466371 

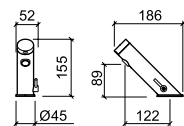

5460371 



BASIC

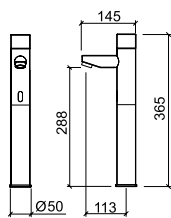

5427371 5427381

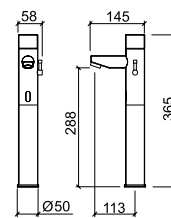

5424371 5424381

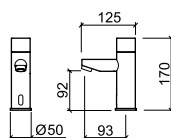

5426371 5426381

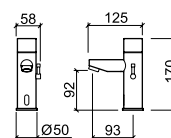

5420371 5420381

Torneiras eletrônicas
 Electronic taps
 Robinets électroniques
 Grifos electrónicos



UNIT

UNIT

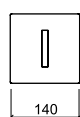

5410571

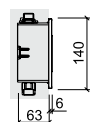

5410581

PLAN



5120571

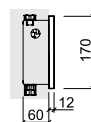

5120581

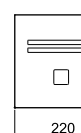
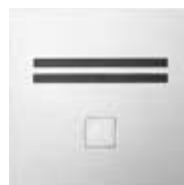

5120771

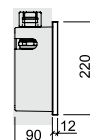

5120781

Torneira de coluna
Pillar tap
Robinet simple
Grifo



SIMPLE 30

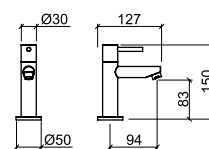

5100261

Acessórios para lavatórios
 Basins accessories
 Accessoires pour lavabos
 Accesorios para lavabos



[03] [12] [96] [B3]

NEW

4V31 TIC TAC



[11] [10] [16]

4V91 TIC TAC



4V92 TIC TAC



4V93 TIC TAC



4V94 TIC TAC



[03] [12] [96] [B3]

NEW

4V99



[03] [12] [96] [B3]

NEW

4V35



[11] [06]

NEW

4V95



4V96

Soluções para duche
Shower solutions
Solutions de douche
Soluciones de ducha





Tipos de jato Jet types Types de jet Tipos de chorro



Dependendo do modelo, na gama da Sanindusa encontra soluções de chuveiros com uma, duas ou três tipologias de jato: **chuva**, **chuva intensa** e **massagem regeneradora**. Escolha o que melhor se adapta às suas necessidades e preferências. Nos chuveiros de jato simples, a performance do fluxo é influenciada pelo número de saídas de água.

Depending on the model you can find in Sanindusa's range of products shower solutions with one, two or three jet types: **rain**, **hard rain** and **booster massage**. Choose the one that best suits your needs and preferences. Hand showers with one jet have their flow performance influenced by the number of water outlets.

Selon les modèles, la gamme Sanindusa propose plusieurs solutions de douche avec un, deux ou 3 typologies de jet: **pluie**, **pluie intense** et **massage régénérant**. Il vous suffit de choisir la qui s'adaptera le mieux à vos besoins et préférences. Dans les douches à jet unique, le débit est influencé par le nombre de sorties d'eau.

Según el modelo, en la gama Sanindusa podemos encontrar soluciones de ducha con un, dos o tres tipos de chorro: **lluvia**, **lluvia fuerte** y **masaje regenerador**. Elija el que mejor se adapte a sus necesidades y preferencias. En las duchas de mano con chorro simple, el rendimiento del flujo está influenciado por el número de salidas de agua.



chuva
rain
pluie
lluvia



chuva intensa
hard rain
pluie intense
lluvia fuerte



massagem regeneradora
booster massage
massage régénérant
masaje regenerador



NEW ÍCONE

Kits de douche
Shower kits
Kits douche
Kits de ducha

TORUS

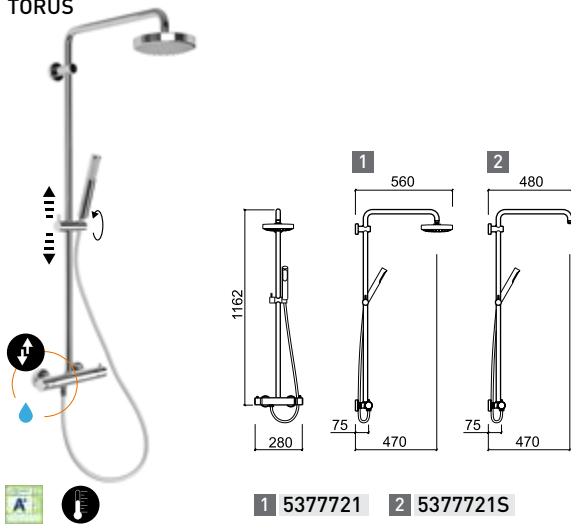

TUBE

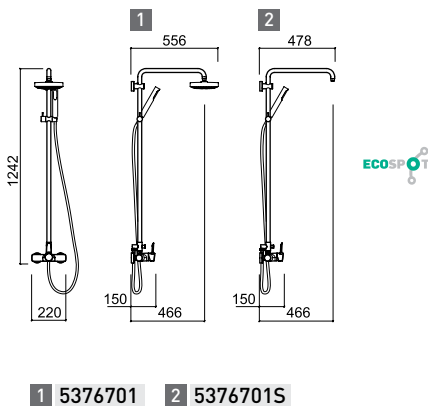
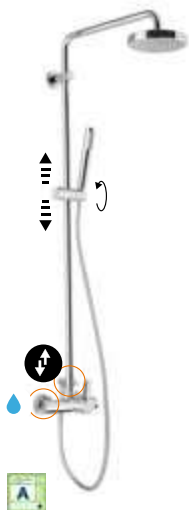
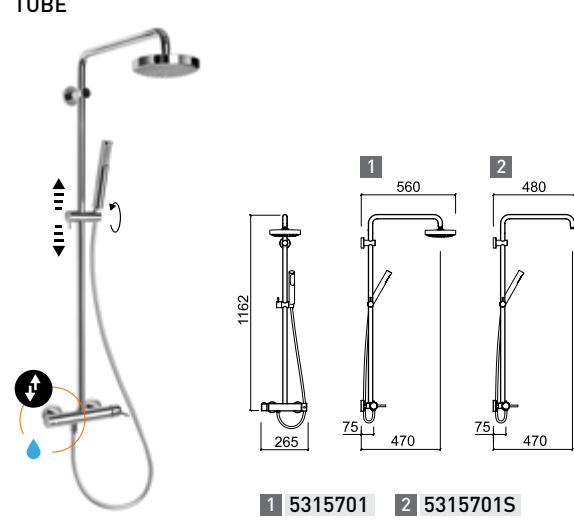

NEW ÍCONE

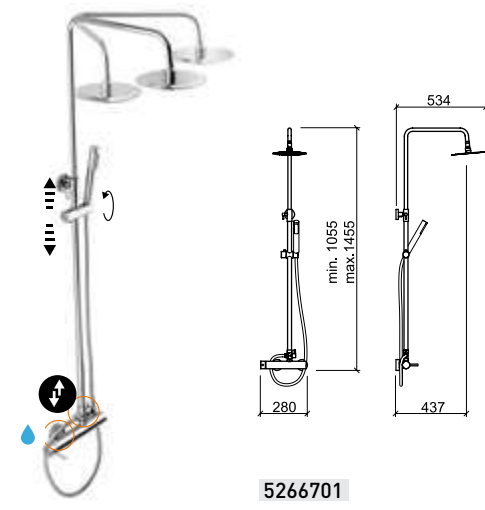

ADVANCE

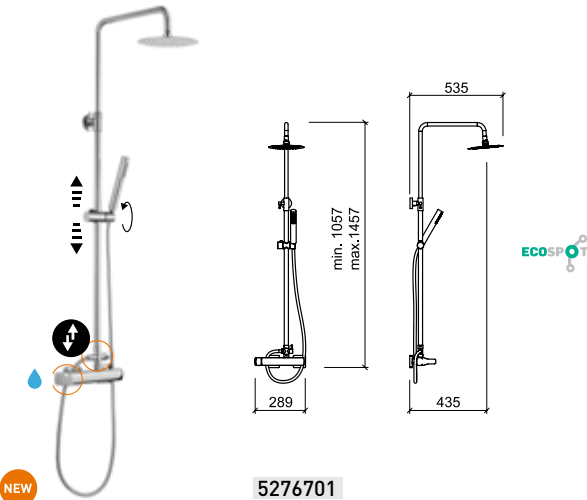

PLUS

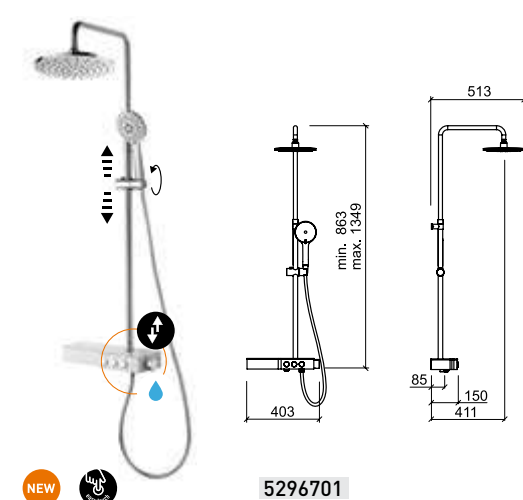

Kits de douche
 Shower kits
 Kits douche
 Kits de ducha

FACE

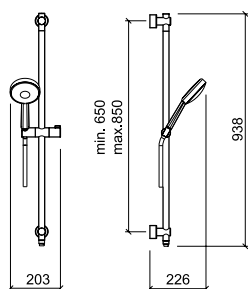
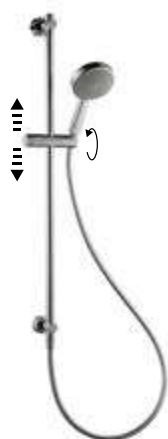

5R810701

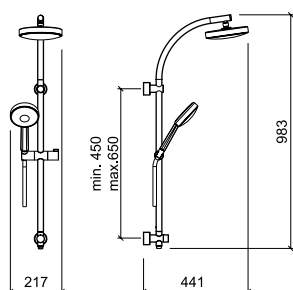
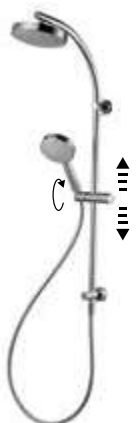

5R890701

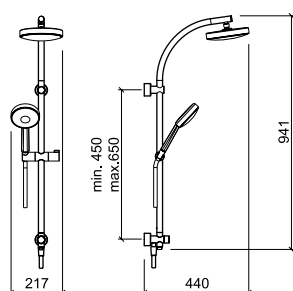
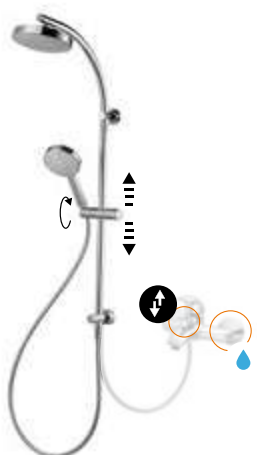

5R890801



FACE

NEW ÍCONE

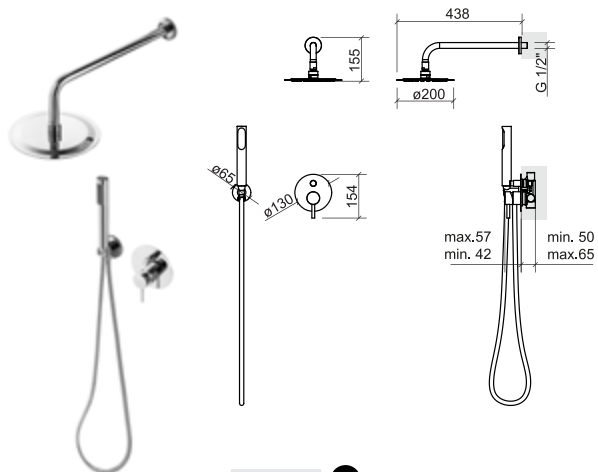

5269802 4V

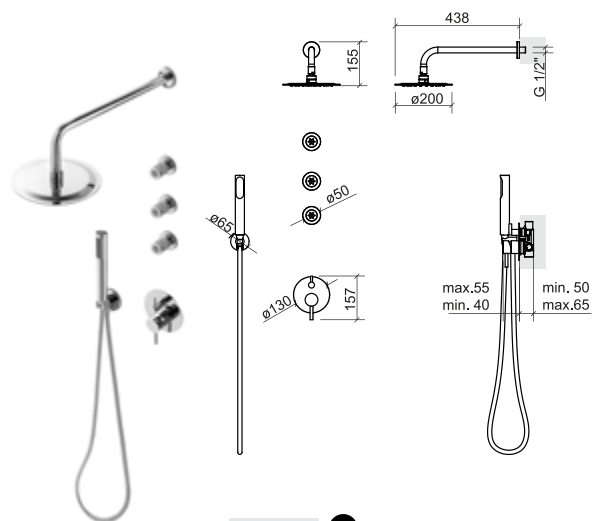

5269603 5V

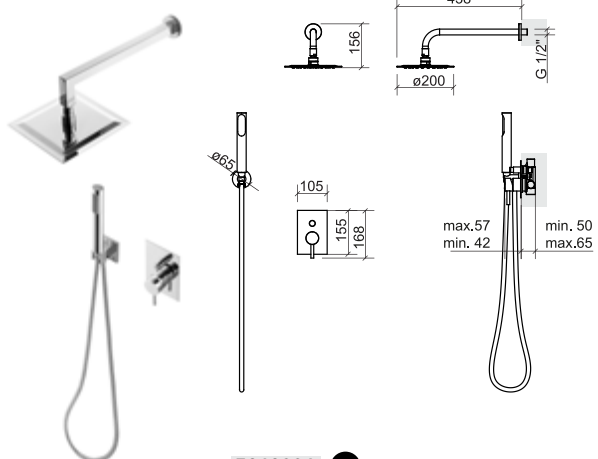

5269804 4V

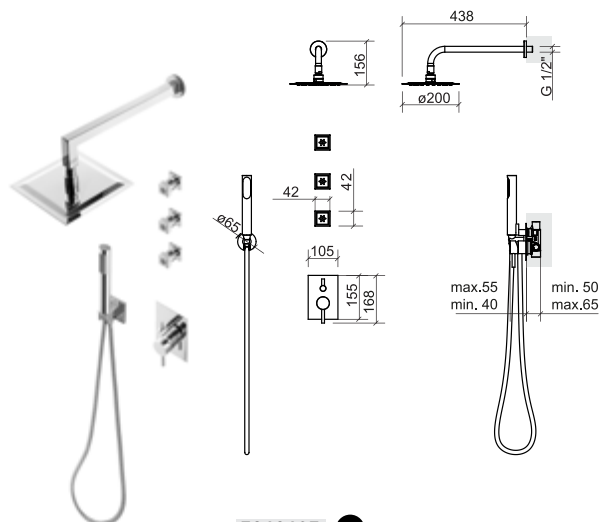

5269605 5V



MAIN CALL

Pinhas/hastes
Shower heads/arms
Douches de tête/bras
Cabezal ducha/barras

MAIN CALL

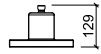

57792

FACE



58291

MAIN THERAPY

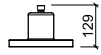

57592

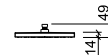

58691

ESSENZA

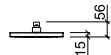

56290

EXTRA-LARGE



58591

ÁREA

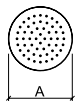

A
56291 ø200
56891 ø250
57691 ø300
57791 ø400

DUO

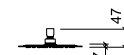
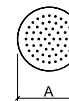
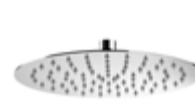

A
59391 ø200
59491 ø250
59791 ø300

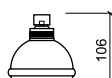

59995

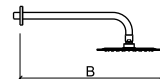

packs

	A	B	
5099335	ø200	440	☐
5099435	ø250	465	☐
5099735	ø300	490	☐

Pinhas/hastes
Shower heads/arms
Douches de tête/bras
Cabezal ducha/barras

QUADRA

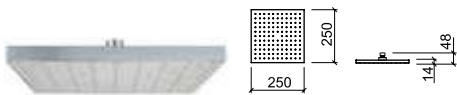

58791

ESSENZA

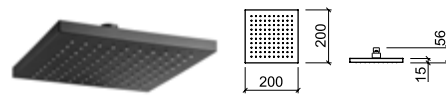

NEW

55990

HEADLINE

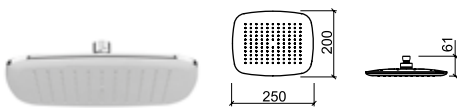

59091

SQUARE

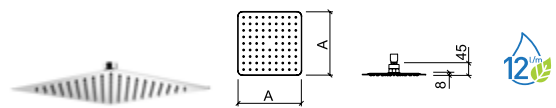

55991	A
56091	200
57491	250
57591	300
	400

ENJOY

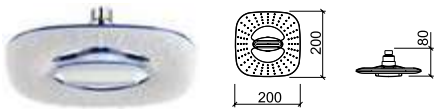

2

58892

PLAN

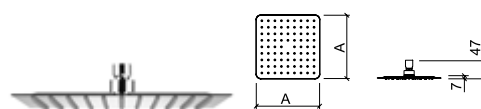

58091	A
58191	200
58991	250
	300

LOCK

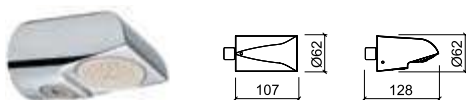

59996

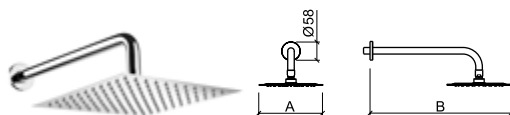

packs	5098035	A	B	
	5098135	200	440	
	5098935	250	465	
		300	490	



HEADLINE

Pinhas/hastes
 Shower heads/arms
 Douches de tête/bras
 Cabezal ducha/barras



ÁREA

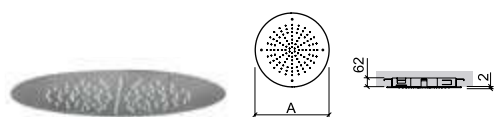

57291 A
 ø380
57391 ø498

SQUARE

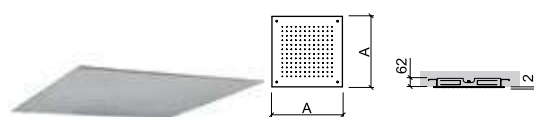

57091 A
 380
57191 498

KING

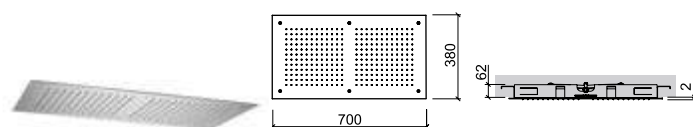

56591

Pinhas/hastes
Shower heads/arms
Douches de tête/bras
Cabecal ducha/barras



NEW

58070

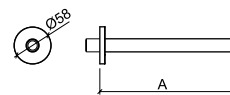

A

58010 108

58020 208

58030 308

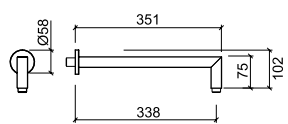

NEW

58080

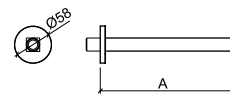

A

58040 108

58050 208

58060 308

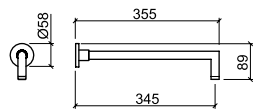

58000

Chuveiros de mão
 Hand showers
 Douchettes à main
 Duchas de mano



EXTRA-LARGE



EKO

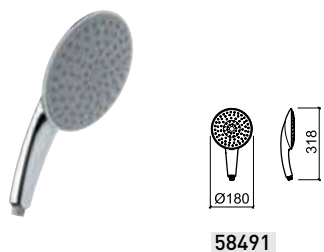

FACE

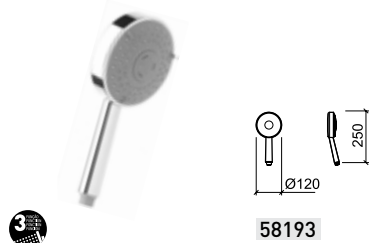

PLAN

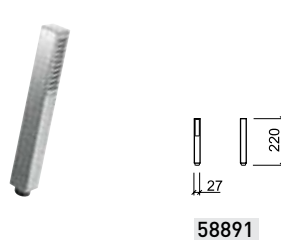

Chuveiros de mão
Hand showers
Douchettes à main
Duchas de mano



ONE

ALFA

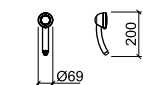

59692



DUO

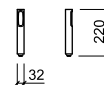

59691

BETA

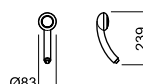

59093

PLAY

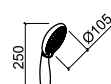

58092

SIGMA

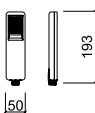

58391



ONE

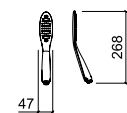

59591

PRO-JET

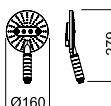

57893

DIGIT



59293

Chuveiros de mão
Hand showers
Douchettes à main
Duchas de mano

STAR



55893

OMEGA



59191

BASIC



54291

MIXA



59390

GRÉCIA

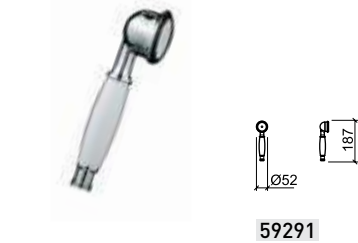

59291

AQUA



56691

SMILE



59191



Flexíveis de duche
 Shower hoses
 Flexibles de douche
 Flexibles de ducha



5A550320 150cm

5A550321 175cm



5A310320 150cm

5A310321 175cm



5A000321 175cm



Suportes e saídas de água
 Brackets and water outlets
 Supports et sorties d'eau
 Soportes y salidas de agua

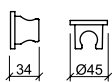

56902

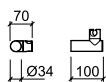

5A31010



5A00010

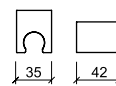

NEW

56900

Suportes e saídas de água
Brackets and water outlets
Supports et sorties d'eau
Soportes y salidas de agua

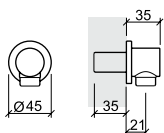

5A311801

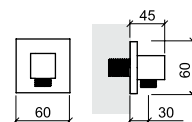

56901

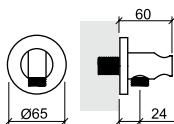

56904

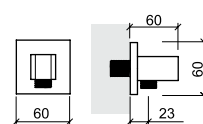

56903

ESSENZA

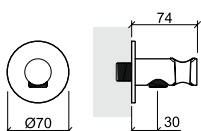

NEW

55904

ESSENZA

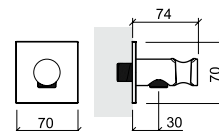

NEW

55903

Injetores de hidromassagem
Hydromassage jets
Jets d'hydromassage
Inyectores de hidromasaje



57891



57991



Rampas
Sliding rails
Barres de douche
Barras de ducha

STEP

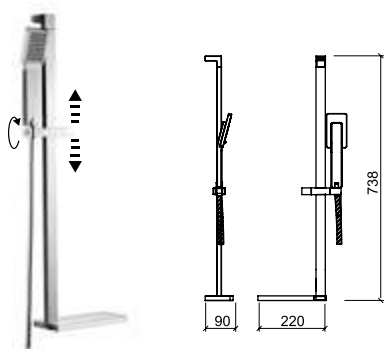

5R490701

BASIC

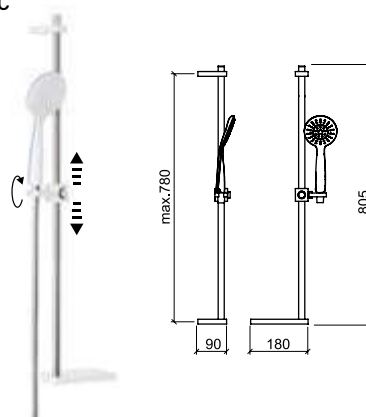

5R420701

PRO-JET

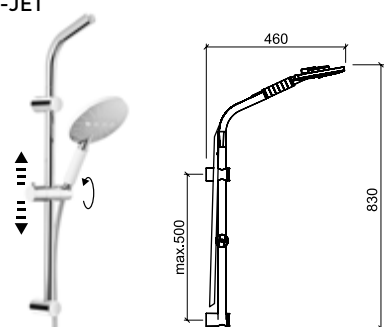

5R780701

EASY

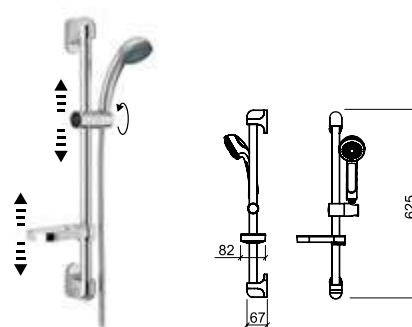

5R360701

Rampas
 Sliding rails
 Barres de douche
 Barras de ducha

PLAN

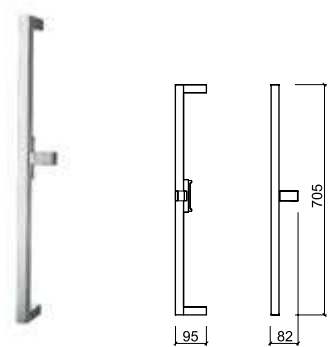

5R080701

DUO

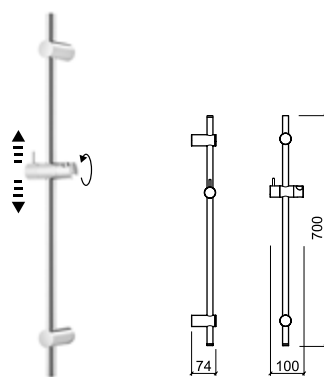

5R310711

ESSENZA

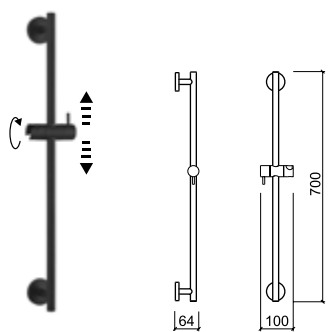

5R590701

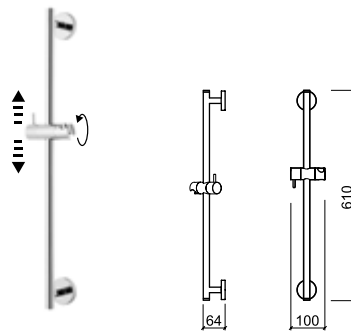

5R310701

NEW

ADVANCE

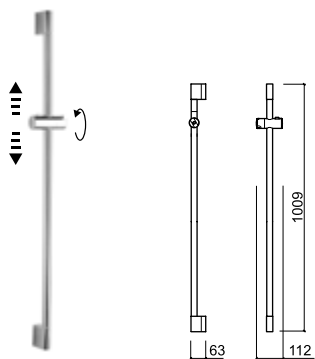

5R090701

ALFA PLUS

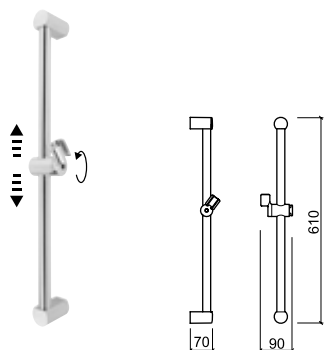

5R070701

Mini-misturadoras de duche
 Mini shower mixers
 Mini mitigeurs de douche
 Mini mezcladores de ducha



TUBE

MIXA

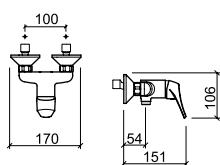

5207001 + kit aqua 

TUBE

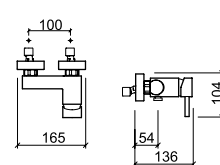

5317001 + kit aqua 



ACESSÓRIOS
ACCESSORIES
ACCESSOIRES
ACCESORIOS

Cerâmica

Ceramic
Céramique
Cerámica

464 Vintage

Inox

Stainless steel
Acier Inoxydable
Acero Inoxidable

466 Arc

467 Rimini

Latão

Brass
Laiton
Latón

468 WCA 

470 Prestige

472 Alfa

Hotelaria

For hotels
Pour hotellerie
Para hoteles

474 Luxe 

VINTAGE

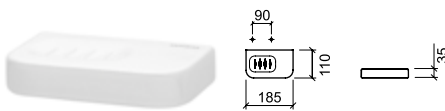

41700

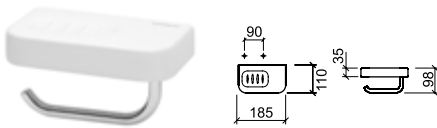

41721

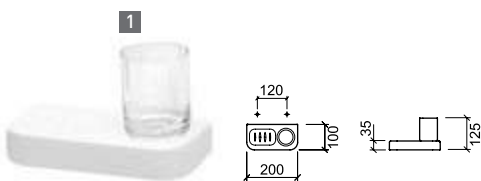

41713 **1** **6A8600**

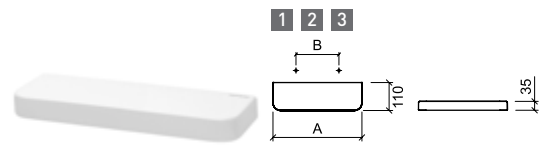

1 **2** **3**

	A	B
1 41704	185	90
2 41725	350	190
3 41727	600	400

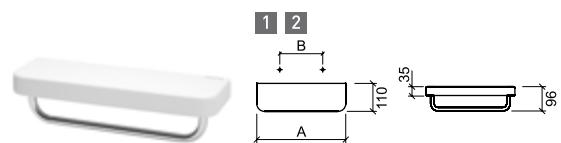

1 **2**

	A	B
1 41724	350	190
2 41726	600	400

VINTAGE

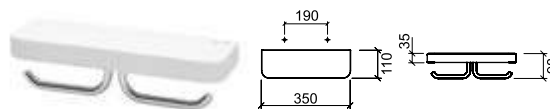

41723

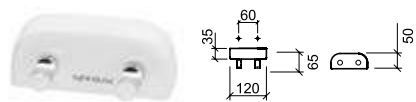

41703

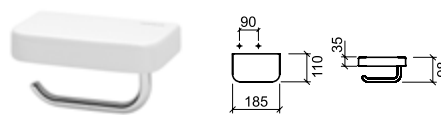

41710

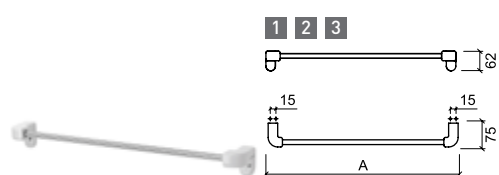

	A
1 41706	470
2 41707	570
3 41708	670

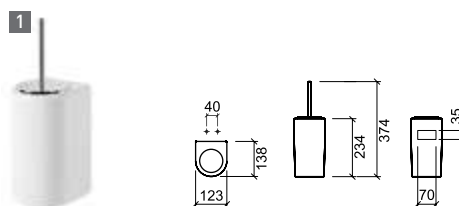

41719 1 41711

ARC

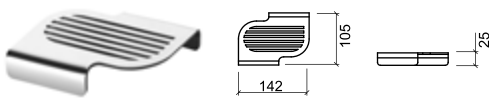
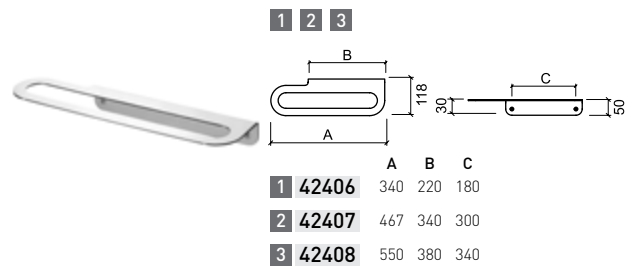

42402

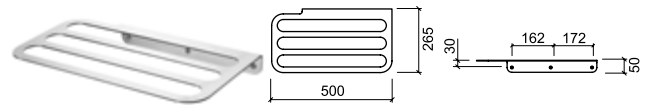

42424

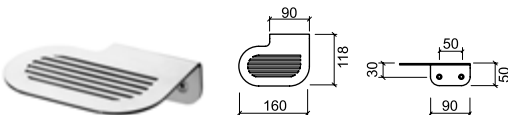

42400

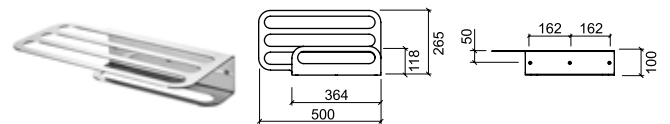

42414

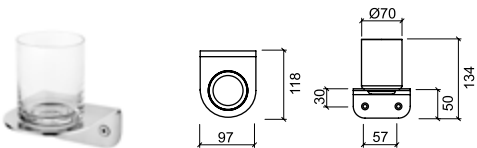

42417

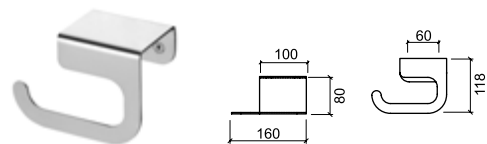

42410

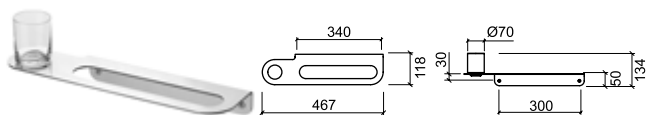

42413

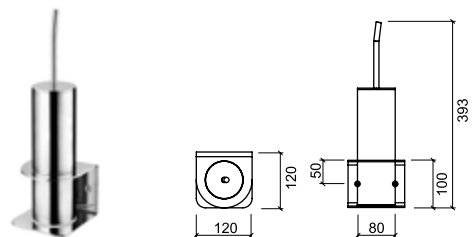

42421



41823

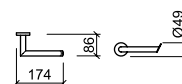

41810

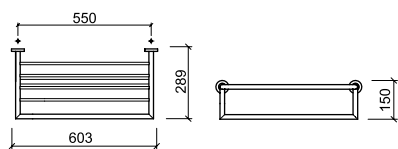

42114

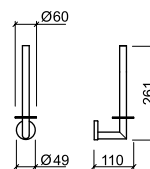

41820

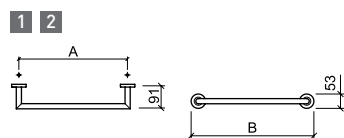

	A	B
1 41807	400	453
2 41808	550	603

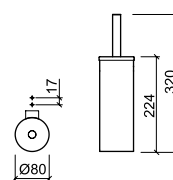

42109

WCA

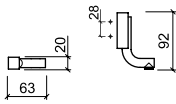

41300

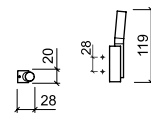

41303 *



Cores | Colours | Couleurs | Colores



cromado
chrome
chrome
cromo



*** dourado**
gold
doré
dorado

NEW



*** cobre**
copper
cuivre
cobre

NEW



*** níquel**
nickel
nickel
níquel

NEW



*** grafite**
graphite
graphite
grafito

NEW

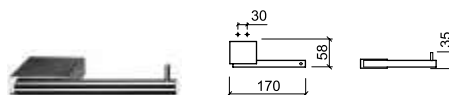

41310 *

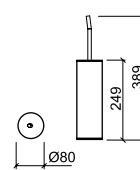

41309 *

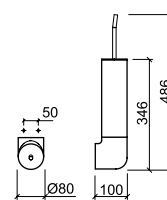

41319

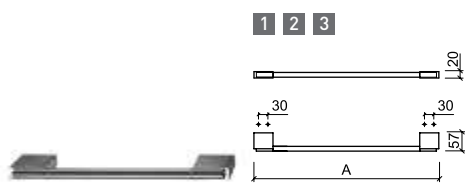

1 2 3

- | | A |
|---------|-------|
| 1 41306 | 300 |
| 2 41307 | 600 * |
| 3 41308 | 800 |

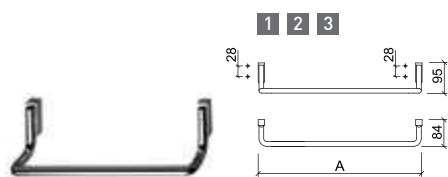

1 2 3

- | | A |
|---------|-----|
| 1 41326 | 300 |
| 2 41327 | 600 |
| 3 41328 | 800 |

PRESTIGE

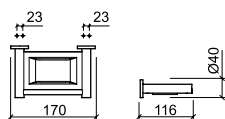

41100

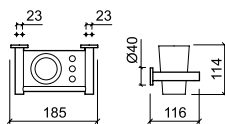

41116

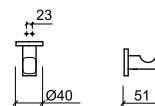

41103

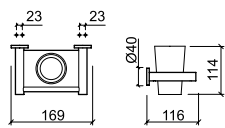

41113

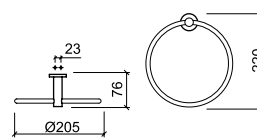

41115

PRESTIGE

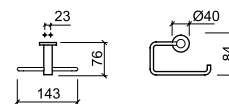
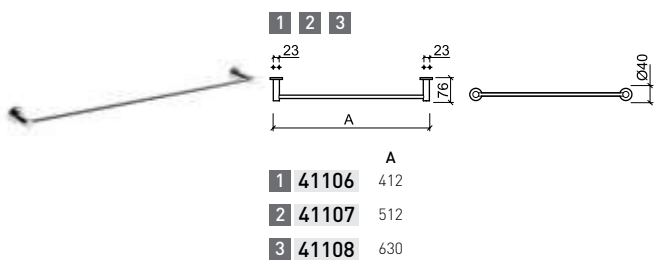

41110

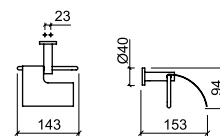
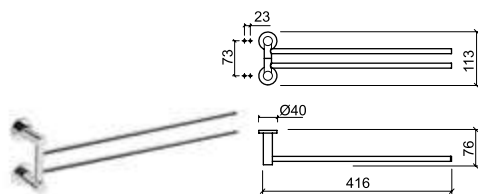

41120

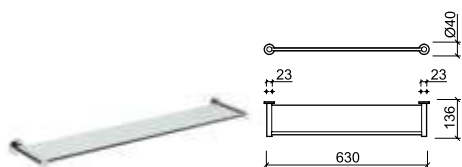

41104

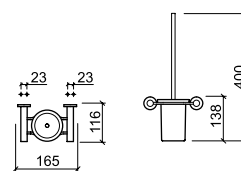

41109 1 41011

ALFA

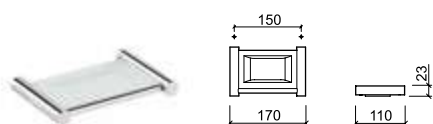

41000

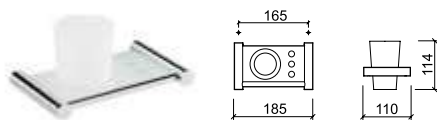

41016

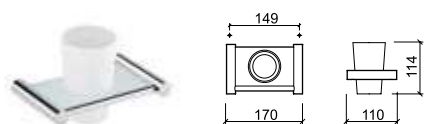

41013



41003

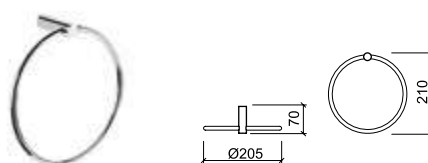

41015

ALFA

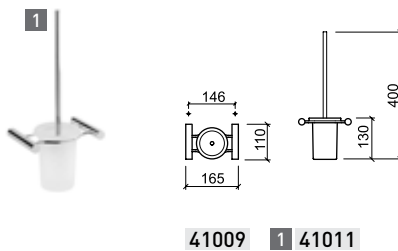
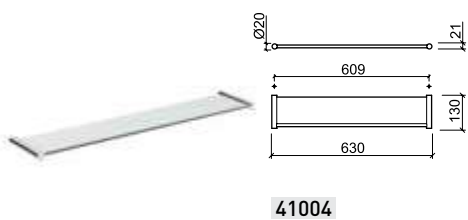
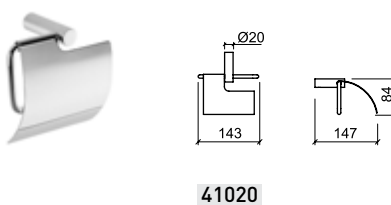
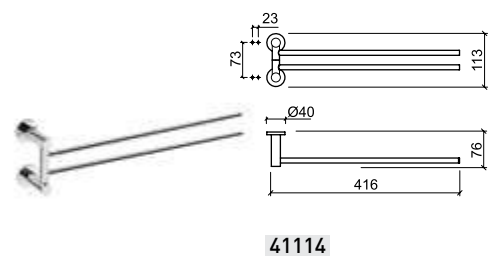
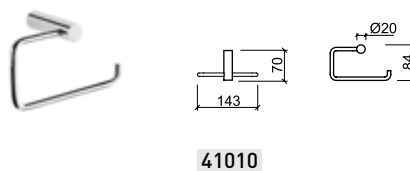
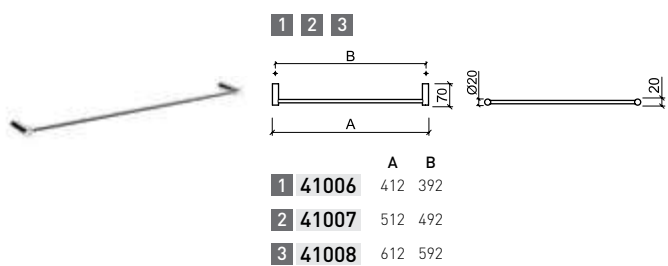

LUXE

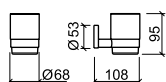

41513

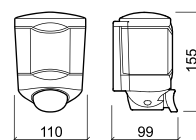

41539

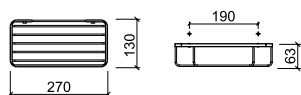

41501

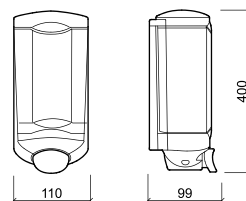

41540

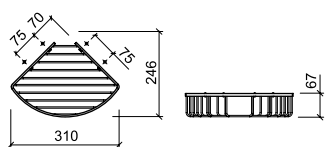

41502

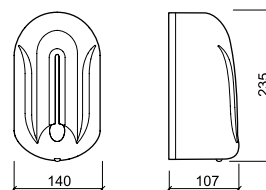

41537

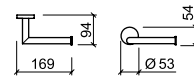

41510

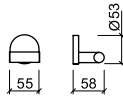

41523

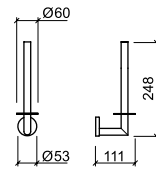

41511

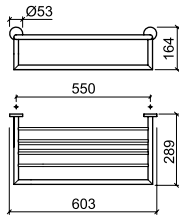

41514

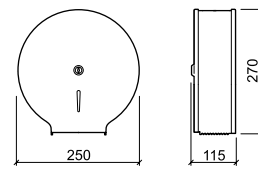

41544

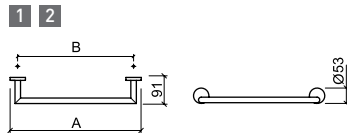

	A	B
1 41507	453	400
2 41508	603	550

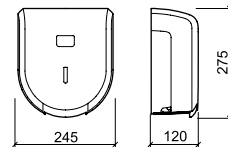

41543

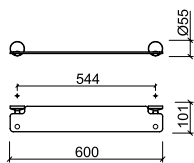

41504

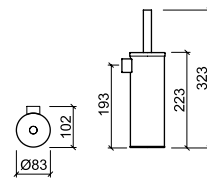

41509

LUXE



41542

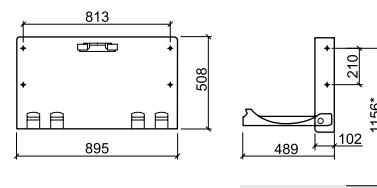

41557

NEW

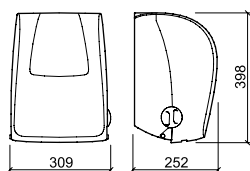

41549

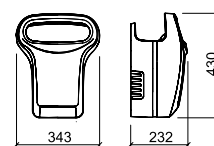

41532

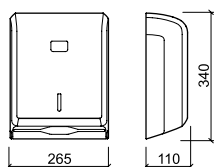

41541

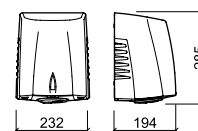

41555

LED

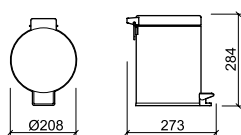

41522 *

NEW

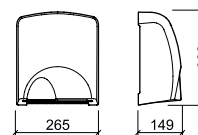

41534

Cores | Colours | Couleurs | Colores



* preto
black
noir
negro

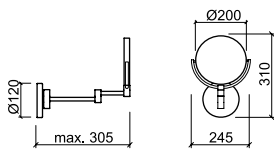

41545 *

NEW

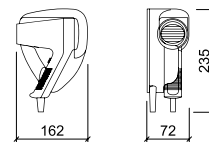

41535 1200W

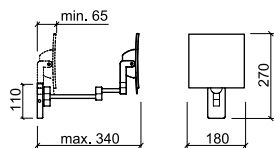

41546

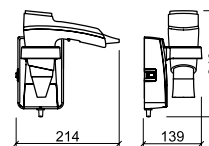

41536 1600W

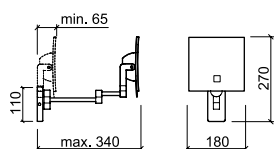

41547

LED

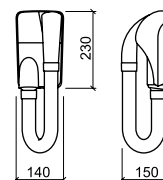

41556 * 1000W

NEW





COZINHA
KITCHEN
CUISINE
COCINA

Lava-louças
Kitchen sinks
Éviers
Fregaderos

- 480 Tribo
- 481 Reno NEW
- 482 Troia
- 483 Lusitano
- 484 Valet
- 488 Cuba & Plano
- 489 Belfast
- 490 Farmhouse NEW
- 492 Utility

Misturadoras
Mixers
Robinets
Grifos

- 494 Torus
- 496 Advance
- 497 Master 40
- 498 Alfa
- 499 Kopa Arc NEW
- 499 Kopa Square NEW
- 500 Mixa
- 501 Easy
- 502 Cetus Basic
- 503 Tube
- 504 Start

TRIBO

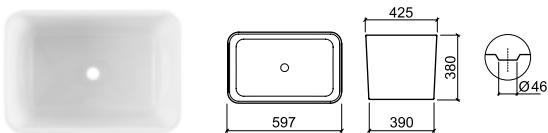

109900 4V99 

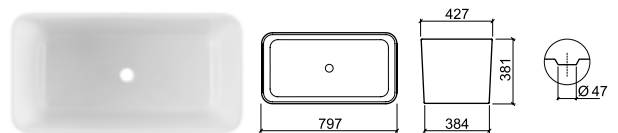

109910 4V99 

RENO

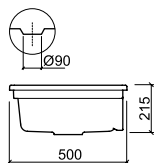
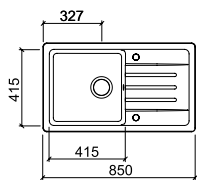

NEW

7313V 4701 

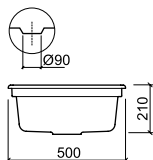
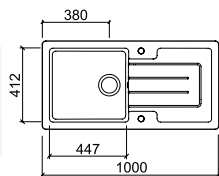

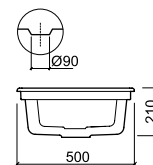
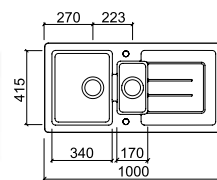

7310V 4701 

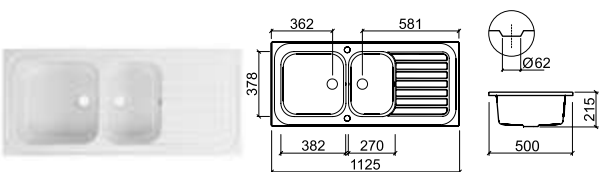

7311V 4703 

TROIA



7071 4707 

LUSITANO

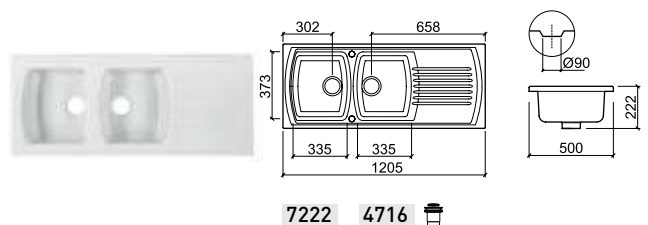
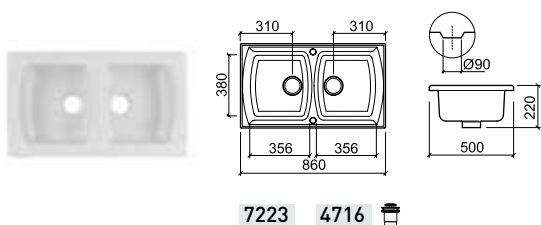
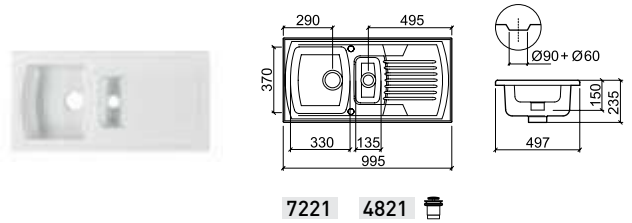
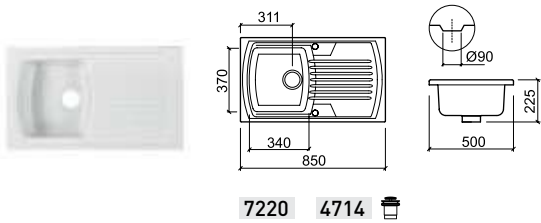



VALET

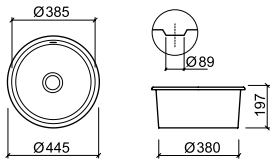

7380V 4701

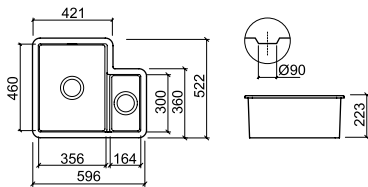

7360V 4704
4A360

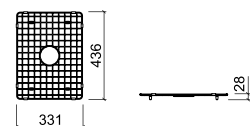
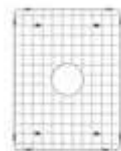

4A360

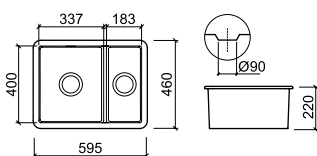

7370V 4704
4A370 4A330

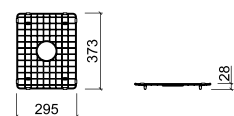
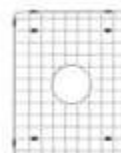

4A370

VALET

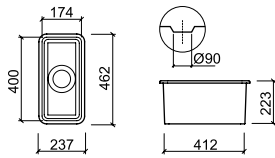

7330V 4701 4A330

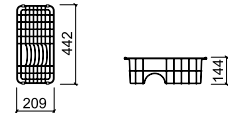

4A330

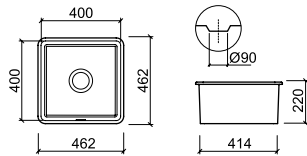

7340V 4701 4A340

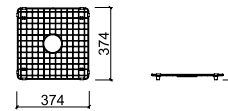
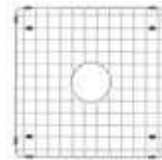

4A340

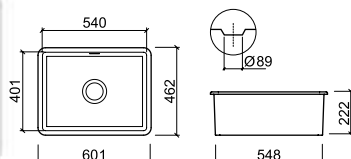

7350V 4701 4A350

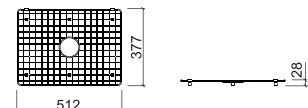
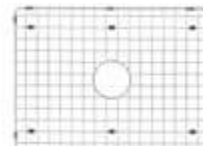

4A350



CUBA & PLANO

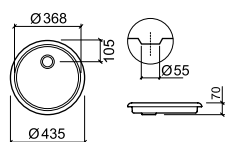

7210 4740 

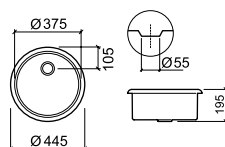

7200 4740 

BELFAST



Cores | Colours | Couleurs | Colores



branco
white
blanc
blanco

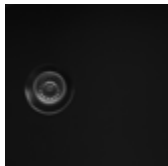

antracite mate
matte anthracite
anthracite mat
antracita mate

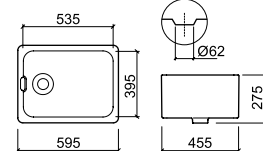

7400V 4730



FARMHOUSE

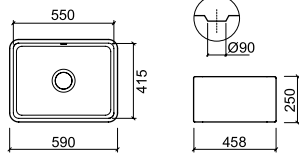

NEW

7404V 7405V 4701

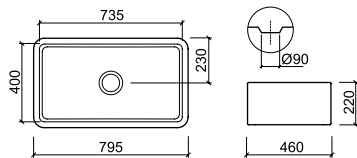

7401V 4701

4A401

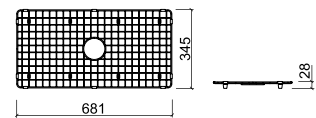
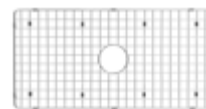

4A401

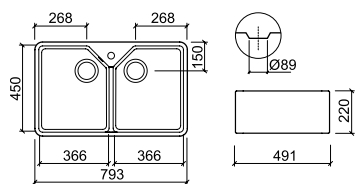

7403V 4704

4A413 4A403

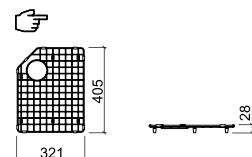
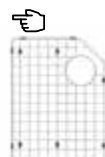

4A413 4A403

UTILITY

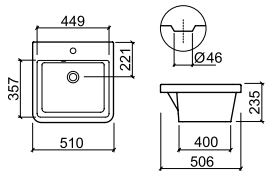

7410V 4V95 

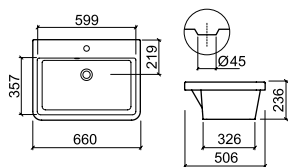

7411V 4V95 

Misturadoras de cozinha
Kitchen mixers
Robinets de cuisine
Grifos de cocina



TORUS

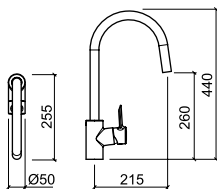

5373001

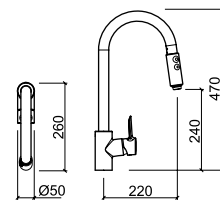

5373101



TORUS

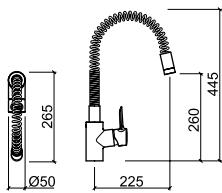

5374001

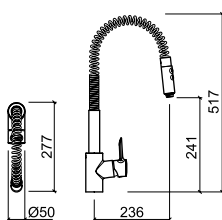

5374101

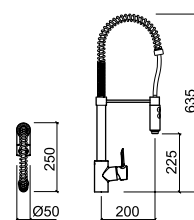

5374201



ADVANCE

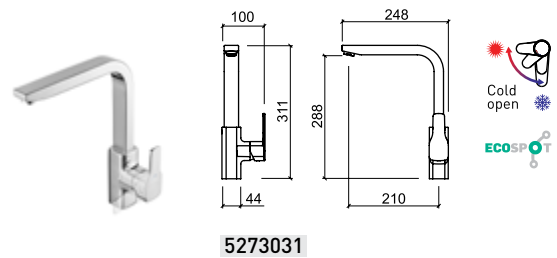
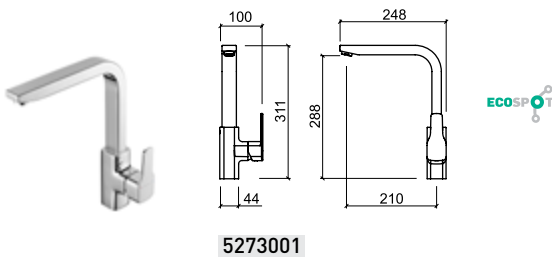

MASTER 40

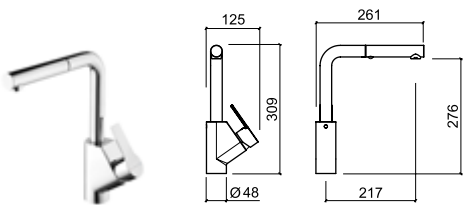

5253001

ALFA



5003001



5003101



5003201

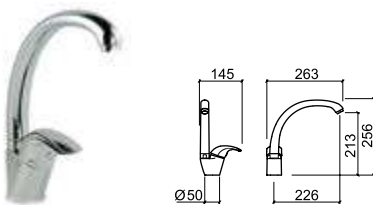

5003301

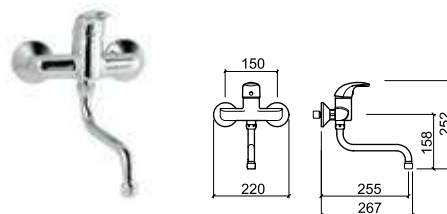

5003701

KOPA

NEW

Cores | Colours | Couleurs | Colores



inox escovado
brushed stainless steel
acier inoxydable brossé
acero inoxidable cepillado



dourado escovado
brushed gold
doré brossé
dorado cepillado



cobre escovado
brushed copper
cuivre brossé
cobre cepillado



KOPA ARC

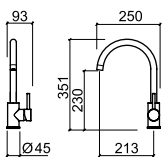

5134001

NEW

KOPA SQUARE

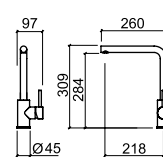

5133001

NEW

MIXA

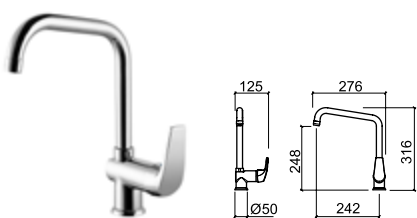

5203001

EASY

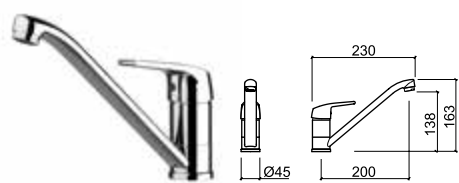

5363001

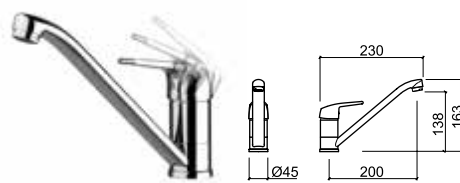

NF 5363001NF



CETUS BASIC

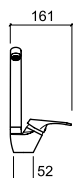

5573301

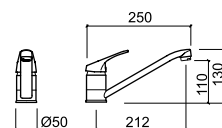
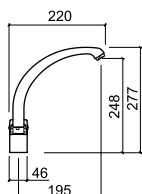

5573001

TUBE

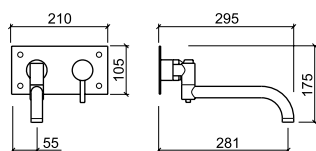





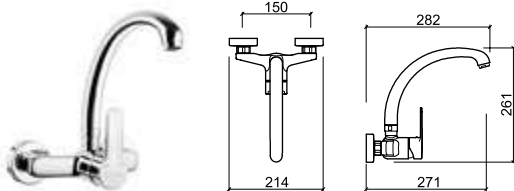

























5313001

START

























5583701

LOUÇA SANITÁRIA
SANITARY WARE
APPAREILS SANITAIRES
SANITARIOS

	novidade new nouveauté novedad		easyclip
	fechado atrás back to wall fermé à l'arrière cerrado por detrás		slim
	suspensão wall mounted suspendue suspendido		com 3 furos para torneira with 3 holes for mixer 3 trous pour robinet con 3 orificios para grifo
	entrada de água water supply entrée d'eau entrada de agua		encastrar por cima inset à encastrer par dessus encimera
	entrada de água lateral side water supply alimentation latérale entrada de agua lateral		pousar vessel à poser sobre encimera
	dupla descarga dual flush double chasse doble descarga		semi-encastrar semi recessed semi-encastré semiempotrados
	rimflush		parede wall mounted mural mural
	classificação hídrica water efficiency certification classification des eaux clasificación del agua		peso estático máximo maximum static weight charge statique maximum peso estático máximo
	certificação NF NF certification certification NF certificación NF		mobilidade reduzida reduced mobility mobilité réduite movilidad reducida
	fixação superior upper fixation fixation supérieure fijación superior		sénior senior senior senior
	fixação inferior lower fixation fixation inférieure fijación por debajo		peso estático máximo maximum static weight charge statique maximum peso estático máximo
	com furação para tampo with holes for cover avec percement pour abattant con orificio para tapa		pilha battery pile pila
	antibacteriano anti-bacterial antibactérien antibacteriano		transformador transformer transformateur transformador
	slowclose		marcação CE CE marking marquage CE marca CE
	clipoff		eletrónico electronic electronique electronico



LAVATÓRIOS
BASINS
VASQUES
LAVABOS

	novidade new nouveauté novedad		iluminação LED LED light éclairage LED iluminación LED
	encastrar por baixo undermount à encastrer par dessous bajo encimera		iluminação touch touch light éclairage tactile iluminación por contacto
	encastrar por cima inset à encastrer par dessus encimera		desembaciador demister anti-buée antivaho
	pousar vessel à poser sobre encimera		google home
	semi-encastrar semi recessed semi-encastré semiempotrados		ligação Bluetooth Bluetooth connection connexion Bluetooth conexión Bluetooth
	parede wall mounted mural mural		função chamada phone call function fonction appel función de llamada
	com 3 furos para torneira with 3 holes for mixer 3 trous pour robinet con 3 orificios para grifo		função música music function fonction musique función de música
	direita right droite derecha		encastrar por cima inset à encastrer par dessus encimera
	esquerda left gauche izquierda		pousar vessel à poser sobre encimera
	reversível reversible réversible reversible		semi-encastrar semi recessed semi-encastré semiempotrados
	certificação NF NF certification certification NF certificación NF		parede wall mounted mural mural

MÓVEIS
FURNITURE
MEUBLES
MUEBLES

	novidade new nouveauté novedad
	click
	smoove

PEÇAS ESPECIAIS
SPECIAL PIECES
PIÈCES SPÉCIALES
PIEZAS ESPECIALES

	sem água waterless sans eau sin agua
	entrada de água water supply entrée d'eau entrada de agua
	eletrónico electronic electronique electronico

MOBILIDADE REDUZIDA
REDUCED MOBILITY
MOBILITÉ RÉDUITE
MOVILIDAD REDUCIDA

- NEW** novidade
new
nouveauté
novedad
- entrada de água
water supply
entrée d'eau
entrada de agua
- entrada de água lateral
side water supply
alimentation latérale
entrada de agua lateral
- dupla descarga
dual flush
double chasse
doble descarga
- classificação hídrica
water efficiency certification
classification des eaux
clasificación del agua

- antiderrapante
anti-slip
antidérapant
antideslizante
- manípulo clínico
medical lever
levier médical
maneta clínica
- alavanca clínica
"joystick" lever
levier "joystick"
palanca clínica
- para sanita
for toilet
pour cuvette
para inodoro
- para urinol
for urinal
pour urinoir
para urinário

- direita
right
droite
derecha
- esquerda
left
gauche
izquierda
- válvula
waste
vidage
válvula
- painéis
panels
panneaux
paneles
- capacidade (l)
capacity (l)
capacité (l)
capacidad (l)

- esquerda
left
gauche
izquierda
- mobilidade reduzida
reduced mobility
mobilité réduite
movilidad reducida
- face não vidrada
unglazed side
surface non émaillée
lado no esmaltado
- válvula
waste
vidage
válvula
- certificação NF
NF certification
certification NF
certificación NF

- certificação NF
NF certification
certification NF
certificación NF
- sénior
senior
senior
senior
- antibacteriano
anti-bacterial
antibactérien
antibacteriano

INFANTIL
KIDS
ENFANTS
NIÑOS

- antibacteriano
anti-bacterial
antibactérien
antibacteriano
- capacidade (l)
capacity (l)
capacité (l)
capacidad (l)

BASES DE DUCHE
SHOWER TRAYS
RECEVEURS DE DOUCHE
PLATOS DE DUCHA

- NEW** novidade
new
nouveauté
novedad
- pousar
vessel
à poser
sobre encimera
- encastar
built-in
à encastrer
encimera

- 12
débito de água
water flow
débit d'eau
flujo de agua

COLUNAS DE HIDROMASSAGEM
HYDROMASSAGE COLUMNS
COLONNES D'HYDROMASSAGE
COLUMNAS DE HYDROMASAJE

- termostática
thermostatic
thermostatique
termostática

- slowclose

BANHEIRAS
BATHTUBS
BAIGNOIRES
BAÑERAS

- EASY sistema EASY
EASY system
système EASY
sistema EASY
- X90 sistema X90
X90 system
système X90
sistema X90
- TOP sistema TOP
TOP system
système TOP
sistema TOP

- extra-plana
extra-flat
extra-plat
extraplana
- corte à medida
cut to size
découpe sur mesure
corte a medida
- antiderrapante
anti-slip
antidérapant
antideslizante

DIVISÓRIAS
SHOWER SCREENS
PAROIS
MAMPARAS

- direita
right
droite
derecha
- esquerda
left
gauche
izquierda
- reversível
reversible
réversible
reversible

- ClipOff® clipoff
- parede
wall mounted
mural
mural
- 400KG peso estático máximo
maximum static weight
charge statique maximum
peso estático máximo

- direita
right
droite
derecha

- TWOSPACE sistema TWOSPACE
TWOSPACE system
système TWOSPACE
sistema TWOSPACE

- textura
textured
texture
textura

- esquerda
left
gauche
izquierda

- motor direito
right engine
moteur à droite
mотор derecho

- antibacteriano
anti-bacterial
antibactérien
antibacteriano

- encastar
built-in
à encastrer
encimera

- motor esquerdo
left engine
moteur à gauche
mотор izquierdo

- direita
right
droite
derecha

MISTURADORAS DE WC
BATHROOM MIXERS
ROBINETS DE SALLE DE BAINS
GRIFOS DE BAÑO



novidade
 new
 nouveauté
 novedad



castelos cerâmicos
 ceramic disk valve
 têtes de clapet céramique
 montura cerâmica



função chamada
 phone call function
 fonction appel
 función de llamada



novidade
 new
 nouveauté
 novedad

TIC TAC

válvula TIC TAC
 TIC TAC pop-up waste
 vidage TIC TAC
 válvula TIC TAC



sem chumbo
 without lead
 sans plomb
 sin plomo



função música
 music function
 fonction musique
 función de música



encastrar por baixo
 undermount
 à encastrer par dessous
 bajo encimera



válvula incluída
 waste included
 vidage inclus
 válvula incluída



para sanita
 for toilet
 pour cuvette
 para inodoro



cromoterapia
 chromotherapy
 chromothérapie
 cromoterapia



encastrar por cima
 inset
 à encastrer par dessus
 encimera



sénior
 senior
 senior
 senior



para urinol
 for urinal
 pour urinoir
 para urinário



certificação NF
 NF certification
 certification NF
 certificación NF



pousar
 vessel
 à poser
 sobre encimera



caudal
 flow rate
 débit
 caudal



para duche
 for shower
 pour douche
 para ducha

ACESSÓRIOS
ACCESSORIES
ACCESSOIRES
ACCESORIOS



grelha
 grid
 grille
 rejilla



coldopen
 Cold
 open



eletrónico
 electronic
 électronique
 electrónico



novidade
 new
 nouveauté
 novedad



escorridor
 dish drainer
 égouttoir
 escurridor



ecospot



transformador
 transformer
 transformateur
 transformador



iluminação LED
 LED light
 éclairage LED
 iluminación LED



sifão
 trap
 siphon
 sifón



com filtro
 with filter
 avec filtre
 con filtro



pilha
 battery
 pile
 pila



válvula
 waste
 vidage
 válvula



torneira
 tap
 robinet
 grifo



2 tipos de jato
 2 types of jet
 2 types de jet
 2 tipos de jet



direita
 right
 droite
 derecha



termostática
 thermostatic
 thermostatique
 termostática



3 tipos de jato
 3 types of jet
 3 types de jet
 3 tipos de jet



esquerda
 left
 gauche
 izquierda



3 vias
 3 way
 3 voies
 3 vías



easy touch



coldopen
 Cold
 open



4 vias
 4 way
 4 voies
 4 vías



chuveiro de mão
 hand shower
 douchette à main
 ducha de mano



ecospot



5 vias
 5 way
 5 voies
 5 vías



chuveiro de mão não incluído
 hand shower not included
 douchette à main non inclus
 ducha de mano no incluida



desviador
 diverter
 inverseur
 desviador



tempo de abertura
 opening time
 temps de débit
 tiempo de apertura



entrada de água
 water supply
 entrée d'eau
 entrada de agua



ligação Bluetooth
 Bluetooth connection
 connexion Bluetooth
 conexión Bluetooth

Os produtos apresentados seguem especificações técnicas internas da **Sanindusa**, baseadas nas normas internacionais em vigor.

As cores e dimensões das peças são meramente indicativas.

Os produtos fotografados podem não corresponder exatamente ao produto final devido ao conceito gráfico do catálogo.

Alguns acessórios presentes nos ambientes podem não estar disponíveis para a venda e/ou a **Sanindusa** não ser responsável pela sua venda e estão limitados ao stock existente.

A **Sanindusa** reserva o direito de fazer alterações técnicas que permitam melhorar a funcionalidade dos produtos, sem aviso prévio.

Consultar disponibilidade/prazo dos novos produtos antes de efetuar encomenda.

The presented products follow **Sanindusa's** internal technical specifications based on international standards.

The colours and dimensions of the products are merely indicative.

The photographed products may not correspond to the final product due to the catalogue's graphic concept.

Some accessories may not be available for sale and/or **Sanindusa** may not be responsible for them. Some accessories are limited to the available stock.

Sanindusa retains the right to perform technical changes to improve their product's functionality without prior notice.

Check the availability/delivery date of new products before ordering.

Les produits annoncés suivent les spécifications techniques internes de **Sanindusa** et se basent aux normes internationales en vigueur.

Les couleurs et dimensions des produits sont simplement indicatives.

Les produits photographiés peuvent ne pas correspondre exactement au produit final en raison du concept graphique du catalogue sous réserve de disponibilité.

Quelques accessoires présents dans les ambiances, peuvent ne pas être disponibles pour vente et/ou **Sanindusa** peut ne pas être responsable para sa vente.

Sanindusa se réserve le droit d'effectuer altérations techniques qui permettent améliorer la fonctionnalité des produits **Sanindusa**, sans notification préalable.

Consulter la disponibilité/délai des nouveaux produits avant de passer commande.

Los productos anunciados siguen las especificaciones técnicas internas de **Sanindusa**, que se basan en las normas internacionales vigentes.

Los colores y dimensiones del producto son meramente indicativos.

Los productos fotografiados pueden no corresponder exactamente al producto final debido al concepto gráfico del catálogo.

Algunos accesorios mostrados en los contextos pueden no estar disponibles para la venta y/o **Sanindusa** puede no ser responsable de su venta y se limitan al stock existente.

Sanindusa se reserva el derecho de realizar cambios técnicos que le permitan mejorar la funcionalidad de los productos **Sanindusa** sin previo aviso.

Compruebe la disponibilidad/fecha de entrega de los nuevos productos antes de hacer el pedido.

Sanindusa - Indústria de Sanitários S.A.
Zona Industrial Aveiro Sul
Apartado 43
3811-901 Aveiro
Portugal

Tel. +351 234 940 250
Fax +351 234 940 266
sanindusa@sanindusa.pt

© 2021



sanindusa
GRUPO



