



KITCHEN SINKS

ÉVIERS . LAVA-LOUÇAS



THE PATH OF WATER

SANINDUSA

KITCHEN SINKS

ÉVIERS . LAVA-LOUÇAS

DELTA 06

GEO 08

FARMHOUSE 10

BULTER 18

RENO 20

LUSITANO 28

VALET 36

BELFAST 52

TROIA 54

UTILITY 56

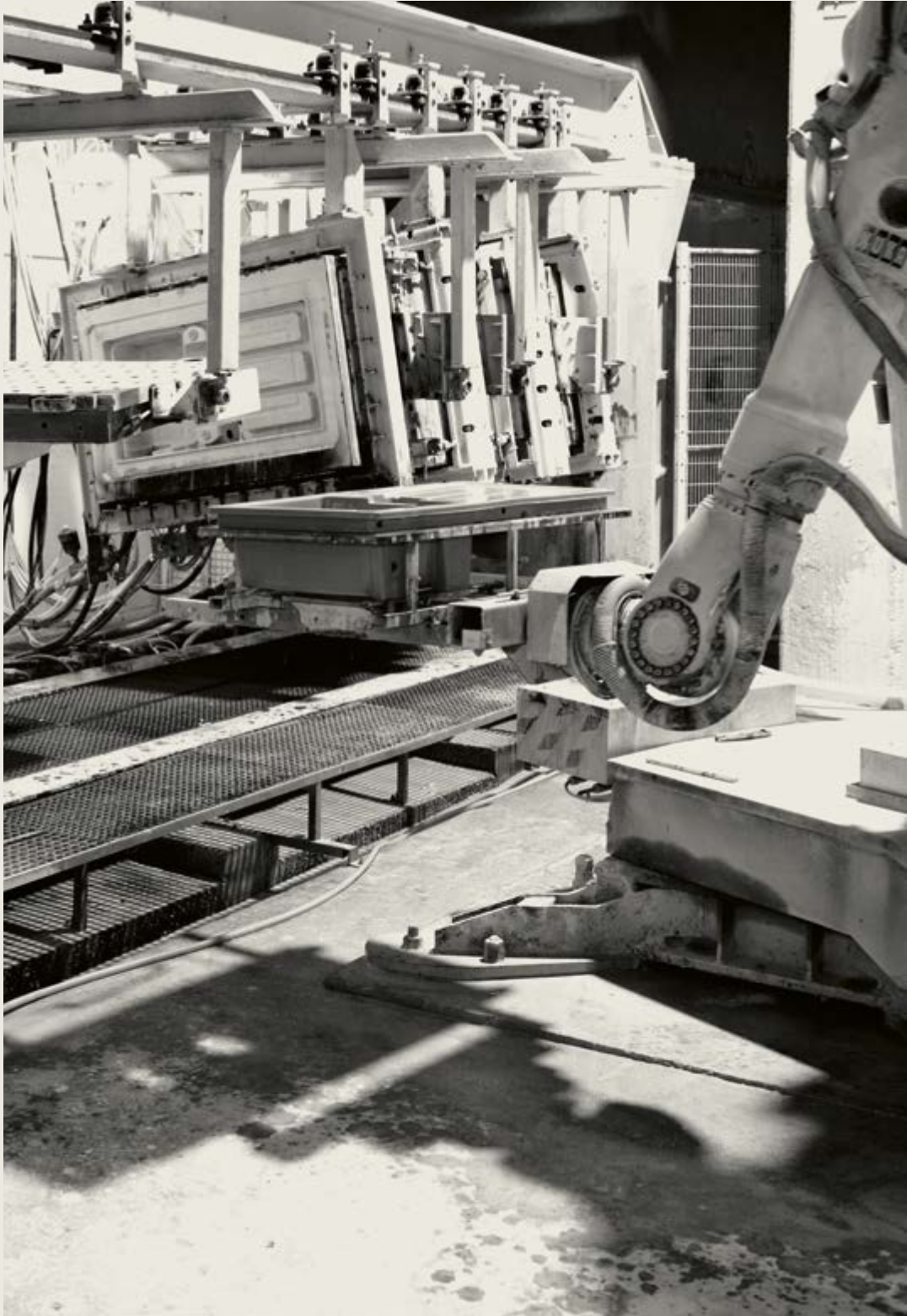

All Sanindusa kitchen sinks are produced in **fine fire-clay**, in a blend of 100% natural raw materials with antibacterial properties. They are coated with glaze and exposed to a high temperature oven (1220°C), making them **resistant to scratches and wear**. These products have a high durability and life span, even in situations of intensive use.

SINCE  1990

Tous les éviers Sanindusa sont produits en **fire-clay**, dans un mélange de matières premières 100% naturelles aux propriétés antibactériennes. Ces pièces sont revêtues d'une couche de verre et sont soumises à un four à haute température (1220°C), ce qui leur confèrent un **haut degré de résistance aux rayures et à l'usure**, en leur fournissant une longue durée de vie, même dans des situations d'utilisation intensive.

Todos os lava-louças da Sanindusa são produzidos em **fine fire-clay**, numa mistura de matérias-primas 100% naturais com propriedades antibacterianas. São revestidos com uma camada de vidro e sujeitos a elevadas temperaturas em forno de 1220°C, o que lhes confere um **elevado grau de resistência aos riscos e ao desgaste** e garante-lhes uma vida útil duradoura, mesmo em situações de uso intensivo.



RENO

7313

857 X 500 X 215 MM

Kitchen mixer
Mitigeur de cuisine . Misturadora de cozinha

TORUS . 537410111



ACID RESISTANT

- . Résistant aux acides
- . Resistente a ácidos

HEAT RESISTANT

- . Résistant à la chaleur
- . Resistente ao calor

IMPACT RESISTANT

- . Résistance aux chocs
- . Resistente a choques

SCRATCH AND STAIN RESISTANT

- . Résistant aux rayures et aux taches
- . Resistente a riscos e manchas

HYGIENIC AND SAFE FOR FOOD PREPARATION

- . Hygiénique et sûr pour la préparation des aliments
- . Higiénico e seguro a para preparação de alimentos

COLOUR STABILITY EVEN IN DIRECT SUNLIGHT EXPOSURE

- . Stabilité des couleurs également en cas d'exposition directe au soleil
- . Estabilidade de cor também em caso de exposição direta à luz solar



DELTA

7457

914 X 483 X 254 MM

Kitchen mixer
Mittigeur de cuisine . Misturadora de cozinha
KOPA SQUARE . 513300113

Fireclay sink.
Evier en Céramique.
Lava-Louça em Fireclay

Available with overflow
Disponible avec trop-plein
Disponível com overflow

DELTA



7457

PRODUCT DIMENSIONS

DIMENSIONS DU PRODUIT . DIMENSÕES DO PRODUTO

Overall dimension Dimension totale . Dimensão total	Length Longueur . Comprimento	914 mm
	Width Largeur . Largura	483 mm
	Height Hauteur . Altura	254 mm
Internal sink size Dimension de l'évier . Dimensão da cuba	Length Longueur . Comprimento	874 mm
	Width Largeur . Largura	397 mm
	Bowl depth Profondeur . Profundidade	220 mm

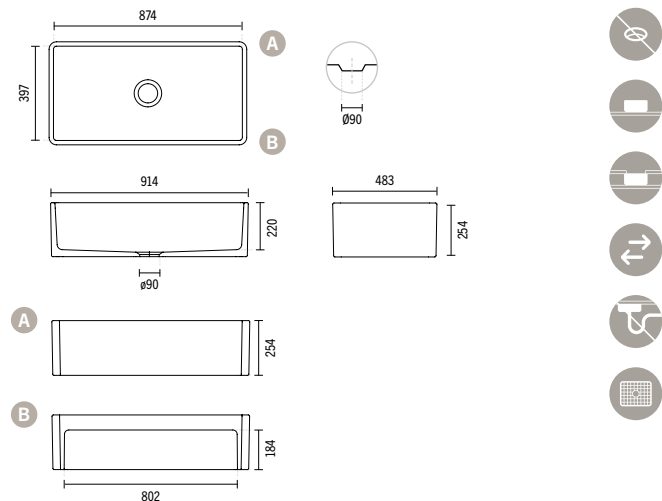

ACCESSORIES

ACCESSOIRES . ACESSÓRIOS

Grid in stainless steel

Grille en inox . Grelha em aço inoxidável

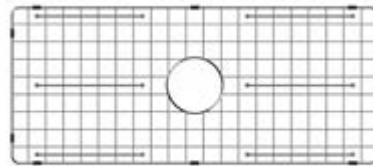

4A45

838x360x30 mm

AVAILABLE COLOURS

COULEURS DISPONIBLES . CORES DISPONÍVEIS



White
Blanc . Branco



Textured matt white
Blanc Mat Texturé . Branco mate texturado
Available soon . Bientôt disponible
Brevemente disponível

Sink without overflow

Évier disponible sans trop-plein . Lava-louça sem overflow

U-trap compatible Ref. 4701

Siphon compatible Ref. 4701 . Sifão compatível Ref. 4701



Without tap hole
Sans percement pour robinetterie
Sem furo para torneira



Countertop
Poser
Pousar



Apron Front
Evier à poser sous plan
Pousar abaixo do nível da bancada



Reversible
Réversible
Reversível



U-trap not included
Siphon en U non inclus
Sifão não incluído



Grid
Grille
Grelha



GEO

7443

838 X 484 X 254 MM

Kitchen mixer
Misturadora de cozinha . Mitigeur de cuisine
KOPA SQUARE . 513300129

Fireclay sink.
Evier en Céramique.
Lava-Louça em Fireclay

GEO

Available with overflow
Disponible avec trop-plein
Disponível com overflow



1 7440 . 2 7441 . 3 7442 . 4 7443 . 5 7444

PRODUCT DIMENSIONS

DIMENSIONS DU PRODUIT . DIMENSÕES DO PRODUTO

		1 24	2 27	3 30	4 33	5 36
Overall dimension Dimension totale . Dimensão total	A Length Longueur . Comprimento	609 mm	686 mm	762 mm	838 mm	914 mm
	B Width Largeur . Largura	484 mm	484 mm	484 mm	484 mm	484 mm
	C Height Hauteur . Altura	254 mm	254 mm	254 mm	254 mm	254 mm
Internal sink size Dimension de l'évier . Dimensão da cuba	D Length Longueur . Comprimento	558 mm	635 mm	711 mm	787 mm	863 mm
	E Width Largeur . Largura	433 mm	433 mm	433 mm	433 mm	433 mm
	F Bowl depth Profondeur . Profundidade	233 mm	233 mm	233 mm	233 mm	233 mm

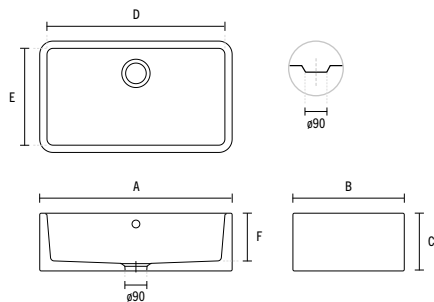

ACCESSORIES

ACCESSOIRES . ACESSÓRIOS

Grid in stainless steel

Grille en acier inoxydable . Grelha em aço inoxidável

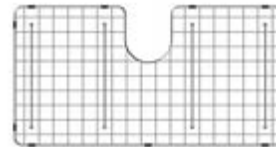

4A432 . 4A433

650x372x30 mm . 726x372x30 mm

AVAILABLE COLOURS

COULEURS DISPONIBLES . CORES DISPONÍVEIS



White
Blanc . Branco

Sink without overflow

Évier sans trop-plein . Lava-louça sem overflow

U-trap compatible Ref. 4701

Siphon compatible Ref. 4701 . Sifão compatível Ref. 4701



Without tap hole
Sans percement pour robinetterie
Sem furo para torneira



Countertop
Poser
Pousar



Apron Front
Evier à poser sous plan
Pousar abaixo do nível da bancada



U-trap not included
Siphon en U non inclus
Sifão não incluído



Grid
Grille
Grelha



FARMHOUSE

7401V

795 X 460 X 220 MM

Kitchen mixer
Mistigador de cozinha / Misturadora de cozinha
TORUS . 537420111



FARMHOUSE

7404V

590 X 458 X 250 MM

Kitchen mixer
Mitigeur de cuisine . Misturadora de cozinha

KOPA ARC . 513400113

Fireclay sink.
Evier en Céramique.
Lava-Louça em Fireclay

Available without overflow
Disponible sans trop-plein
Disponível sem overflow

FARMHOUSE



7404V

PRODUCT DIMENSIONS

DIMENSIONS DU PRODUIT . DIMENSÕES DO PRODUTO

Overall dimension Dimension totale . Dimensão total	Length Longueur . Comprimento	590 mm
	Width Largeur . Largura	458 mm
	Height Hauteur . Altura	250 mm
Internal sink size Dimension de l'évier . Dimensão da cuba	Length Longueur . Comprimento	550 mm
	Width Largeur . Largura .	415 mm
	Bowl depth Profondeur . Profundidade	230 mm

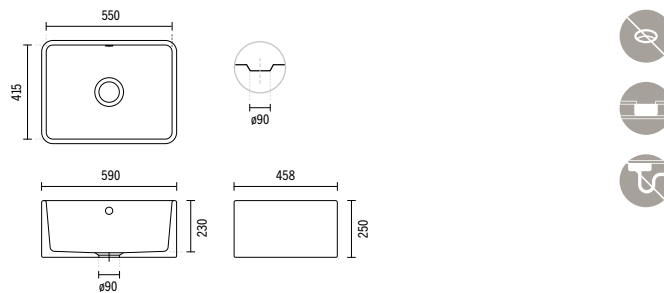

AVAILABLE COLOURS

COULEURS DISPONIBLES . CORES DISPONÍVEIS

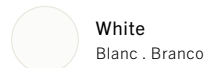

Waste included Ø90 Ref.4738
Vidage inclus Ø90 Ref.4738
Válvula incluída Ø90 Ref.4738
U-trap compatible Ref. 4701
Siphon compatible Ref.4701
Sifão compatível Ref. 4707



7401V

PRODUCT DIMENSIONS

DIMENSIONS DU PRODUIT . DIMENSÕES DO PRODUTO

Overall dimension Dimension totale . Dimensão total	Length Longueur . Comprimento	795 mm
	Width Largeur . Largura	460 mm
	Height Hauteur . Altura	220 mm
Internal sink size Dimension de l'évier . Dimensão da cuba	Length Longueur . Comprimento	735 mm
	Width Largeur . Largura	400 mm
	Bowl depth Profondeur . Profundidade	195 mm

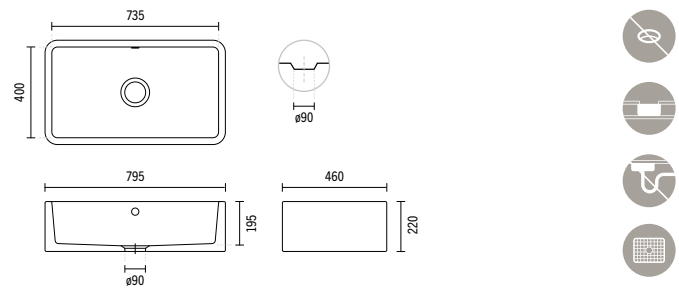

AVAILABLE COLOURS

COULEURS DISPONIBLES . CORES DISPONÍVEIS



ACCESSORIES

ACCESSOIRES . ACESSÓRIOS

Grid in stainless steel
Grille en inox . Grelha em aço inoxidável

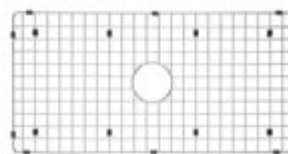

4A401

681x345x28 mm

Waste included Ø90 Ref.4738
Vidage inclus Ø90 Ref.4738
Válvula incluída Ø90 Ref.4738
U-trap compatible Ref. 4701
Siphon compatible Ref.4701
Sifão compatível Ref. 4701

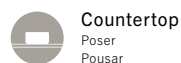
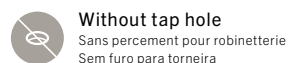





FARMHOUSE



7403V

793 X 491 X 220 MM

Kitchen mixer
Mistigeur de cuisine : Misturadora de cozinha
KOPA ARC . 513400129



FARMHOUSE

7402V

890 X 456 X 220 MM

Kitchen mixer
Mitigeur de cuisine . Misturadora de cozinha

KOPA ARC . 513400129

Fireclay sink.
Evier en Céramique.
Lava-Louça em Fireclay

Available without overflow
Disponível sans trop-plein
Disponível sem overflow

FARMHOUSE



7402V

PRODUCT DIMENSIONS

DIMENSIONS DU PRODUIT . DIMENSÕES DO PRODUTO

Overall dimension Dimension totale . Dimensão total	Length Longueur . Comprimento	890 mm
	Width Largeur . Largura	456 mm
	Height Hauteur . Altura	220 mm
Internal sink size Dimension de l'évier . Dimensão da cuba	Length Longueur . Comprimento	411 411 mm
	Width Largeur . Largura	415 mm
	Bowl depth Profondeur . Profundidade	195 mm

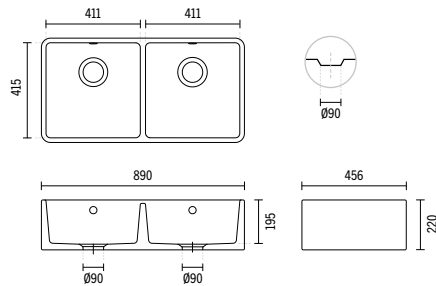

AVAILABLE COLOURS

COULEURS DISPONIBLES . CORES DISPONÍVEIS



Waste included Ø90 Ref.4704
Vidage inclus Ø90 Ref.4704
Válvula incluída Ø90 Ref.4704
U-trap compatible Ref. 470400
Siphon compatible Ref.470400
Sifão compatível Ref. 470400



7403V

PRODUCT DIMENSIONS

DIMENSIONS DU PRODUIT . DIMENSÕES DO PRODUTO

Overall dimension Dimension totale . Dimensão total	Length Longueur . Comprimento	793 mm
	Width Largeur . Largura	491 mm
	Height Hauteur . Altura	220 mm
Internal sink size Dimension de l'évier . Dimensão da cuba	Length Longueur . Comprimento	366 366 mm
	Width Largeur . Largura	450 mm
	Bowl depth Profondeur . Profundidade	195 mm

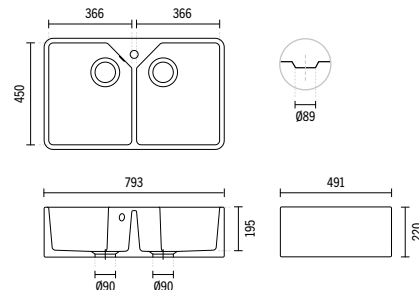

AVAILABLE COLOURS

COULEURS DISPONIBLES . CORES DISPONÍVEIS

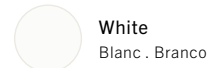

ACCESSORIES

ACCESSOIRES . ACESSÓRIOS

Grid in stainless steel
Grille en inox . Grelha em aço inoxidável

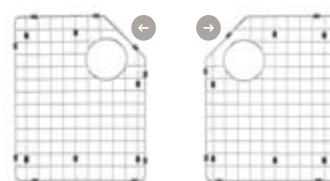

4A413

405x321x28 mm

4A403

405x321x28 mm

Waste included Ø90 Ref.4704
Vidage inclus Ø90 Ref.4704
Válvula incluída Ø90 Ref.4704
U-trap compatible Ref. 470400
Siphon compatible Ref.470400
Sifão compatível Ref. 470400

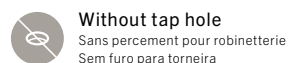



BUTLER

7500
597 X 630 X 220 MM

Kitchen mixer
Mitigeur de cuisine . Misturadora de cozinha
TORUS . 537410111

Fireclay sink.
Evier en Céramique.
Lava-Louça em Fireclay

Available without overflow
Disponible sans trop-plein
Disponível sem overflow



BUTLER

7500

PRODUCT DIMENSIONS

DIMENSIONS DU PRODUIT . DIMENSÕES DO PRODUTO

Overall dimension Dimension totale . Dimensão total	Length Longueur . Comprimento	597 mm
	Width Largeur . Largura	630 mm
	Height Hauteur . Altura	220 mm
Internal sink size Dimension de l'évier . Dimensão da cuba	Length Longueur . Comprimento	531 mm
	Width Largeur . Largura	441 mm
	Bowl depth Profondeur . Profundidade	191 mm

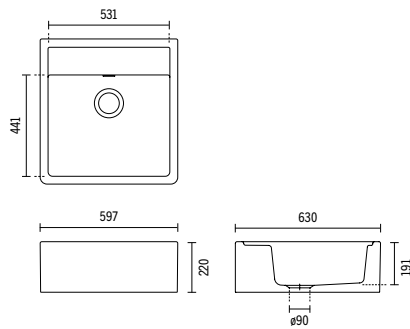

AVAILABLE COLOURS

CORES DISPONÍVEIS . COULEURS DISPONIBLES



White
Blanc . Branco

U-trap compatible Ref. 4701

Siphon compatible Ref.4701 . Sifão compatível Ref. 4701



Without tap hole
Sans percement pour robinetterie
Sem furo para torneira



Apron Front
Evier à poser sous plan
Pousar abaixo do nível da bancada



Countertop
Poser
Pousar



RENO



7310

1000 X 500 X 210 MM

Kitchen mixer
Mitageur de cuisine . Misturadora de cozinha
TORUS . 537400111



RENO

7310

1000 X 500 X 210 MM

Kitchen mixer
Mitigeur de cuisine . Misturadora de cozinha

KOPA ARC . 513400129

Fireclay sink.
Evier en Céramique.
Lava-Louça em Fireclay

Available without overflow
Disponible sans trop-plein
Disponível sem overflow

RENO



7310V

PRODUCT DIMENSIONS

DIMENSIONS DU PRODUIT . DIMENSÕES DO PRODUTO

Overall dimension Dimension totale . Dimensão total	Length Longueur . Comprimento	1000 mm
	Width Largeur . Largura	500 mm
	Height Hauteur . Altura	210 mm
Internal sink size Dimension de l'évier . Dimensão da cuba	Length Longueur . Comprimento	447 mm
	Width Largeur . Largura	412 mm
	Bowl depth Profondeur . Profundidade	190 mm

Cutting plan: 970 x 470 mm

Plan de coupe: 970 x 470 mm . Plano de corte: 970 x 470 mm

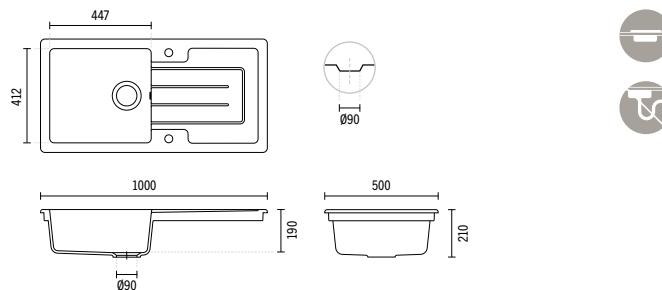

AVAILABLE COLOURS

COULEURS DISPONIBLES . CORES DISPONÍVEIS



White
Blanc . Branco



Matt white
Blanc mat . Branco mate



Matt black
Noir mat . Preto Mate

Available L/R bowl version with waste Ref.7310EV/Ref.7310DV
Disponível en version de 1 cuve G/D avec vidage Ref. 7310EV/Ref.7310DV
Disponível na versão de 1 cuba à E/D com válvula Ref. 7310EV/Ref.7310DV

Available 1 bowl reversible w/2 pre-sketched holes w/waste Ref.7310V
Disponível 1 cuve 1/2 réversible avec 2 percements pré-esquissés et vidage Ref.7310V
Disponível com 1 cuba 1/2 réversible com 2 furos pré-desenhados e válvula Ref.7310V

Waste included Ø90 Ref.4738
Vidage inclus Ø90 Ref.4738 . Válvula incluída Ø90 Ref.4738

U-trap compatible (not included) Ref. 4701
Siphon compatible (non inclus) Ref.4701 . Sifão compatível (não incluído) Ref. 4701

Cover holes compatible (not included) Ref. 47221
Percement de couverture compatible (non inclus) Ref.47221
Tapa-furos compatível (não incluído) Ref. 47221



Inset
À encastrer
Encastrado



U-trap not included
Siphon en U non inclus
Sifão não incluído





RENO

7313

857 X 500 X 215 MM

Kitchen mixer

Mitigeur de cuisine . Misturadora de cozinha

KOPA ARC . 513400113



RENO

7311V

1000 X 500 X 210 MM

Kitchen mixer
Mitigeur de cuisine . Misturadora de cozinha
KOPA SQUARE . 513300129

Fireclay sink.
Evier en Céramique.
Lava-Louça em Fireclay

Available with or without overflow
Disponibile avec ou sans trop-plein
Disponível com ou sem overflow

RENO



7311V

PRODUCT DIMENSIONS

DIMENSIONS DU PRODUIT . DIMENSÕES DO PRODUTO

Overall dimension Dimension totale . Dimensão total	Length Longueur . Comprimento	1000 mm
	Width Largeur . Largura	500 mm
	Height Hauteur . Altura	210 mm
Internal sink size Dimensão da cuba . Dimension de l'évier	Length Longueur . Comprimento	340 170 mm
	Width Largeur . Largura	415 299 mm
	Bowl depth Profondeur . Profundidade	190 140 mm

Cutting plan: 970 x 470 mm

Plan de coupe: 970 x 470 mm . Plano de corte: 970 x 470 mm

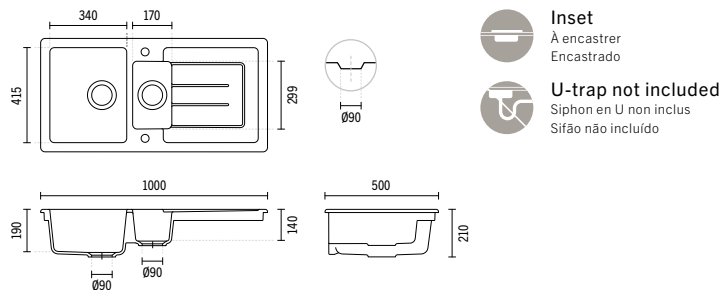

AVAILABLE COLOURS

COULEURS DISPONIBLES . CORES DISPONÍVEIS

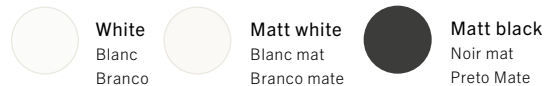

Available L/R bowl version with waste Ref.7311EV/Ref.7311DV

Disponibile en version de 1 cuve G/D avec vidage Ref. 7311EV/Ref.7311DV
Disponível na versão de 1 cuba à E/D com válvula Ref. 7311EV/Ref.7311DV

Available 1 bowl reversible w/2 pre-sketched holes w/waste Ref.7311V

Disponibile 1 cuve 1/2 réversible avec 2 percements pré-esquissés et vidage Ref.7311V
Disponível com 1 cuba 1/2 réversible com 2 furos pré-desenhados e válvula Ref.7311V

Waste included Ø90 Ref.4703

Vidage inclus Ø90 Ref.4703 . Válvula incluída Ø90 Ref.4703

U-trap compatible (not included) Ref. 4703

Siphon compatible (non inclus) Ref.4703 . Sifão compatível (não incluído) Ref. 4703

Cover holes compatible (not included) Ref. 47221

Percement de couverture compatible (non inclus) Ref.47221

Tapa-furos compatível (não incluído) Ref. 47221

Sink without overflow . Évier sans trop-plein . Lava-louça sem overflow



7313V

PRODUCT DIMENSIONS

DIMENSIONS DU PRODUIT . DIMENSÕES DO PRODUTO

Overall dimension Dimension totale . Dimensão total	Length Longueur . Comprimento	857 mm
	Width Largeur . Largura	500 mm
	Height Hauteur . Altura	215 mm
Internal sink size Dimension de l'évier . Dimensão da cuba	Length Longueur . Comprimento	417 mm
	Width Largeur . Largura	412 mm
	Bowl depth Profondeur . Profundidade	190 mm

Cutting plan: 835 x 475 mm

Plan de coupe: 835 x 475 mm . Plano de corte: 835 x 475 mm

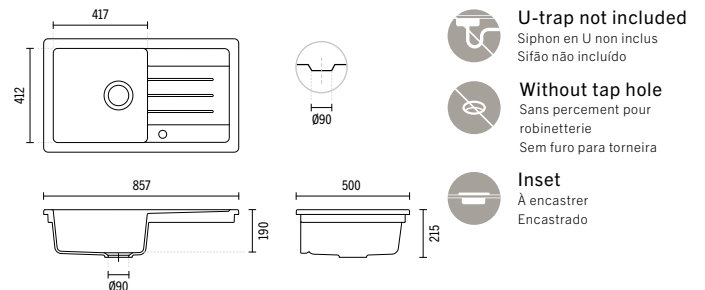

AVAILABLE COLOURS

COULEURS DISPONIBLES . CORES DISPONÍVEIS

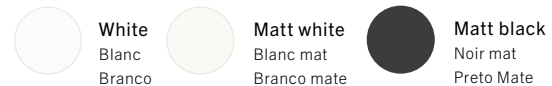

Available L/R bowl version with waste Ref.7313EV/Ref.7313DV

Disponibile en version de 1 cuve G/D avec vidage Ref. 7313EV/Ref.7313DV
Disponível na versão de 1 cuba à E/D com válvula Ref. 7313EV/Ref.7313DV

Available 1 bowl reversible w/2 pre-sketched holes w/waste

Disponibile 1 cuve 1/2 réversible avec 2 percements pré-esquissés et vidage
Disponível com 1 cuba 1/2 réversible com 2 furos pré-desenhados e válvula

Waste included Ø90 Ref.4738

Vidage inclus Ø90 Ref.4738 . Válvula incluída Ø90 Ref.4738

U-trap compatible (not included) Ref. 4701

Siphon compatible (non inclus) Ref.4701 . Sifão compatível (não incluído) Ref. 4701

Cover holes compatible (not included) Ref. 47221

Percement de couverture compatible (non inclus) Ref.47221

Tapa-furos compatível (não incluído) Ref. 47221

Sink with overflow . Évier avec trop-plein . Lava-louça com overflow



LUSITANO



7220

850 X 500 X 200 MM

Kitchen mixer
Mistigeur de cuisine . Misturadora de cozinha
TORUS . 537410111



LUSITANO

7221

995 X 497 X 235 MM

Kitchen mixer
Mitigeur de cuisine . Misturadora de cozinha

ALFA . 500330111

Fireclay sink.
Evier en Céramique.
Lava-Louça em Fireclay

Available with or without overflow
Disponível avec ou sans trop-plein
Disponível com ou sem overflow

LUSITANO



7220

PRODUCT DIMENSIONS

DIMENSIONS DU PRODUIT . DIMENSÕES DO PRODUTO

Overall dimension Dimension totale . Dimensão total	Length Longueur . Comprimento	850 mm
	Width Largeur . Largura	500 mm
	Height Hauteur . Altura	225 mm
Internal sink size Dimension de l'évier . Dimensão da cuba	Length Longueur . Comprimento	340 mm
	Width Largeur . Largura	370 mm
	Bowl depth Profondeur . Profundidade	200 mm

Cutting plan: 810 x 460 mm

Plan de coupe: 810 x 460 mm . Plano de corte: 810 x 460 mm

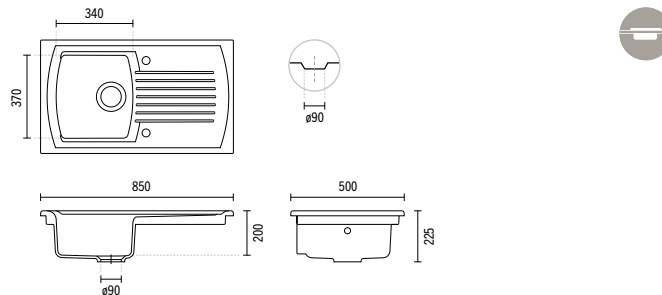

AVAILABLE COLOURS

COULEURS DISPONIBLES . CORES DISPONÍVEIS

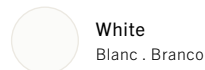

Waste available Ø90 Ref. 4714
Vidage disponible Ø90 Ref. 4714 . Válvulas disponível Ø90 Ref. 4714

Pre-sketched drilling
Percements amorcés pour robinetterie monotrou .
Com furação pré-esboçada para torneira

Cover holes Ref. 47221
Bouchon d'évier pour trou robinet Ref.47221 . Tapa-furos Ref. 47221

Sink with overflow
Évier avec trop-plein . Lava-louça com overflow.



7221

PRODUCT DIMENSIONS

DIMENSÕES DO PRODUTO . DIMENSIONS DU PRODUIT

Overall dimension Dimensão total . Dimension totale	Length Comprimento . Longueur	995 mm
	Width Largura . Largeur	497 mm
	Height Altura . Hauteur	235 mm
Internal sink size Dimensão da cuba . Dimension de l'évier	Length Comprimento . Longueur	330 135 mm
	Width Largura . Largeur	370 259 mm
	Bowl depth Profundidade . Profondeur	218 127 mm

Cutting plan: 950 x 460 mm

Plan de coupe: 950 x 460 mm . Plano de corte: 950 x 460 mm

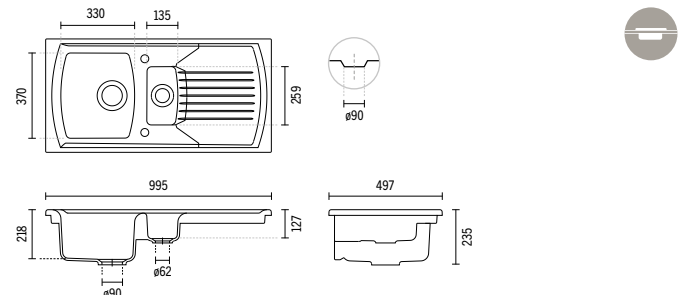

AVAILABLE COLOURS

COULEURS DISPONIBLES . CORES DISPONÍVEIS

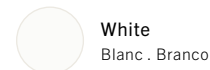

Waste available Ø90 Ref. 4821
Vidage disponible Ø90 Ref. 4821 . Válvula disponível Ø90 Ref. 4821

Pre-sketched drilling
Percements amorcés pour robinetterie monotrou .
Com furação pré-esboçada p/ torneira

Cover holes Ref. 47221
Bouchon d'évier pour trou robinet Ref.47221 . Tapa-furos Ref. 47221

Sink without overflow
Évier sans trop-plein . Lava-louça sem overflow.







LUSITANO

7223

860 X 500 X 220 MM

Kitchen mixer
Mitigeur de cuisine . Misturadora de cozinha
ADVANCE . 527300111



LUSITANO

7222

1205 X 500 X 222 MM

Kitchen mixer
Mitigeur de cuisine . Misturadora de cozinha

KOPA SQUARE . 513300129

Fireclay sink.
Evier en Céramique.
Lava-Louça em Fireclay

Available with overflow
Disponible avec trop-plein
Disponível com overflow

LUSITANO



7222

PRODUCT DIMENSIONS

DIMENSIONS DU PRODUIT . DIMENSÕES DO PRODUTO

Overall dimension Dimension totale . Dimensão total	Length Longueur . Comprimento	1205 mm
	Width Largeur . Largura	500 mm
	Height Hauteur . Altura	222 mm
Internal sink size Dimension de l'évier . Dimensão da cuba	Length Longueur . Comprimento	335 335 mm
	Width Largeur . Largura	373 mm
	Bowl depth Profondeur . Profundidade	200 mm

Cutting plan: 1170 x 465 mm

Plan de coupe: 1170 x 465 mm . Plano de corte: 1170 x 465 mm

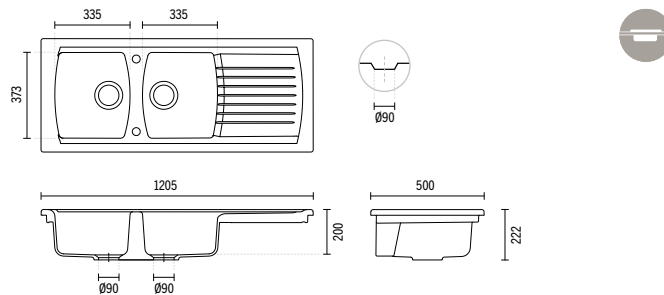

AVAILABLE COLOURS

COULEURS DISPONIBLES . CORES DISPONÍVEIS



Waste available Ø90 Ref. 4616

Vidage disponible Ø90 Ref. 4716 . Válvula disponível Ø90 Ref. 4716

Pre-sketched drilling

Percements amorcés pour robinetterie monotrou .
Com furação pré-esboçada para torneira

Cover holes Ref. 47221

Bouchon d'évier pour trou robinet Ref.47221 . Tapa-furos Ref. 47221

Sink without overflow

Évier sans trop-plein . Lava-louça sem overflow.



7223

PRODUCT DIMENSIONS

DIMENSIONS DU PRODUIT . DIMENSÕES DO PRODUTO

Overall dimension Dimension totale . Dimensão total	Length Longueur . Comprimento	860 mm
	Width Largeur . Largura	500 mm
	Height Hauteur . Altura	220 mm
Internal sink size Dimension de l'évier . Dimensão da cuba	Length Longueur . Comprimento	356 356 mm
	Width Largeur . Largura	380 mm
	Bowl depth Profondeur . Profundidade	200 mm

Cutting plan: 810 x 460 mm

Plan de coupe: 810 x 460 mm . Plano de corte: 810 x 460 mm

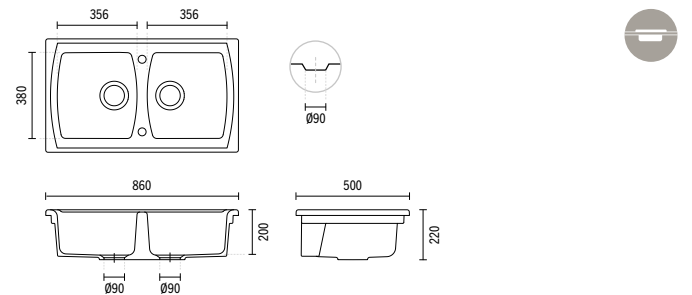

AVAILABLE COLOURS

COULEURS DISPONIBLES . CORES DISPONÍVEIS

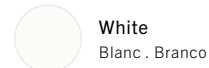

Waste available Ø90 Ref. 4716

Vidage disponible Ø90 Ref. 4716 . Válvula disponível Ø90 Ref. 4716

Pre-sketched drilling

Percements amorcés pour robinetterie monotrou .
Com furação pré-esboçada p/ torneira

Cover holes Ref. 47221

Bouchon d'évier pour trou robinet Ref.47221 . Tapa-furos Ref. 47221

Sink without overflow

Évier sans trop-plein . Lava-louça sem overflow.



Inset
À encastrer
Encastrado



VALET



7340V

462 X 462 X 220 MM

Kitchen mixer

Mitigeur de cuisine . Misturadora de cozinha

ADVANCE . 527300111



VALET

7340V

462 X 462 X 220 MM

Kitchen mixer
Misturadora de cozinha . Mitigeur de cuisine

KOPA SQUARE . 513300113

Fireclay sink.
Evier en Céramique.
Lava-Louça em Fireclay

Available without overflow
Disponível sans trop-plein
Disponível sem overflow



7330V

PRODUCT DIMENSIONS

DIMENSIONS DU PRODUIT . DIMENSÕES DO PRODUTO

Overall dimension Dimension totale . Dimensão total	Length Longueur . Comprimento	237 mm
	Width Largeur . Largura	462 mm
	Height Hauteur . Altura	223 mm
Internal sink size Dimension de l'évier . Dimensão da cuba	Length Longueur . Comprimento	174 mm
	Width Largeur . Largura	400 mm
	Bowl depth Profondeur . Profundidade	195 mm

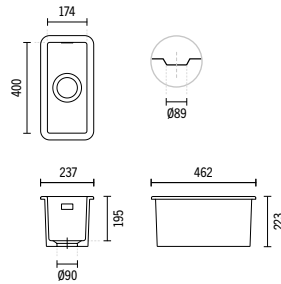

AVAILABLE COLOURS

COULEURS DISPONIBLES . CORES DISPONÍVEIS

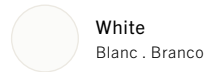

ACCESSORIES

ACCESSOIRES . ACESSÓRIOS

Dish in stainless steel
Égouttoir en acier inoxydable
Escorredor em aço inoxidável



4A330

442x209x144 mm



VALET



7340V

PRODUCT DIMENSIONS

DIMENSÕES DO PRODUTO . DIMENSIONS DU PRODUIT

Overall dimension Dimension totale . Dimensão total	Length Longueur . Comprimento	462 mm
	Width Largeur . Largura	462 mm
	Height Hauteur . Altura	220 mm
Internal sink size Dimension de l'évier . Dimensão da cuba	Length Longueur . Comprimento	400 mm
	Width Largeur . Largura	400 mm
	Bowl depth Profondeur . Profundidade	195 mm

Cutting plan: 440 x 440 mm (inset) . 390 x 390 mm (undermount)

Plan de coupe: 440 x 440 mm (encastrer) . 390 x 390 mm (par-dessous)

Plano de corte encastrado: 440 x 440 mm (por cima) . 390 x 390 mm (por baixo)

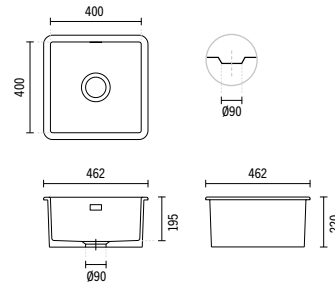

AVAILABLE COLOURS

CORES DISPONÍVEIS . COULEURS DISPONIBLES



ACCESSORIES

ACCESSOIRES . ACESSÓRIOS

Grid in stainless steel
Grille en acier inoxydable
Grelha em aço inoxidável

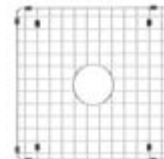

4A340

374x374x28 mm

Waste included Ø90 Ref.473511

Vidage inclus Ø90 Ref.473511

Válvula incluída Ø90 Ref.473511

U-trap compatible Ref. 4701

Siphon compatible Ref.4701

Sifão compatível Ref. 4701

Fixing Kit Ref. 45 (not included)

Kit de fixação Ref.45 (non inclus)

Kit de fixação Ref. 45 (não incluído)





VALET

7350V | 7330V

601 X 462 X 222MM | 237 X 462 X 223 MM

Kitchen mixer
Mítigeur de cuisine . Misturadora de cozinha
TORUS . 537300111



VALET

7350V

601 X 462 X 222 MM

Kitchen mixer
Mitigeur de cuisine . Misturadora de cozinha

KOPA SQUARE . 513300129

Fireclay sink.
Evier en Céramique.
Lava-Louça em Fireclay

Available without overflow
Disponível sans trop-plein
Disponível sem overflow

VALET



7350V

PRODUCT DIMENSIONS

DIMENSIONS DU PRODUIT . DIMENSÕES DO PRODUTO

Overall dimension Dimension totale . Dimensão total	Length Longueur . Comprimento	601 mm
	Width Largeur . Largura	462 mm
	Height Hauteur . Altura	222 mm
Internal sink size Dimension de la cuba . Dimension de l'évier	Length Longueur . Comprimento	540 mm
	Width Largeur . Largura	401 mm
	Bowl depth Profondeur . Profundidade	195 mm

Cutting plan: 575 x 440 mm (inset) . 532 x 392 mm (undermount)

Plan de coupe: 575 x 440 mm (encastrer) . 532 x 392 mm (par-dessous)

Plano de corte encastrado: 575 x 440 mm (por cima) . 532 x 392 mm (por baixo)

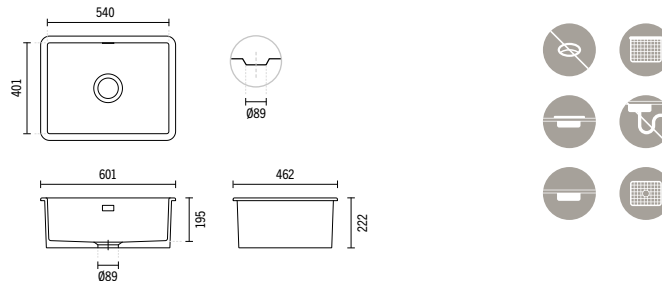

AVAILABLE COLOURS

COULEURS DISPONIBLES . CORES DISPONÍVEIS

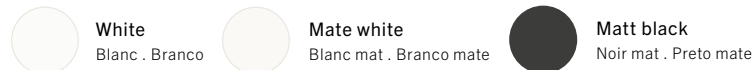

ACCESSORIES

ACCESSOIRES . ACESSÓRIOS

Accessories in stainless steel

Accessoires en acier inoxydable . Acessórios em aço inoxidável

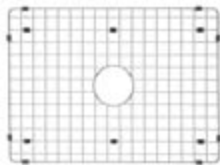

4A350

512x377x28mm



4A330

442x209x144mm

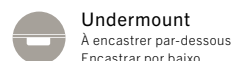
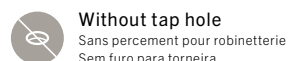

7360V

PRODUCT DIMENSIONS

DIMENSIONS DU PRODUIT . DIMENSÕES DO PRODUTO

Overall dimension Dimension totale . Dimensão total	Length Longueur . Comprimento	596 mm
	Width Largeur . Largura	522 mm
	Height Hauteur . Altura	223 mm
Internal sink size Dimension de l'évier . Dimensão da cuba	Length Longueur . Comprimento	356 164 mm
	Width Largeur . Largura	460 300 mm
	Bowl depth Profondeur . Profundidade	195 mm

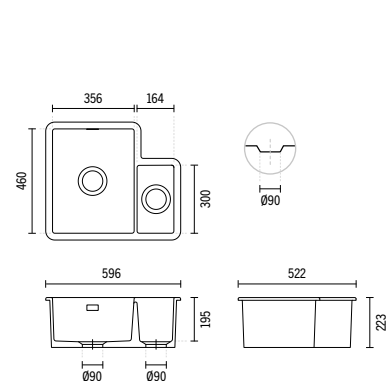

AVAILABLE COLOURS

COULEURS DISPONIBLES . CORES DISPONÍVEIS

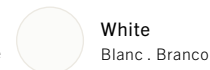

ACCESSORIES

ACCESSOIRES . ACESSÓRIOS

Grid in stainless steel . Grille en acier inoxydable . Grelha em aço inoxidável

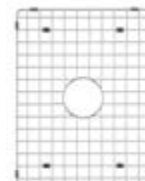

4A360

436x331x28mm

Waste included Ø90 Ref.4736
Vidage inclus Ø90 Ref.4736
Válvula incluída Ø90 Ref.4736
U-trap compatible Ref. 4704
Siphon compatible Ref.4704
Sifão compatível Ref. 4704
Fixing Kit Ref. 45 (not included)
Kit de fixação Ref. 45 (não incluído)





VALET

7360

596 X 522 X 223 MM

Kitchen mixer
Mítigeur de cuisine . Misturadora de cozinha
TORUS . 537300111



7370
595 X 460 MM

Kitchen mixer
Misturadora de cozinha .Mitigeur de cuisine
KOPA SQUARE . 513300113

Fireclay sink.
Evier en Céramique.
Lava-Louça em Fireclay

Available without overflow
Disponible sans trop-plein
Disponível sem overflow

VALET



7370V

PRODUCT DIMENSIONS

DIMENSIONS DU PRODUIT . DIMENSÕES DO PRODUTO

Overall dimension Dimension totale . Dimensão total	Length Longueur . Comprimento	595 mm
	Width Largeur . Largura	460 mm
	Height Hauteur . Altura	220 mm
Internal sink size Dimension de l'évier . Dimensão da cuba	Length Longueur . Comprimento	337 183 mm
	Width Largeur . Largura	400 mm
	Bowl depth Profondeur . Profundidade	195 mm

Cutting plan: 575 x 440 mm (inset) . 532 x 392 mm (undermount)

Plan de coupe: 575 x 440 mm (encastrer) . 532 x 392 mm (par-dessous)

Plano de corte encastrado: 532 x 392 mm (por cima) . 532 x 392 mm (por baixo)

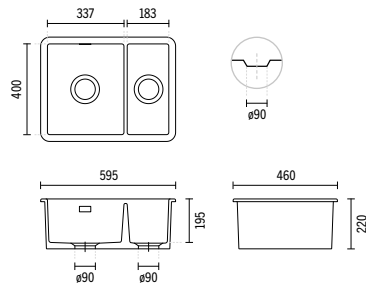

AVAILABLE COLOURS

COULEURS DISPONIBLES . CORES DISPONÍVEIS



ACCESSORIES

ACCESSOIRES . ACESSÓRIOS

Accessories in stainless steel

Accessoires en acier inoxydable . Acessórios em aço inoxidável

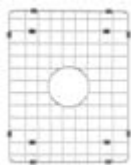

4A370

373x295x28mm



4A330

442x209x144 mm

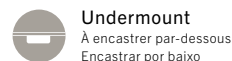

7390V

PRODUCT DIMENSIONS

DIMENSÕES DO PRODUTO . DIMENSIONS DU PRODUIT

Overall dimension Dimensão total . Dimension totale	Length Comprimento . Longueur	555 mm
	Width Largura . Largeur	430 mm
	Height Altura . Hauteur	220 mm
Internal sink size Dimensão da cuba . Dimension de l'évier	Length Comprimento . Longueur	330 150 mm
	Width Largura . Largeur	370 mm
	Bowl depth Profundidade . Profondeur	195 mm

Cutting plan: 575 x 440 mm (inset) . 532 x 392 mm (undermount)

Plan de coupe: 575 x 440 mm (encastrer) . 532 x 392 mm (par-dessous)

Plano de corte encastrado: 532 x 392 mm (por cima) . 532 x 392 mm (por baixo)

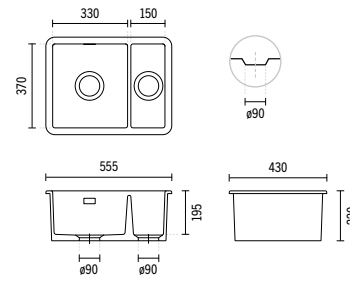

AVAILABLE COLOURS

COULEURS DISPONIBLES . CORES DISPONÍVEIS



ACCESSORIES

ACCESSOIRES . ACESSÓRIOS

Dish in stainless steel

Égouttoir en acier inoxydable . Escorredor em aço inoxidável



4A330

442x209x144 mm



Waste included Ø90
Ref.4736

Vidage inclus Ø90 Ref.4736
Válvula incluída Ø90 Ref.4736

U-trap compatible
Ref. 4704

Siphon compatible Ref.4704

Sifão compatível Ref. 4704

Fixing Kit Ref. 45
(not included)

Kit de fixação Ref.45
(non inclus)

Kit de fixação Ref. 45
(não incluído)

Waste included Ø90 Ref.4736

Vidage inclus Ø90 Ref.4736

Válvula incluída Ø90 Ref.4736

U-trap compatible Ref. 4704

Siphon compatible Ref.4704

Sifão compatível Ref. 4704

Fixing Kit Ref. 45 (not included)

Kit de fixação Ref.45 (non inclus)

Kit de fixação Ref. 45 (não incluído)



VALET

7620V

796 X 462 X 223 MM

Kitchen mixer
Mitigeur de cuisine . Misturadora de cozinha

TORUS . 537420111

Fireclay sink.
Evier en Céramique.
Lava-Louça em Fireclay

Available without overflow
Disponible sans trop-plein
Disponível sem overflow

VALET



7620V

PRODUCT DIMENSIONS

DIMENSIONS DU PRODUIT . DIMENSÕES DO PRODUTO

Overall dimension Dimension totale . Dimensão total	Length Longueur . Comprimento	796 mm
	Width Largeur . Largura	462 mm
	Height Hauteur . Altura	223 mm
Internal sink size Dimension de l'évier . Dimensão da cuba	Length Longueur . Comprimento	431 286 mm
	Width Largeur . Largura	401 mm
	Bowl depth Profondeur . Profundidade	100 mm

Cutting plan: 775 x 435 mm (inset) . 725 x 390 mm (undermount)

Plan de coupe: 775 x 435 mm (encastrer) . 725 x 390 mm (par-dessous)

Plano de corte encastrado: 775 x 390 mm (por cima) . 725 x 390 mm (por baixo)

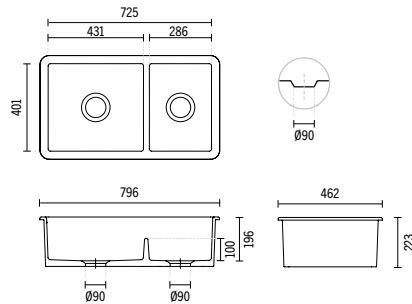

AVAILABLE COLOURS

COULEURS DISPONIBLES . CORES DISPONÍVEIS

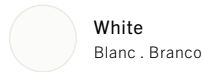

ACCESSORIES

ACCESSOIRES . ACESSÓRIOS

Grids in stainless steel

Grilles en acier inoxydable . Grelhas em aço inoxidável

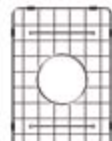
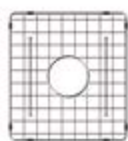

4A620

405x371x30 mm

4A621

258x371x30 mm

Waste included Ø90 Ref.4736

Vidage inclus Ø90 Ref.4736 . Válvula incluída Ø90 Ref.4736

U-trap compatible Ref. 4704

Siphon compatible Ref.4704 . Sifão compatível Ref. 4704

Fixing Kit Ref. 45 (not included)

Kit de fixação Ref.45 (non inclus) . Kit de fixação Ref. 45 (não incluído)



Without tap hole
Sans percement pour robinetterie
Sem furo para torneira



Inset
À encastrer
Encastrar



Undermount
À encastrer par-dessous
Encastrar por baixo



U-trap not included
Siphon en U non inclus
Sifão não incluído



Grid
Grille
Grelha



VALET

7380V

Ø445 X 197 MM

Kitchen mixer
Mitigeur de cuisine . Misturadora de cozinha

TORUS . 537310111

Fireclay sink.
Evier en Céramique.
Lava-Louça em Fireclay

Available without overflow
Disponible sans trop-plein
Disponível sem overflow

VALET



7380V

PRODUCT DIMENSIONS

DIMENSIONS DU PRODUIT . DIMENSÕES DO PRODUTO

Overall dimension Dimension totale . Dimensão total	Diameter Diamètre . Diâmetro	Ø445 mm
	Height Hauteur . Altura	197 mm
Internal bowl size Dimension de l'évier . Dimensão da cuba	Diameter Diamètre . Diâmetro	Ø385 mm
	Depth Profondeur . Profundidade	174 mm

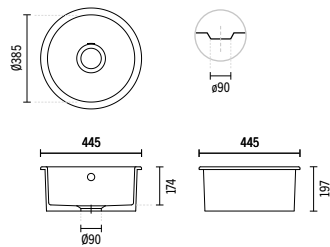

AVAILABLE COLOURS

COULEURS DISPONIBLES . CORES DISPONÍVEIS



White
Blanc . Branco

Waste included Ø90 Ref.4738

Vidage inclus Ø90 Ref.4738 . Válvula incluída Ø90 Ref.4738

U-trap compatible Ref. 4701

Siphon compatible Ref.4701 . Sifão compatível Ref. 4701

Fixing Kit Ref. 45 (not included)

Kit de fixation Ref.45 (non inclus) . Kit de fixação Ref. 45 (não incluído)



Without tap hole
Sans percement pour robinetterie
Sem furo para torneira



Inset
À encastrer
Encastrar



Undermount
À encastrer par-dessous
Encastrar por baixo



U-trap not included
Siphon en U non inclus
Sifão não incluído



BELFAST

7400V

595 X 455 X 252 MM

Kitchen mixer
Mitigeur de cuisine . Misturadora de cozinha

TORUS . 537400111

Fireclay sink.
Evier en Céramique.
Lava-Louça em Fireclay

Available without overflow
Disponible sans trop-plein
Disponível sem overflow

BELFAST



7400V

PRODUCT DIMENSIONS

DIMENSIONS DU PRODUIT . DIMENSÕES DO PRODUTO

Overall dimension Dimension totale . Dimensão total	Length Longueur . Comprimento	595 mm
	Width Largeur . Largura	455 mm
	Height Hauteur . Altura	252 mm
Internal sink size Dimension de l'évier . Dimensão da cuba	Length Longueur . Comprimento	535 mm
	Width Largeur . Largura	395 mm
	Bowl depth Profondeur . Profundidade	222 mm

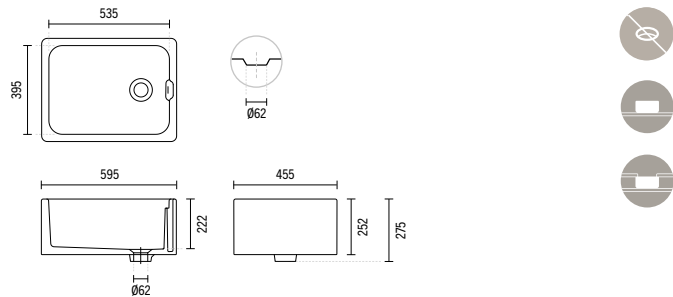

AVAILABLE COLOURS

COULEURS DISPONIBLES . CORES DISPONÍVEIS



White
Blanc . Branco



Matt white
Blanc mat . Branco mate



Matt anthracite
Anthracite Mate . Antracite mate

Waste included Ø62 Ref.4740

Vidage inclus Ø62 Ref.4740 . Válvula incluída Ø62 Ref.4740

U-trap compatible Ref. 4730

Siphon compatible Ref.4730 . Sifão compatível Ref. 4730



Without tap hole
Sans percement pour robinetterie
Sem furo para torneira



Countertop
Poser
Pousar



Apron Front
Evier à poser sous plan
Pousar abaixo do nível da bancada



TROIA

7071V

1125 X 500 X 215 MM

Kitchen mixer
Mitigeur de cuisine . Misturadora de cozinha

ALFA . 500330111

Fireclay sink.
Evier en Céramique.
Lava-Louça em Fireclay

Available without overflow
Disponible sans trop-plein
Disponível sem overflow

TROIA



7071V

PRODUCT DIMENSIONS

DIMENSIONS DU PRODUIT . DIMENSÕES DO PRODUTO

Overall dimension Dimension totale . Dimensão total	Length Longueur . Comprimento	1125 mm
	Width Largeur . Largura	500 mm
	Height Altura . Hauteur	215 mm
Internal sink size Dimension de l'évier . Dimensão da cuba	Length Longueur . Comprimento	382 270 mm
	Width Largeur . Largura	378 mm
	Bowl depth Profondeur . Profundidade	191 mm

Cutting plan: 1095 x 475 mm

Plan de coupe: 1095 x 475 mm . Plano de corte: 1095 x 475 mm

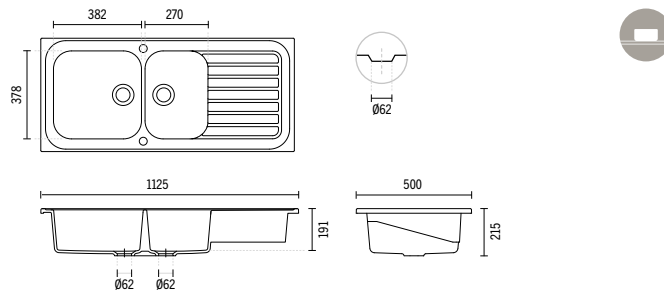

AVAILABLE COLOURS

COULEURS DISPONIBLES . CORES DISPONÍVEIS



Waste included Ø62 Ref.4707

Vidage inclus Ø62 Ref.4707 . Válvula incluída Ø62 Ref.4707

Pre-sketched drilling

Trous amorcés pour robinetterie monotrou . Com furação pré-esboçada para torneira

Cover holes Ref. 47221

Bouchon d'évier pour percement robinet réf. 47221 . Tapa-furos Ref. 47221

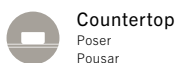





UTILITY

7410V

510 X 506 X 235 MM

Kitchen mixer

Mitigeur de cuisine . Misturadora de cozinha

MASTER 40 . 525300111



UTILITY

7411V

660 X 506 X 236 MM

Kitchen mixer
Mitigeur de cuisine . Misturadora de cozinha

TORUS . 537410111

Fireclay sink.
Evier en Céramique.
Lava-Louça em Fireclay

Available without overflow
Disponible sans trop-plein
Disponível sem overflow

UTILITY



7410V

PRODUCT DIMENSIONS

DIMENSIONS DU PRODUIT . DIMENSÕES DO PRODUTO

Overall dimension Dimension totale . Dimensão total	Length Longueur . Comprimento	510 mm
	Width Largeur . Largura	506 mm
	Height Hauteur . Altura	235 mm
Internal sink size Dimension de la cuba . Dimension de l'évier	Length Longueur . Comprimento	449 mm
	Width Largeur . Largura	357 mm
	Bowl depth Profondeur . Profundidade	210 mm

Cutting plan: 486 x 482 mm
Plan de coupe: 486 x 482 mm
Plano de corte encastrado: 486 x 482 mm

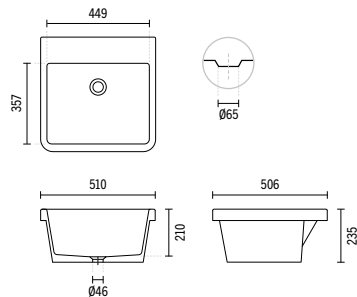

AVAILABLE COLOURS

COULEURS DISPONIBLES . CORES DISPONÍVEIS



Waste included Ø65 Ref. 4V91

Vidage inclus Ø65 Ref. 4V91

Válvula incluída Ø65 Ref. 4V91

U-trap compatible (not included) Ref. 4V95

Siphon compatible (non inclus) Ref. 4V95

Sifão compatível (não incluído) Ref. 4 4V95

Tap hole

Perçement de robinet

Furação para torneira



7411V

PRODUCT DIMENSIONS

DIMENSIONS DU PRODUIT . DIMENSÕES DO PRODUTO

Overall dimension Dimension totale . Dimensão total	Length Longueur . Comprimento	660 mm
	Width Largeur . Largura	506 mm
	Height Hauteur . Altura	236 mm
Internal sink size Dimension de l'évier . Dimensão da cuba	Length Longueur . Comprimento	599 mm
	Width Largeur . Largura	357 mm
	Bowl depth Profondeur . Profundidade	210 mm

Cutting plan: 631 x 446 mm
Plan de coupe: 631 x 446 mm
Plano de corte encastrado: 631 x 446 mm

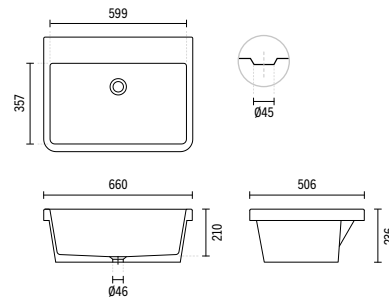

AVAILABLE COLOURS

COULEURS DISPONIBLES . CORES DISPONÍVEIS

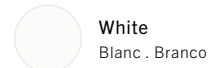

Waste included Ø45 Ref. 4V91

Vidage inclus Ø45 Ref. 4V91

Válvula incluída Ø45 Ref. 4V91

U-trap compatible (not included) Ref. 4V95

Siphon compatible (non inclus) Ref. 4V95

Sifão compatível (não incluído) Ref. 4 4V95

Tap hole

Perçement de robinet

Furação para torneira



BUILT FOR LONGEVITY DESIGNED FOR TRUST

ALL SANINDUSA SINKS HAVE A PERMANENT WARRANTY

Our sink dimensions can vary by a plus or minus of 2%, as some shrinking can happen during firing.

We recommend a specialist kitchen fitter installs your sink; no work surfaces or cabinets should be cut before measuring your sink; must also be assured that it is properly supported.

Please see our **website for details** of our sinks, taps and accessories.

Les dimensions de nos éviers peuvent varier de plus ou moins 2 %, car un certain rétrécissement peut se produire pendant la cuisson.

Nous recommandons qu'un installateur de cuisine spécialisé installe votre évier ; aucune surface de travail ou armoire ne doit être coupée avant de mesurer votre évier ; assurez-vous également que l'évier soit correctement soutenu.

Veillez consulter notre **site Web pour plus de détails** sur nos éviers, mitigeurs et accessoires.

As dimensões dos nossos lava-loiças podem variar +/- 2% devido ao processo de cozedura.

Recomendamos que um profissional especializado instale o seu lava-loiça; nenhuma superfície de trabalho ou armário deve ser cortado antes de medir o seu lava-loiça; também deve assegurar de que está devidamente apoiado.

Por favor, consulte o nosso **site para obter detalhes** dos nossos lava-loiças, torneiras e acessórios.



SANINDUSA

THE PATH OF WATER

Z.I. Aveiro Sul . P.O.Box 43
3811-901 Aveiro, Portugal
+351 234 940 250

(CHAMADA P/ A REDE FIXA NACIONAL . PORTUGUESE LANDLINE NETWORK CALL)

sanindusa.com . sanindusa@sanindusa.com



08.2004

